

TOY - MAKING
IN SCHOOL AND HOME



PLATE I

A SCENE IN TOYLAND

Fr.

TOY-MAKING IN SCHOOL AND HOME

By

R. K. & M. I. R. POLKINGHORNE

THE COUNTY SECONDARY SCHOOL STREATHAM

UNIV. OF
CALIFORNIA

LONDON

GEORGE G. HARRAP & COMPANY

2 & 3 PORTSMOUTH STREET KINGSWAY W.C.

1916

TT169
P7

TO VINDU
AMPHOTILLAO

Prefatory Note

THE authors wish to express their thanks to Mr J. E. Mansion for many valuable criticisms and suggestions, and to Miss Bassett, whose encouragement and support alone made the work possible.

Contents

| | PAGE |
|---|------|
| INTRODUCTION. <i>By Miss R. BASSETT, B.A., Headmistress of the County Secondary School, Streatham</i> | 9 |

PART I

TOYS FOR LITTLE ONES: PAPER AND CARDBOARD

| CHAPTER | | PAGE |
|--|--|------|
| I. TOY-MAKING AND ITS EDUCATIONAL POSSIBILITIES | | 21 |
| II. GENERAL PRINCIPLES; MATERIALS | | 26 |
| III. PAPER WORK FOR INFANTS | | 31 |
| IV. MORE PAPER TOYS | | 43 |
| V. MATCH-BOX TOYS | | 53 |
| VI. MORE COMPLICATED MATCH-BOX AND CORK TOYS | | 64 |
| VII. CORK ANIMALS HARNESSSED TO SLEDGES, ETC. | | 72 |
| VIII. MORE CORK TOYS | | 80 |
| IX. CARDBOARD AND PAPER SHIPS | | 86 |
| X. CARDBOARD AND PAPER TOYS | | 91 |
| XI. SIMPLE WOODWORK | | 98 |
| XII. MATERIALS | | 102 |
| XIII. SOME DIFFICULTIES IN TOY-MAKING | | 105 |
| XIV. MERRY-GO-ROUND, SWINGING BOATS, AND GREAT WHEEL | | 109 |
| XV. FLYING AIRSHIPS, GONDOLAS, AND BIRDS | | 113 |
| XVI. FIRE-ENGINE, MOTOR-LORRY, AND STEAM-ROLLER | | 119 |
| XVII. GIPSY CARAVAN AND BATHING MACHINE | | 123 |
| XVIII. A TRAIN AND RAILWAY STATION | | 125 |
| XIX. RED CROSS MOTOR AND TAXI-CAB | | 131 |
| XX. SWINGING AND JOINTED ANIMALS | | 136 |

PART II

TOYS OF CARDBOARD AND WOOD:
MECHANICAL TOYS

| CHAPTER | PAGE |
|---|------|
| I. ADDITIONAL TOOLS | 145 |
| II. CAPSTAN, DREADNOUGHT, LINER | 148 |
| III. MOTOR-CAR, SWINGING CRADLE, DECK-CHAIR | 152 |
| IV. A TRAM-CAR | 155 |
| V. A CRANE | 159 |
| VI. WINDMILL, WATER-WHEEL, WELL | 161 |
| VII. DRAWBRIDGE AND SIEGE TOWER | 168 |
| VIII. WAR ENGINES PAST AND PRESENT | 171 |
| IX. A FIRE-ESCAPE | 181 |
| X. CASTLE, TOURNAMENT, AND FAIR | 184 |
| XI. AN OLD CHARIOT AND SOME QUAIN'T DOLLS' FURNITURE | 190 |
| XII. RAILWAY SIGNAL AND SIGNAL-BOX | 195 |
| XIII. LIGHTHOUSE, TRANSPORTER BRIDGE | 199 |
| XIV. YACHTS AND BOATS: THE USE OF THE CHISEL | 203 |
| XV. THE FRET-SAW | 209 |
| XVI. LITTLE GYMNAST, DANCING CLOWN, ROCKING ANIMALS | 212 |
| XVII. MOVING FIGURES | 218 |
| XVIII. SOME OLD-FASHIONED TOYS | 221 |
| XIX. LITTLE SWORDSMEN | 225 |
| XX. SOME MORE FRET-SAW TOYS | 229 |
| XXI. TOYS WORKED BY SAND | 235 |
| XXII. TOYS WORKED BY WHEELS, ETC. | 243 |
| XXIII. KITES, GLIDERS, AND AEROPLANES | 249 |
| XXIV. MORE OLD-FASHIONED TOYS | 260 |
| XXV. LIFT, PONT ROULANT, TOWER BRIDGE | 267 |
| XXVI. SOLDERING. SCREW STEAMER. TOYS WORKED BY WIND AND BY CONVECTION CURRENTS | 278 |
| XXVII. BUILDINGS AT HOME AND ABROAD | 286 |
| XXVIII. A THEATRE | 295 |

Introduction

By R. BASSETT, B.A.

HEADMISTRESS, COUNTY SECONDARY SCHOOL, STREATHAM

I. EXTERNAL EVIDENCE

WOMEN are often limited in their amusements and in their hobbies for lack of power or of knowledge to use the requisite implements. We may wield the needle, the brush, kitchen utensils, even the spade and the trowel, but what knowledge have we of the chisel, the plane, the saw, or even the friendly gimlet and the screw-driver ?

The scissors answer many purposes until the points are broken, but how helpless we are with a screw or a saw, how futile are our attempts to adjust a loose door-handle, or to set the knives of a mowing machine ! It is humiliating to call for help in such simple jobs, and tantalizing not to be able to enjoy the carpenter's bench as our men-folk do in their hours of leisure.

A really active hobby, one entailing exercise of many muscles, otherwise resting, does help to keep a well-balanced mind and a healthy body. It saves one from fretfulness, from too great introspection ; it keeps one cheerful and changes one's attitude of mind when change is needed.

It is possible that the management of big things falls into men's hands because from babyhood they have dealt with larger things than women, and through handling manageable things from an early age have developed the constructive faculty more thoroughly. The little girl deals with ' wee ' things : stitches are small, dolls are small ; there is a fatal tendency sometimes to ' niggle,' to ' finick '—not that men-folk are immune from this—to love uniformity and tidiness for their own sakes, to seek regularity rather than utility. The little girl, however, must, unless she is too thoroughly

10 TOY-MAKING IN SCHOOL AND HOME

supervised, exercise some ingenuity in planning a doll's dress out of a cutting from the rag-bag ; but her amusements and hobbies tend to pin her down to small things, and she does not rise far enough from her immediate surroundings. The dress of her little doll will follow the prevailing fashion. Originality in dress is eccentricity.

The girl takes pains to carry out her work (neatness is often the sole aim put before her), the boy finds methods. The girl hovers round the well-known place, the boy makes a bee-line to fresh fields. See how this affects reading : the girl still hankers after *What Katy Did*, *What Katy Did Next*, while the boy of her age is reading Jules Verne or Ballantyne or Henty, or if there is open access to shelves in the Free Library near him, you see him finding books on Airships, Submarines, Carpentry, or Engineering.

We started our voluntary classes with these ideas in mind, and at first allowed girls to choose an indoor occupation in the two winter terms instead of outdoor games. Many girls preferred games, but others chose Art or First Aid or Cookery or Handwork or Needlework. They had to work at least a term at the chosen occupation. We felt that the girls gained great benefit from the hobbies, not only in the additional happiness of working at what they enjoyed, but in an increase of freshness of mind for other work. This year we have gone still farther and have given each girl one period of voluntary work in addition to a whole afternoon for games or gardening ; moreover, the four lowest forms have each one period of class work in toy-making ; yet even now the children say that the time is too short. It is really amusing to see a change of classes in the woodwork-room ; the first class dare not and cannot stay a minute after the bell has rung, for the second class is in and already at work.

I have tried to find out what is the great attraction to the child in the handwork lessons ; the children's appreciation of the subject will be found in Section II. Probably the strongest attractions are : firstly, they see the building up of a piece of work and the result pleases them (at all events, until they do something better) ; secondly, they are actively employed, learning by doing, not learning by listening ; and, lastly, they love the cheerful noise of the hammer and the saw and friendly conversation.

It is hard to estimate the value of handwork in education, for

one cannot separate the influence of one subject in the curriculum, but one is tempted to say that it has a beneficial effect upon the child's attitude toward work in general ; she looks into the why and wherefore of an object in order to see how it is made ; unconsciously she adopts the same attitude toward things abstract. She learns to appreciate accuracy and to detect error, but how far she applies this to subjects other than handwork it is hard to say. It is possible, also, that handwork helps to develop the sense of justice.

Certainly the girl who has had a course in handwork does take a more intelligent interest in things around her, and does find out a way of 'setting about' a piece of work by herself. She has something pleasant and profitable to think about ; she becomes more businesslike ; in the lesson itself she resents interruption (this was the case when the photographer came for illustrations for this book) ; more strangely still, she plays no tricks with glue-pot or tools, although she has innumerable opportunities for mischief. The joy over the finished article is greater than the spirit of mischief. She realizes how short the time is when there is work to be done, and looks out for devices for saving time, putting tools in handy places, saving pieces of wood of useful sizes to avoid sawing, and so on.

There is a spirit of earnest endeavour abroad in the handwork class which prevents a girl from throwing aside in a pet something she has done badly ; she does not give up in disgust ; she finds out the cause of the failure and tries again and again until she gets better results. It is no unusual thing to find a girl return to a job that, five or six weeks before, she had thought finished, and do it again, because her progress with other articles has made her dissatisfied with her previous standard. This comes, not from suggestion from outside, but from the development of the child's own judgment. These are the things which show what is the real value of this training.

II. INTERNAL EVIDENCE

In order to find from internal evidence the educational value of toy-making, the following questions were put to the two lowest classes (ages ten to eleven). The girls were told to write frankly

12 TOY-MAKING IN SCHOOL AND HOME

what they really thought, not what they thought might satisfy the mistress.

To the question, "If you like handwork, say why; if not, say why you do not," out of forty-five papers one answer only was against handwork—"Because I do not like sawing." The answers in favour were of this type :

"Because we can make what we like."

"Because I like sawing and hammering."

"Because it is nice to see the things when they are finished."

"Because you can make interesting things."

"Because it is interesting making things out of wood like boys."

"Because I make useful things."

The favourite tools were the hammer and saw. There was considerable difference of opinion on the question, "Has it done you any good?" A fair number think it has made them careful or patient or more useful; others seem to think that the exercise in sawing has some good effect on the arms; one says her "fingers are better for music." Others see in handwork a pleasant occupation for future grown-up days; another thinks it has made her "not so flabby and fat."

If they admit that it has cured them of any faults (and they are not very ready to do this), the chief are laziness, clumsiness, and carelessness. To the last question, "Will it be of any use to you when you are grown up?" the majority look forward to the joy of mending their little girls' toys. (Not one mentions a little boy; is he expected to mend his own?) Others will make things instead of buying them ready-made. Some look forward to mending broken chairs or door-handles. One says: "It will teach me to earn my fortune," and finally one writes philosophically: "Ordepents." (No! handwork does not cure bad spelling.)

The girls of the next highest forms (ages eleven to twelve) were given the *questionnaire* as suggestions and were asked to write an essay on handwork. From them we get the 'home' point of view, the views of the mother, father, sceptical brothers, and of the younger children, who appear to clamour for the toys.

"Handwork is my favourite lesson next to Botany. It is a delightful pastime for myself and a great amusement for my little brother when it is finished. 'Have you finished



PLATE II

A TOY-MAKING CLASS AT STREATHAM

the swing yet ? ' is the usual question which greets me every Thursday evening. When I am able to do handwork extra nicely I shall do a very nice piece of work and keep it as long as I can, and when I get old it will remind me of youth."

"My brother tries to make some of the things I bring home. My sister likes the swing and uses it for her dolls."

"It is a source of enjoyment to most children, but until I entered this school I had never heard of girls being taught it. I enjoy this so much that I hope to buy some tools and wood and do some work at home. My three brothers tease me terribly and call me the 'left-handed carpenter,' because I always work with my left hand. I am not satisfied with the handwork I have done at present, but hope greatly to improve. I enjoy making useful things because they make very useful presents at all times. I should like to teach handwork to others, as I think it so interesting. I have discovered that handwork needs patience and neatness in every way."

"I have learnt that everything must be done properly, because I made a motor-car and gave it to my little sister, but she happened to drop it and it came unstuck. My little brother thinks it's silly for girls to learn handwork, and everything I bring home he says, 'I should not have done it like that,' and goes on to explain how he would have done it, although he has never learnt himself. I don't like the part much where you have to prepare everything to put together. I like putting it together and then you can see something for your work."

Some show the ethical value of the training ; the need of patience seems to appeal most forcibly to children who are making their first attempts at handwork.

"To make toys and other wooden things teaches us to be patient, for often just at a critical moment something will come unstuck and we have to begin all over again. The top of the roundabout which I am now making has come off three or four times, and consequently it has taken me about twice as long to make as it would if all had gone smoothly."

- “Sometimes you have to wait for a piece of wood to stick. The other Friday I was waiting for a piece to stick and after a while I went on, thinking it had got stuck; unluckily it had not and it came off. That very same piece of wood has come off every day except to-day. This shows any one that one needs time and patience. Also you have to wait a while because some one has run off with the glue-pot, or else I find my file or gimlet disappeared.”
- “When I first began handwork I could not knock a nail in straight or else I would hit my fingers. But I can now knock a nail in straight and without knocking my fingers. I can saw much more quickly than when I first began.”
- “It teaches us a great lesson of patience. For instance, it is very trying to have to sit or stand for quite a long while holding some little refractory piece of wood that will not stick however much one tries: but it is no good getting cross, for the work will not be finished if we do not stick the little piece of wood or paper.”
- “Once mother told me I had not any idea for anything, but now she says I am much better, this being one result of handwork.”
- “Handwork, I think, has cured me of one fault and that is inaccuracy, for if the wood is not the proper length, it will not fit on to the thing which is being made. I have never done this kind of work before, but I think it does help us when we are grown up; one way is that everything must be accurate; and it is also very nice to make things.”
- “I find that handwork helps me greatly, as I am bad at my drawing and needlework.”
- “I love using the saws and hammers. Mother is going to give me a set of fretwork tools so that I can put fancy tops to my frames, etc. If I had a little sister or brother I would make a motor or train, but as I am the only one, I make things for ornaments. Next I shall make a table with the two sides to let down, or one with a separate leaf to put in. Handwork teaches you to be exact and to hold things delicately. It is very awkward to hammer a nail into a thin leg of a table or chair, because they wobble over.”
- “I think handwork is very interesting and it has taught me

patience. I am not allowed to read more than half an hour after I have done my homework and practice because my eyes are weak, and as I am what some people call a book-worm I used to miss reading a great deal, but now I do handwork in my spare time. One day I hope to complete my doll's house, its garage and furniture, but I have not finished the house yet. I like making such things as chairs and tables best of all. Handwork lessons were unknown to me until I came to this school nearly two terms ago, and at first Mamma was always telling me that she would not let me do any more at home, until I thought of putting paper on the floor, which keeps the shavings and sawdust from untidying the floor. I always do this now, and when the paper is taken up I do not have so much trouble as that of picking the pieces off the mat and then sweeping the floor before I go to bed."

"Handwork also helps to make one accurate and careful; perhaps your fingers 'were all thumbs,' as the saying goes, before you started handwork, but you find that after say a month your fingers would be able to touch a frail thing without breaking it."

Their desire to make and remake varies between 'pleasure toys' and useful articles; one suspects sometimes a desire to appease the vexation of the 'house-proud' mother when there is much disorder caused at home with shavings and sawdust.

"I can not only make toys, but useful things such as dish stands, brackets, photo frames, also easels to stand photographs on."

"I like handwork. For voluntary work I do handwork, and it is also our first lesson on Friday afternoon. I like it because it helps us to make useful things. For voluntary work I am making a medicine chest. It will be handy, because we always have a great deal of medicine at home. Last term I made a knife-box, and it was useful, because Mama's was getting old. My favourite tools at handwork are the saw and hammer. Next term I want to make a writing-case and a Red Cross motor."

"I enjoy going to handwork very much. The first thing to

think about, on getting down to the handwork-room, is setting to work, and going about everything quietly. Everything in handwork, to be done nicely, must be neat, clean, and carefully made and put together. In handwork I have made an easel (which is a bit difficult to fix, unless one has a proper hinge at the back) and a picture-frame and a little doll's house, and I would like to make another one, as I think it is so interesting planning out each little corner for different things, and it helps one to think of how they would plan out a home if they had one of their own, as perhaps some of us will. I am now making a tram-car, which is really very difficult. I have not nearly finished yet, as there is such a great deal of work in it."

"Girls' likings for tools differ, but a file is the nicest tool, in my eyes; it makes the rough places quite smooth and nice. In my experience of handwork I have made a boat with the captain's bridge and riggings, funnels, masts, and railings around the edge. I have also made a picture frame and doll's furniture for a friend's sister. At home I have made a basement for a doll gentleman's house for the servants to live in; I papered it and made it look neat and tidy."

"It is rather nice to see all of the girls making things at the tables as busy as bees and it is nice to see their faces when they look at the thing which they have just finished."

"The lesson I enjoy most during the week is the one termed handwork, really carpentering on a small scale. There are many things you can make, and if you take great pains with them they become really pretty little ornaments; in fact, I am thinking of having some shelves specially for my toys."

"When thinking of what measurements to make your toy and planning it out in figures I think that it helps you greatly in arithmetic. The hardest tool to use, I find, is the saw; you have to have a steady hand to use it. When I first took handwork lessons I used to think it hard work, but now I think otherwise, and feel rather grand when I show my parents the things I have made. The most important use of handwork is that when you are older you can knock a nail in or mend anything that needs mending in the wooden line, instead of having to wait until father, brother,

or husband comes home tired for them to do it. As well as this there might come a time when the making of toys would help to earn the daily bread."

"I am making a tram-car now, and when I have finished it I want to make a whole set of furniture for a doll's house. The hardest part of it will be when I am putting legs on tables or chairs. They have to be quite straight or the table will not stand up.

"Sometimes we have just settled a post or a rail in the right place with the help of some glue when somebody knocks the table and over goes our piece of wood. Then we have 'to grin and bear it.'"

"Our teacher's name is Miss Polkinghorne, she being very skilful and does much better work than us for we are only miniatures yet awhile!"

"When I grow up handwork will be useful to me, for if anything breaks I shall know how to mend it, and if I had children I could make things to amuse them. Often I do handwork at home. I like using the saw better than any other tool. I have made a good many things, but I think the best was a little toy motor-car. Handwork is my favourite lesson; when I grow up I shall never leave off doing handwork. My little sister helps me sometimes. I think she will like it. My mother has asked me to make a little thing to put match-boxes in."

"I think that it helps to make you very careful. For when one is hammering and the hammer slips you get hurt and that makes one careful. The hardest thing to do in a writing-case is to saw the piece of wood for the ink division. It is hard to get the exact size, but it does not look nice if it does not fit exactly."

"I like handwork because it is different from any other lesson in the week; there is not much writing to do, only to mark on the wood certain lengths."

"I once spent a long time in doing a ship, but I could not get on. I spent a very long time in trying to take the paper off a tobacco box, but it was not going to come. I then went on with the making, but it kept falling to pieces. I took it home, and took necessary materials with it; paper for flags

and nails. I was a long time in doing it, as I took everything apart and scratched all of the paper off; but it now looks very much better. Handwork is rather a funny kind of occupation for girls, but it teaches us how to do things."

"Handwork is one of the most interesting lessons that there is. It helps one to have ideas, and also to be careful. The reason why I like it is because I think that most people should have a pastime and this is a very pleasant one, and I think most children will agree to this point."

"I have to use many kinds of tools but the nicest is the hammer, because when I use it I know I am near the end of a piece of work. (It is not that I dislike handwork, but that I am going to start something fresh.) I have already made two picture-frames, two beds, a swing, a chair, a motor-car, an easel, and I am now making another swing. I think I shall try to make a baby's cot after I have finished my swing."

"I prefer to saw wood and stick pieces of wood together to hammering nails in the wood, because the nails are sometimes difficult to get in, for they very often go in crookedly. When we get older and understand handwork more thoroughly we may be able to make things for the home, such as knife-boxes and paper-racks; the things we make now are mostly pleasure toys that we will amuse our younger brothers and sisters with. In most cases it needs a great deal of patience, for the things, however simple, have some difficult part."

"I like making toys, so then if you make them nicely you can take them home for your little sisters and brothers to play with. Handwork gives you ideas about things. We can make very useful things such as letter-racks and pipe-racks. I like making furniture for dolls' houses—chairs, tables, and sofas. I like making swings. Some of us make animals."

"I do not know very much about handwork, as I have scarcely handled a tool before I came here this term, but I think I shall always enjoy it very much.

"I am making a doll's house now, for my little sister (aged five), and I think it is teaching me to make myself useful, because nobody at home cares for it much, so I will soon be able to mend chairs, make brackets, etc., etc.

- “ Since we have not been able to have proper firewood at home lately, mother has had large wooden boxes to chop (a thing I delight in doing), and now and again mother has given me a few of them. I tried to make things out of them and soon found it too rough : so father has given me some nice polished wood, and he says that perhaps soon he will buy me a nice little fret-saw set of tools as his are so large and clumsy.
- “ I think I like sawing best of all, but I think I like all the rest very well ; I get quite excited when Thursday and Friday come round (for those are the days on which we have hand-work).
- “ Mother thinks it is a splendid thing for girls, and I quite agree with her. And we both think that it will help me on with my geometry (which I’m not very brilliant in, but am trying my best).”

These compositions were written in school and the extracts have not been corrected, they are just as the children wrote them ; we add no commentary, but let them speak for themselves.

TOY-MAKING IN SCHOOL AND HOME

CHAPTER I

TOY-MAKING AND ITS EDUCATIONAL POSSIBILITIES

ONE'S main object in teaching children how to make toys should be "to teach them how to make toys." Through their efforts to make a beautiful toy they may become more patient, more accurate, more observant, and more nimble with their fingers, but these virtues will come more naturally and readily if the teacher has but one object in view; singleness of purpose is the secret of success.

Through classes in toy-making rightly conducted the children become more resourceful, more quick at finding the right thing for the right place, happier in some cases—that is to say, the so-called dull child, the child that has no gift for mathematics, no memory for languages, can often find in the handwork class the happiness of doing something well, of producing a praiseworthy and pleasure-giving piece of work.

It is very necessary to find occupation for backward children, who sometimes drift rather aimlessly through the school, occupation that will develop initiative and involve effort, occupation that will bring disappointments (so often one careless bit of work spoils an almost finished toy), but will also bring the joy of successful achievement.

The ordinary lessons—English, French, etc.—may be said also to bring their disappointments and joys, but not in the same tangible way as the handwork lesson. The table that will not stand steadily because all its legs have not been carefully cut the right length teaches to a certain type of

mind a more forcible lesson than the incorrect sum or French exercise.

Again, it is very necessary that one lesson period a week should be devoted to an occupation which is of the nature of a hobby ; the ordinary history and geography lessons do not often suggest voluntary work for the children's leisure. Indeed, in many cases it is easier to train children to become future clerks and teachers than to train them how to use their leisure. Now handwork classes suggest leisure occupations. The children who begin to make their own toys in the lower forms for themselves, when older will want to make them for other little children, when older, too, they will begin to ask how to make useful articles—writing-cases, medicine-chests, knife-boxes, soap-boxes—articles very frequently suggested by their parents and much valued by them when made.

One need scarcely fear for the future of the child, however dull and mechanical her daily work as a grown-up person may be, if she has abundant interests in life—if she can use and love to use in leisure moments hammer, saw, and file, or if she has some other healthy hobby. Still, for those who like the pleasant noise and pleasant mess caused by tools, it is hard to find a happier occupation than toy-making. A toy-maker becomes at once a collector of useful odds and ends, and a collector (that is, one who collects willingly the things he likes) is always a happy person ; the toy-maker becomes, too, the contriver, one who can adapt materials to different purposes, and the giver—for the finished article must be disposed of.

The mere acquisition of knowledge forms the least important part of school work. A large number of facts in connexion with history, geography, French, etc., have rightly to be learnt by heart and are useful to the child in after life, but they do not bring with them necessarily wisdom, nor does the learning of them play such an important part in the child's development as the activity of the child in the handwork class does. Some one has wisely said, " If education at school means nothing more to the children than a respectable routine and a few examinations successfully circumvented, then education is a failure ; *if besides that*, it has enlivened the years and counted for something in the general joy of growing, then it has a real value—a value which entitles it to a place among

happy memories, perhaps even the highest place of all." Many of us perhaps feel in looking back on our schooldays how many good things we lost for the sake of learning some now forgotten facts; how many good things we lost to be first in class; we confused means with ends, we toiled over our history and learnt it to get full marks in the coming test (we should have toiled over our toy for love of making it and to produce as perfect a one as possible); in after life we would gladly tread some of the by-paths of knowledge, have some hobby, but our rigorous system of training left us no opportunity in young days, and sapped the energy that alone would make it possible in after years.

No scheme of work then for schooldays must be so rigorous that it leaves no leisure for 'feast days.' Some days, some hours must come back to memory, bringing not only their past happiness, but ideas for present occupation. The happiest days of youth are generally the busiest, days when one had something one really wanted to be busy about for its own sake, not for the sake of marks or for the sake of outstripping one's fellow-pupils, or for the sake of one's future. These busy, happy, idle days are the feast days of youth, days one thinks of as the poet thought when he wrote:

And none will know the gleam there used to be
About the feast days freshly kept by me,
But men will call the golden hour of bliss
'About this time,' or 'shortly after this.'

This book on toy-making is not written to advocate the so-called 'primrose path in education,' the 'turn-work-into-play theory,' though undoubtedly the first chapters at least of this book will be attacked by those who fear that education is yielding or is going to yield to a popular clamour for ease.

For these people, too, Masfield has a message:

Best trust the happy moments. What they gave
Makes man less fearful of the certain grave,
And gives his work compassion and new eyes;
The days that make us happy make us wise.

Moreover, every teacher of handwork knows how little ease the busy children in her classes get—in these classes they are never passive listeners or passive learners by heart. They see the need

of accuracy, the labour necessary to produce it, they suffer for every mistake they make, they realize some of the joy and pain of creating, and, best of all perhaps, they realize the joy of work—active, muscular work as distinguished from their ordinary scholarly work.

With regard to the question of work it has been ably said that “No one has yet preached in an adequate way the gospel of work—real hard work—as the most amusing of all occupations—not a noble duty.”

It is somewhat unfortunate that directly one begins to like one's work one is accused of playing.

To return to toy-making (which is work or play, according to whether one dislikes or likes it)—whether toy-making be taken in the school or not, the teachers will find it a useful hobby. Through it they can amuse themselves and renew their youth; through it they will have an enduring bond of union with their children.

Our knowledge of history and geography often fails to impress our children; they probably think we are a little foolish to burden our heads with so many facts that seem to have no bearing on to-day; but when we can use our hands and make a toy they see us with other eyes, we are really clever people worth cultivating.

If toy-making be taken as a form of handwork in school, one enlists at once the interest of the parent—especially of the father—the mother sometimes, not often, objects to the mess. This interest of the parents is a great gain; the father delights in doing a bit of the work—sticking on the difficult funnel, sawing the hard piece of wood; child learns from parent, and parent from child, and in this way the father may again remember half-forgotten ambitions, half-neglected talents, and find in toy-making a profitable occupation, profitable mainly in the fact that any occupation which recalls to the grown-up person his youth, with its fresher outlook on life, must be wholesome.

Finally, if the handwork classes make the children more ‘at home’ with themselves and with life, they will have done something; if they help them toward self-realization they will help them toward the joy the writer speaks of who says, “Joy of life seems to me to arise from a sense of being where one belongs, as I feel right here; of being four-square with the life we have chosen.

All the discontented people I know are trying sedulously to be something they are not, to do something they cannot do. . . . It is curious, is it not, with what skill we will adapt our sandy land to potatoes and grow our beans with clay, and with how little wisdom we farm the soil of our own natures ? ”

CHAPTER II

GENERAL PRINCIPLES; MATERIALS

IN toy-making in schools it is very necessary to design toys that can be made from materials which are easily obtained. The Board of Education in a report on handwork in the London elementary schools says: "The range of materials used is limited, as a rule, to paper, cardboard, clay, and 'prepared wood' or 'stripwood.' It is perhaps unfortunate that these are almost entirely 'school materials,' in other words materials which are not likely to be much used outside the school, either in the child's home or in after life."

There is truth in this—to give the child too much 'prepared material' tends to make him less inventive, resourceful, and painstaking, and prevents him from continuing his work at home, where he has not got prepared material. Any series of toys made from the same material—say a series of toys made from match stales or from 'stripwood'—has very limited educational advantages. Toys made from a combination of waste materials are the best—match-boxes, cardboard and wooden boxes of all sizes, mantle-boxes, reels, corks, broom-handles, silver paper, etc., can all play a part in producing an effective, even a beautiful toy. Most of the toys described in this book are made from so-called 'waste materials.'

With regard to infant school work, squares of white paper—cartridge paper or ordinary exercise paper—which the children can colour themselves are better than a too slavish use of the coloured gummed squares supplied to schools. Further directions with regard to materials will be given in connexion with the various toys. It is advisable to use as few tools as possible, both because the fewer tools the less expense and because the fewer tools the more thought and ingenuity required. To have a perfect instrument at hand for every need paralyses work, thought, and happiness. Most of the toys in this book are made—if for

little ones, with scissors, if for older ones, with hammer, saw, and file.

A graduated course is necessary. Generally speaking, the little ones from five to seven make their toys of paper, clay, plasticine, and raffia. Children from seven to ten can make simple wooden toys. Wooden toys are the best ; many things can be done with wood, impossible with cardboard or paper, and they are so lasting.

Cardboard modelling is always difficult, and as a rule should not be attempted by children younger than nine. Except that they provide practice in accurate measurement, toys made of paper and cardboard by children of nine or older are disappointing, they crush so quickly. Quite strong toys can, however, be made from a combination of wood, cardboard, and paper.

If really strong paper toys are required (for example, the various articles of doll's furniture, the table and chair, etc., are more valuable if strongly made), an excellent medium can be made by pasting (using ordinary flour paste) two or three sheets of paper together and allowing them to dry thoroughly under pressure. Both or all three sheets must be pasted over before they are brought together to avoid subsequent curling. This will, however, prove too stiff a medium for children younger than five.

Skewers will be found very useful in toy-making. Any ordinary metal skewer is useful for boring holes in cardboard and corks, while the short meat skewers, three inches long (cost twopence per dozen), are an excellent substitute for bradawls when the children are making the early light woodwork models ; later on in woodwork a fine workman's bradawl is required, or a drill.

Wooden skewers are useful for axles of all kinds.

Another useful boring tool (for making holes in paper, corks, or cardboard) is the metal pin stopper supplied with tubes of seccotine. This bores a hole in cardboard or paper that is the right size for a match. When boring holes in cardboard the children will find a cotton reel useful to bore upon ; their meat skewer or seccotine pin stopper can then pass through the cardboard into the hole in the reel.

Methods of joining Cardboard and Paper Edges. (1) Leaving a flange. In Fig. 1 the shaded portions represent flanges—flange A is for joining side of house B to C, flanges D, E, F, G

are for holding the roof; they must, of course, be bent at right angles to the sides B and H. (Note flange in socket of candlestick, Fig. 49, Chapter IV, and in pigeon-house, Chapter X.)

If Fig. 1 is made of cardboard, flange A must have the surface

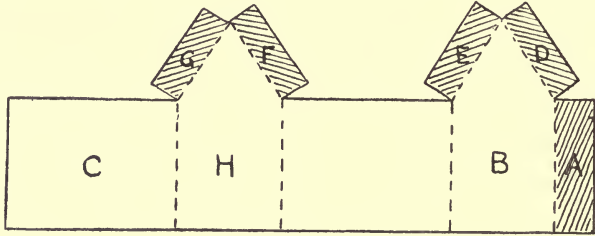

FIG. 1

of the cardboard pared away, otherwise the joining will be clumsy. The dotted lines represent bends only in the case of paper, but half cuts in the case of cardboard.

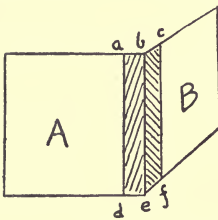

FIG. 2

With regard to the size of the flange, this will depend upon the strength of the adhesive used and the stiffness of the material. Generally speaking, the larger the flange the better, for a narrow flange tends to turn up and must be held down longer than a wide one.

A good general rule to remember when joining two pieces of material is this—that it is always the thinner of the two that is to be pasted or glued. This must be borne in mind when using the second method of joining cardboard or paper edges.

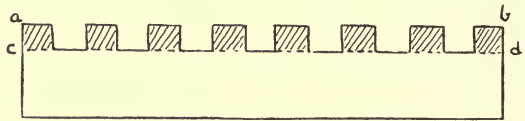

FIG. 3a

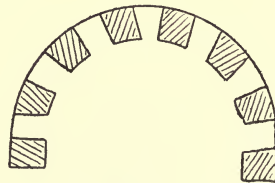

FIG. 3b

(2) Using paper hinges. The hinge should extend the whole length of the edges that come together, as in Fig. 2,

where pieces of cardboard A and B are joined by the hinge *a b c d e f*. Before pasting the hinge must be folded along *b e*, care being taken that *b e* is at right angles to *a c* and *d f*.

The sides, bottom, and roof of the Noah's Ark are joined together by paper hinges (Chapter X).

(3) Wherever it is necessary to join curved edges, the flange must be cut as in Fig. 3*a*, flange *a b c d*. Fig. 3*b* shows paper curved and flanges bent down ready for pasting.

This is the method used for fastening on paper funnels, the bottom of the paper mug (Fig. 57, Chapter IV), etc.

The Making and Fixing of Wheels. If it is desired to attach movable wheels to any of the toys described in the following chapters (in the early chapters for greater simplicity the wheels are gummed to sides of carts, or to matches, etc.), the following methods are suggested.

(1) The wheels can be rigidly fixed to the axle—that is, a match end is pushed tight into the cardboard wheel and the axle is free to turn in loose bearings, as in Fig. 4, fixed under the cart or other vehicle or to the sides. These bearings can be cut from cardboard or cartridge paper.

In Fig. 4 the paper is bent at a right angle along the dotted line, and the rectangular portion is gummed under the cart. If the rectangular portion is gummed to the side of the cart no bend is needed. The parts of the match sticks that pass through the holes must be rounded with sand-paper so that they will turn easily in the holes.

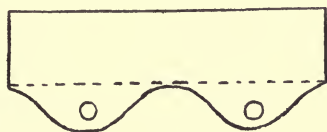

FIG. 4

(2) The axle can be glued to the bottom of the cart and the wheels left free to revolve. The wheels are kept in their places by the following plan. Cut some small cardboard washers, seccotine one near each end of the axle as in Fig. 5*a*, taking care that they do not come under the cart. Slip on the wheels, taking care that the centre hole is punched large enough to allow the wheel to revolve freely. This will be the case if a steel meat skewer (size about 7 inches long) has been used to make the holes. Fix washers outside the wheels to keep them on, as in Fig. 5*b*. These washers keep the wheels from sagging.

These wheels will revolve if the match stick has been rounded with sand-paper.

With regard to the arrangement of the toys in this book, roughly they are described in order of difficulty, but for convenience sometimes this order has been departed from. For example, match-box toys have been grouped together, cork animals, etc. The teacher must select her own models from different parts of the book and use them in accordance with her children's ability and her own taste.

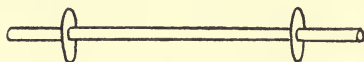

FIG. 5a

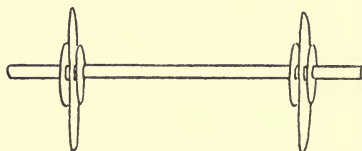

FIG. 5b

Another important principle to follow is this. The teacher should give as few directions as possible, be as silent as it is possible for a teacher to be. The child has an excellent opportunity in these classes of learning from his own mistakes. This opportunity must not be taken from him; he must be given the chance of finding out his own mistakes. Moreover, every difficulty should not be anticipated for the child; nor should too many warnings be given. Let the children set to work as soon as possible and use their tools without too many instructions about them. Let them ask, let them have the pleasure of discovering; every child wants to learn, but not every child wants to be taught.

All models should be made as large as is reasonably possible; this should be insisted on from the beginning. Lastly, great accuracy (though much to be desired) must not be expected from the child; careful work must be insisted on, but one must learn to recognize the careful work of a child (which is so different from that of the grown-up person) and not heedlessly blame him or her for not reaching perfection.

Accuracy is so often the outcome of 'lack of vision.' The child so often has that 'vision,' that imaginative outlook on life that floods the mind with ideas, but lacks accurate power of expression, while the grown-up person has the accurate power of expression, but has lost the fresh imagination of youth and all its ideals. We must see to it that we do not dim our children's vision.

CHAPTER III

PAPER WORK FOR INFANTS

Materials. White paper of any kind that is not too thick and bends easily, *e.g.* cartridge paper, plain white foolscap, pages from exercise books. Pieces of coloured paper are introduced into some of the toys. It is better, however, to encourage the children to colour the white paper with chalks. One must remember, however, children's delight in coloured paper and let them have it sometimes. A wall-paper sample book will provide coloured paper, and gummed coloured squares are supplied to most schools. These gummed squares are really too thin for effective toy-making, and there is the temptation to the child to lick them when making models from them.

Adhesives. In many cases the toys can be fastened together by means of paper-fasteners. Where this is not possible the following adhesives are recommended. (1) Gloy—this is clean and fastens the paper fairly securely. (2) Higgins' Vegetable Glue. This has one great advantage over Gloy: it cannot be spilt. A little of it can be put on a piece of paper for each child; this is a great convenience in a large class. (3) Home-made paste of flour and water; this is very clean and wholesome.

PAPER TOYS FROM THE SQUARE

The following toys should be made as *large* as possible, never from a square of less than 4 inches each side. The larger the toy the thicker the paper that can be used and the stronger it is. In the following diagrams, lines to be cut are drawn, lines to be folded are dotted, parts to be cut off are shaded.

As soon as possible the child should be shown how to make a large brown paper envelope to keep his work in.

Model 1. The Rabbit Hutch. Fold paper into 16 squares as in Fig. 6. Cut lines indicated. Draw bars in square A, or fold

along r s (Fig. 7) and cut out the bars ; the door is drawn and cut in

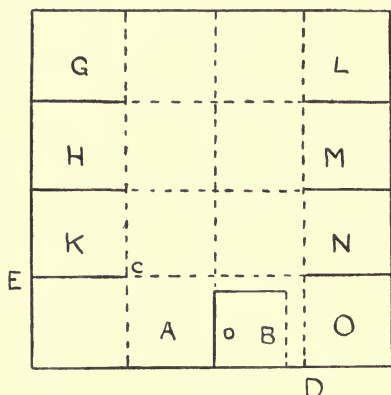

FIG. 6

(Fig. 8). Windows and panels are drawn on the paper. A roll of paper is put on top for the light, or a small piece of cork can be used. The wheels are drawn by means of halfpennies, then folded in half ; one half is pasted under the carriage, the other appears as in Fig. 8. Three or four carriages can be made and fastened by strips of paper.

Children delight in chalking the blinds of their carriages in various colours and labelling them 1st, 2nd, or 3rd Class. The top of the carriage should be darkened with pencil or chalk, or a piece of black paper pasted over it.

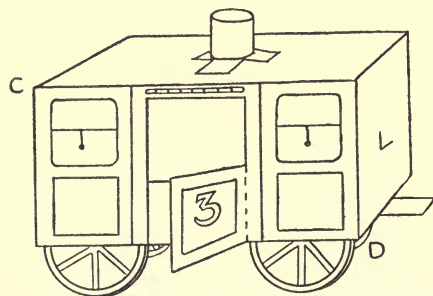

FIG. 8

E F (Fig. 6) and gumming L over N and M over L.

The **Basket** (Fig. 10) is a simple model. One quarter of the

square B. Colour the whole yellow or brown to represent wood. Gum L over M ; N over M ; o over N. The same on the other side. A small paperfastener makes a good handle. Rabbits and carrots can be cut out of paper to furnish the hutch (Fig. 7).

From a similar square folded into sixteen squares a **Railway Carriage** can be made. In this case the door is cut in the middle of c D

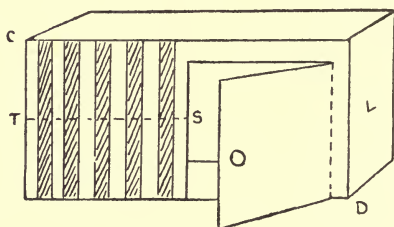

FIG. 7

A **Luggage Van or Cattle Truck** (Fig. 9) can be made from a square of the same size by cutting off oblong

square is cut off to form a handle. Cut remaining portion as in

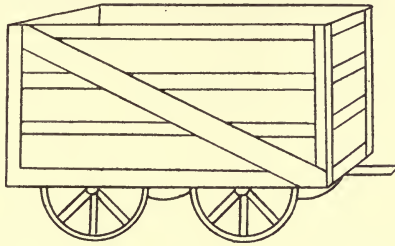

FIG. 9

Fig. 11, double over corners *a, b, c, d*, paste corner *d* over *D*, *c* over *C*, *b* over *B*, *a* over *A*.

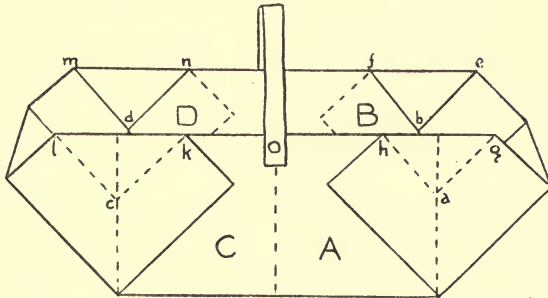

FIG. 10

The basket should be coloured with yellow chalk to represent straw ; the handle is fastened on with paper-fasteners.

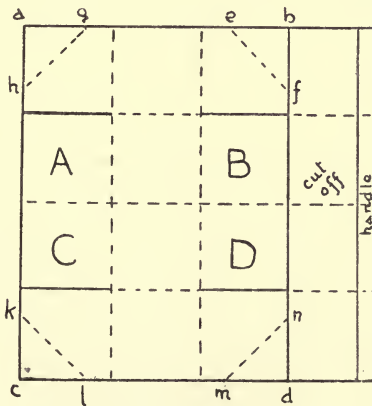

FIG. 11

34 TOY-MAKING IN SCHOOL AND HOME

Paper fruit, apples and oranges, can be cut out to go in the basket.

A Wardrobe. Fold square into sixteen parts and cut as in Fig. 12. Gum A over C and B over A. Repeat with D E F.

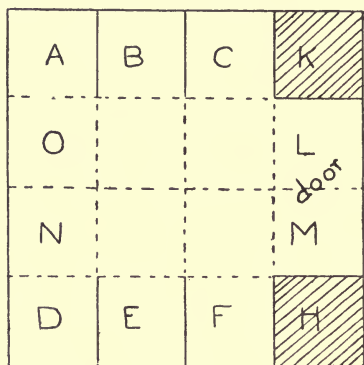

FIG. 12

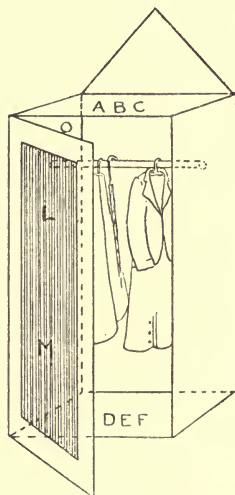

FIG. 13

Gum a piece of silver paper on the door for a mirror; square H, with its corners cut off, forms ornament on top (Fig. 13). A match is gummed inside, on which clothes are hung. The children can either draw these and cut them out, or cut them out from old fashion plates.

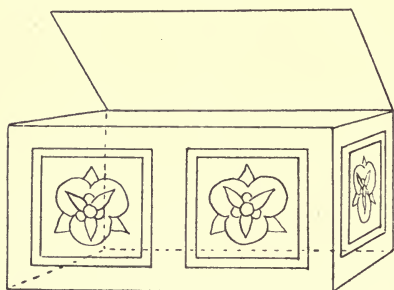

FIG. 14

By cutting off the lid and making a handle from it a basket can be made. The children themselves may be able to suggest some of these articles and should be encouraged to.

A Sedan Chair can be made in the same way as the wardrobe

(see Fig. 12). Loops of paper are gummed on at A and B (Fig. 15), through which the shafts pass; a window can be cut by folding the door C D G H in half along K L. A piece of coloured paper can be gummed inside the window for a blind; some sort of ornament

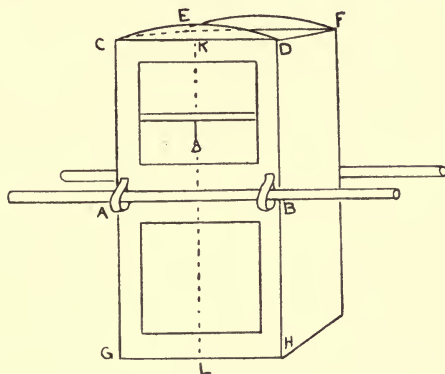

FIG. 15

can be gummed at the top along C D and E F. Panels, etc., can be drawn.

A Market Basket (Fig. 16). Fold square as for wardrobe (Fig. 12), cut off the quarter K L M H. Gum A to B and C to A—the same with D E F. To make lids, halve the quarter K L M H. Gum K to A (outside) and L forms one lid; gum H to D and M forms

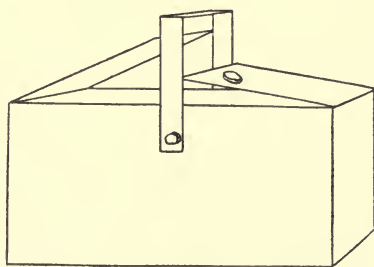

FIG. 16

the other lid. Paper-fasteners may be put in each lid for handles. The handle of basket must be made from another strip of paper. The basket should be suitably coloured before being gummed together.

A Cradle (Fig. 17). Begin with a square (each side four times the diameter of a penny). Fold and gum together as for basket.

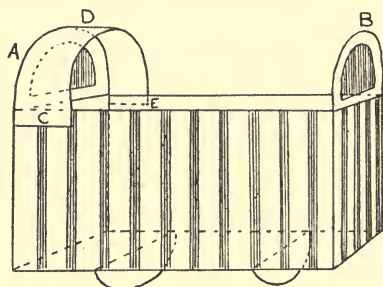

FIG. 17

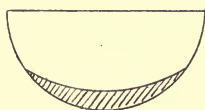

FIG. 18

Cut two round discs of stiff paper the size of a penny. Fold these in half. Gum one half of each disc on to bottom of cradle; the other half forms the rocker. These halves must be made less round by being cut as in Fig. 18, so that the cradle will rock. By means of the penny portions A and B can be cut to form top and bottom of cradle, a strip of paper C D E can be gummed across one end (round A) to form a hood (Fig. 17).

A Settee. Fold a square as for wardrobe (Fig. 12), cut off one quarter, K L M H. Gum A to B, D to E for arms. Cut arms as in Fig. 20. For back legs of settee use portion K L M H; gum K to F and H to C (Fig. 19). To strengthen the settee gum a piece of paper over N O and M L. Coloured paper can be pasted on back, sides

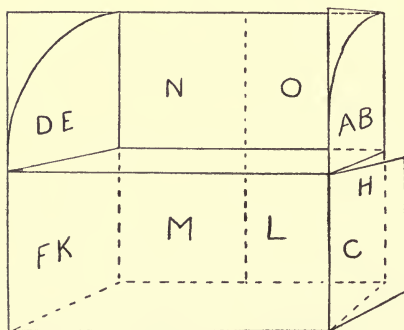

FIG. 19

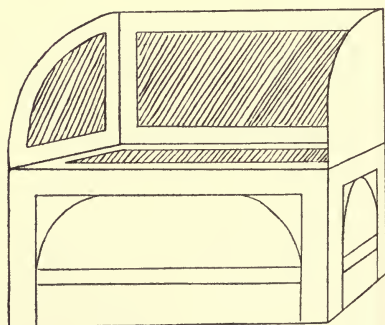

FIG. 20

and seat as shown in drawing. The legs may either be cut out or simply drawn on the paper as in illustration (Fig. 20). The settee will prove a really strong piece of doll's furniture. The

children should be allowed to furnish a doll's house with the various articles described in this book. When they have had some practice in making them each child can be allowed to make one piece of furniture for a school doll's house.

Table. Top of table is a square of white cartridge paper. Make the legs from a double square, each square the same size as

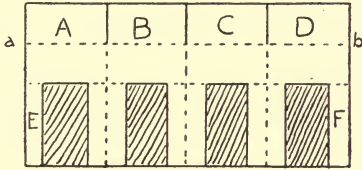

FIG. 21

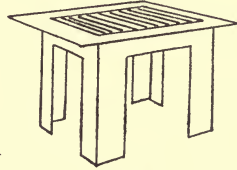

FIG. 22

top of table. Fold and cut the double square as in Fig. 21. Bend flaps A B C D carefully along *a b*. Gum A to B, C to B, D to A to form legs. Gum square top on to A B C D. A square of coloured paper can be gummed on to top of table as in drawing (Fig. 22). Leg E can be gummed to F by means of a paper hinge, or a flange may be provided, as in Fig. 1.

To make a Chair to go with the table. Take a double square the same size as that used for legs of table. Fold into eight as in

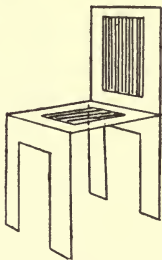

FIG. 23

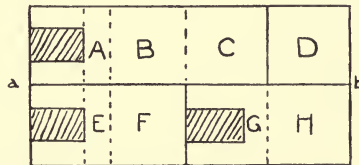

FIG. 24

Fig. 24. Cut in half along *a b*. Squares A, B, c form front legs, seat and back of chair respectively. Square F is gummed to B, so that E forms back legs. The chair must be strengthened by gumming H to c and G to E. Coloured squares can be gummed to seat and back; the rest of the chair can be chalked to represent wood (Fig. 23). A dining-room suite may be made in this way.

Side-board. Begin with two equal squares. Cut and fasten one square together as for rabbit hutch (Fig. 6), but cut two doors. One quarter of the second square must be cut and gummed on to back to form a mirrored top (Fig. 25). A piece of silver paper may

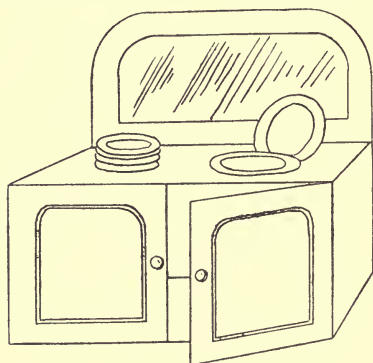

FIG. 25

be gummed on to back for a mirror. From the rest of the second square plates and dishes can be cut and coloured to go on top and inside sideboard.

An Arm-chair. Begin with square folded into sixteen parts (Fig. 26), cut off one quarter D H N S, again cut off one quarter

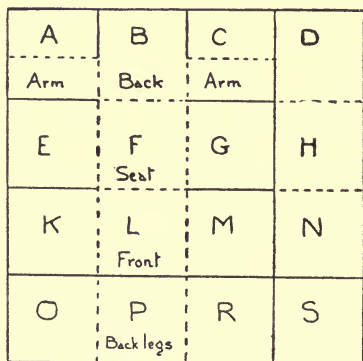

FIG. 26

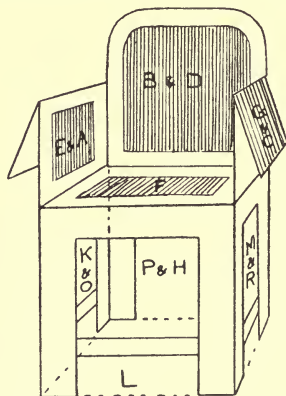

FIG. 27

O P R. Cut remaining square as in diagram. Gum E to A and G to C. Cut these squares to form arms. Gum O to K and R to M

to form back legs and sides. To strengthen chair cut off N from D H. Gum H to P and D to B. The corners of B are rounded. Coloured paper can be pasted over the arms and in the middle of back, seat and sides (Fig. 27). Legs can be chalked on P, L, K and M, or cut out as shown in the figure. If preferred the arms are not folded over but cut round. This arm-chair is a strong one and will hold a heavy doll.

A Bed. Fold a double square as in Fig. 28. Cut portions indicated. Gum A B C D to E F G H, the same the other side.

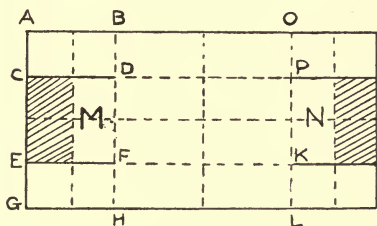

FIG. 28

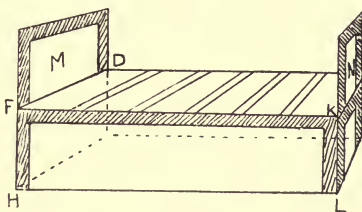

FIG. 29

Bend up M and N to form head and foot of bed. These can be cut any shape, or simply be coloured to represent beams. Legs can be drawn on or cut out of sides F H K L and B O D P (Fig. 29).

A Coal Scuttle. Begin with a 4-inch square, fold into sixteen

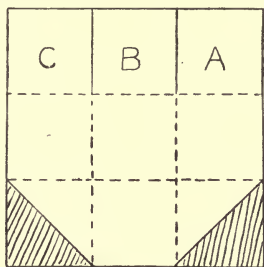

FIG. 30

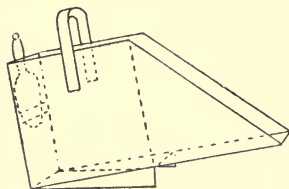

FIG. 31

parts, cut off a quarter, cut off a quarter again; cut remaining portion as in Fig. 30. Gum A over B, c over B.

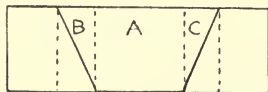

FIG. 32

For the stand take the smallest quarter (Fig. 32), fold and cut as in diagram. Gum A to bottom of coal scuttle. B and c form the supports; a handle can be cut and gummed on as in Fig. 31.

40 TOY-MAKING IN SCHOOL AND HOME

The children can cut a shovel out of paper to slip in a little paper band at the back (Fig. 31). The coal scuttle should be coloured black, with yellow to represent brass.

A Drawing-room Cabinet. Fold and cut square as in Fig. 33. Gum B over A, C over D. Bend E and K down and cut corners off

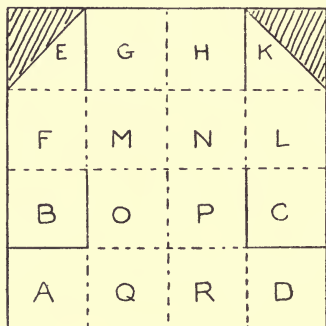

FIG. 33

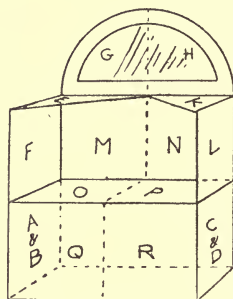

FIG. 34

to form shelves as in Fig. 34. G H can be cut round, or in any way to make suitable top for cabinet. Silver paper can be pasted on where desired for mirrors, doors cut or drawn, etc. From Fig. 33

the children will be able to make a number of simple and effective articles of doll's furniture—namely, doll's dresser, oak settee for hall, dressing-table, wash-stand, writing-case. These the children must be allowed to suggest and think out themselves.

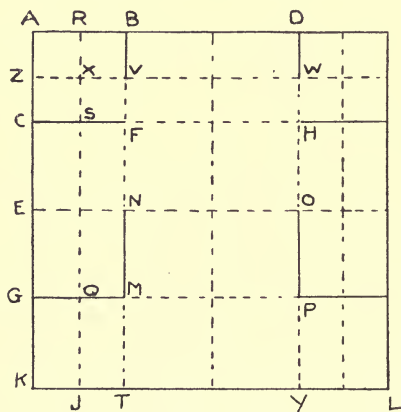

FIG. 35

the other side. Bend back c s G Q along s q to form side (Fig. 36); the same the other side. Fold B F D H along F H for roof, fold B V D W down as in Fig. 36; this portion should have name of shop written on it. Fold A B F C

A Shop or Stall. This will hold together without the use of gum. Fold and cut as in Fig. 35. Fold together so that square E N G M covers square G M K T; the same

along RS , so that AC coincides with BF . Fold down $RBXV$ so that top of $CSGQ$ lies between $RBXV$ and $ARXZ$; the same the other side; this folding keeps the shop together. Gum can be used if greater strength is desired. From paper the children

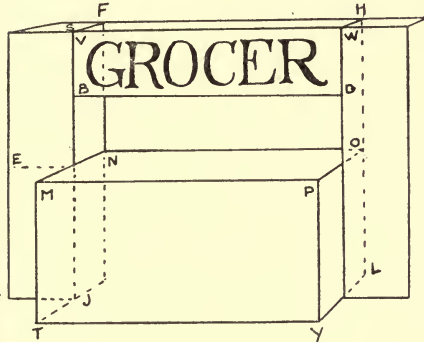

FIG. 36

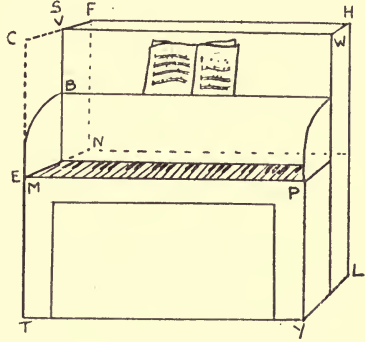

FIG. 37

can cut materials to furnish their stall. From a similar square a piano can be made as in Fig. 37. A piece of paper must be gummed to $v B W D$ to close up the hollow; the sides $s c G Q$ must not be bent back but cut as in Fig. 37 to represent the sides of a piano.

Some Simple Tents. A good imitation of an "A" tent can

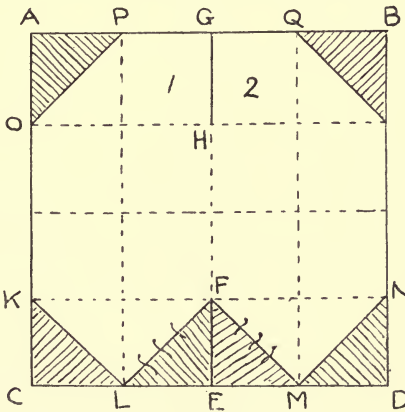

FIG. 38

be made by little ones from a square. Several of these make an excellent encampment for toy soldiers. Fold and cut square

42 TOY-MAKING IN SCHOOL AND HOME

as in Fig. 38. To fasten it together paste square 1 to square 2; this forms the back of the tent; edges P O, K L, etc., rest along the ground. Corners L and M must be bent back to form

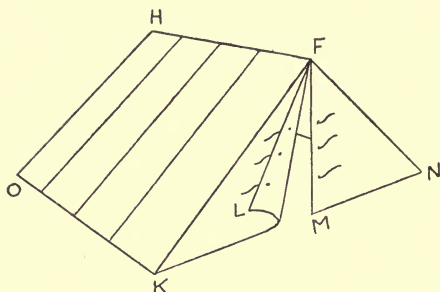

FIG. 39

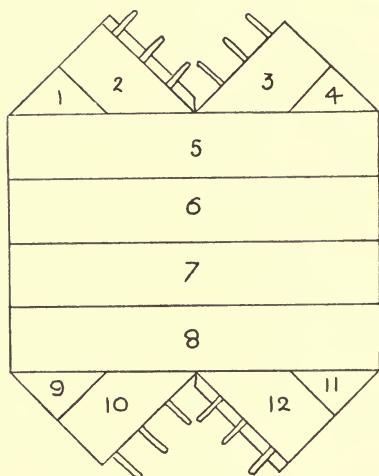

FIG. 40

the entrance. Pieces of cotton are fastened along F M and F L for straps for lacing up the entrance (see Fig. 39).

Fig. 40 shows a drawing of a real "A" tent spread out flat upon the ground. It is made of strips of canvas, 1, 2, 3, 4, 5, 6, 7, 8, 9, 10, 11, 12 sewn together. Children can imitate this in paper.

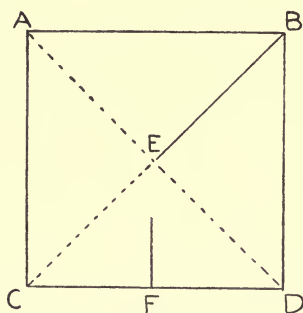

FIG. 41

A Triangular Tent. This is very simple. Fold and cut as in Fig. 41. Paste A E B over E B D. Cut door at F.

CHAPTER IV

MORE PAPER TOYS

A Bridge (Fig. 42). Begin with square (8 inches each side),

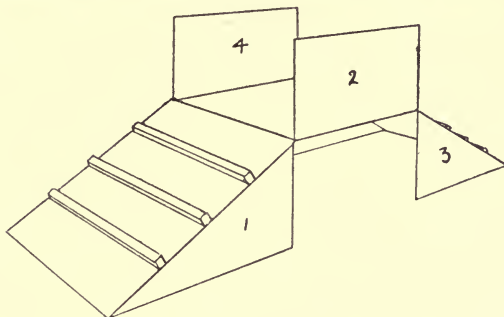

FIG. 42

fold in four and cut off one piece. Fold again in four, folds running in opposite directions to first folds, and cut off one piece.

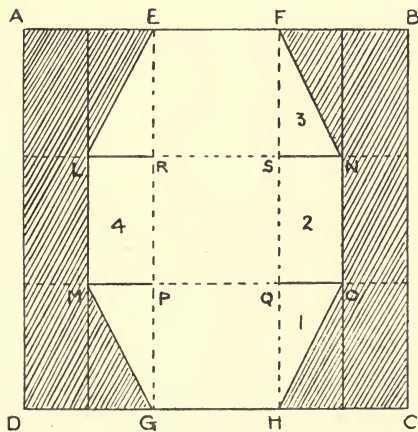

FIG. 43

A square, $ABCD$, remains, divided into nine squares (Fig. 43).

Fold AG and FC in halves, cut off shaded portions. Join LE , FN , MG and HO , and cut off shaded portions. Cut along LR , NS , MP and OQ ; bend as in Fig. 42. Matches can be gummed on the slopes of the bridge. If a piece of white cardboard or paper is placed underneath a river can be marked on it and paper boats made.

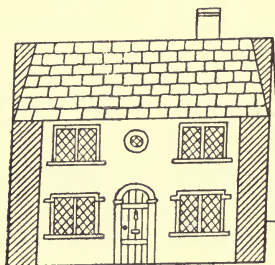

FIG. 44

a little flap of paper left at the end of the trunk of the tree. The house can be cut out of a piece of folded paper (Fig. 44) so that it will stand; animals can be cut in a similar way (Fig. 45). Boats are made of plasticine, with paper sails stuck in it. Children can add other animals and think of other additions to the scene.



FIG. 45

A Punt (Fig. 46). Begin with a square, fold into sixteen parts, cut off a quarter. Fold in half oblongs AB and CD (Fig. 47). Cut off the shaded portions. Cut along the lines ME , CN , OB , PG . Fold

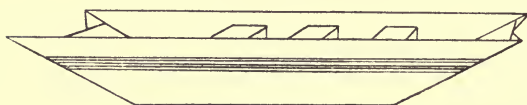

FIG. 46

along MK , FN , OL and PH . The child will accomplish this fold more easily if she puts her ruler along a line from K to M and folds the paper over it. A coloured band should be chalked round the punt. To fasten it together gum KEM to $MECN$, CNF to $MECN$ and so on the other side. Three seats are fastened inside, made from the quarter cut off the original square. The length of the seat is equal to the distance EC ; the height of the seat to half of the distance KE (Fig. 48).

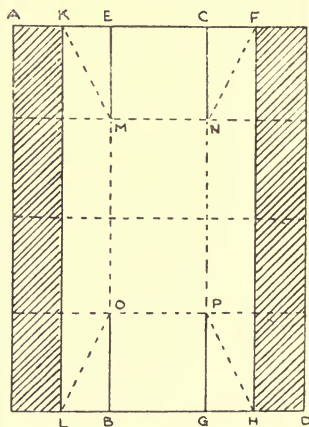

FIG. 47

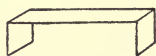

FIG. 48

along MK , FN , OL and PH . The child will accomplish this fold more easily if she puts her ruler along a line from K to M and folds the paper over it. A coloured band should be chalked round the punt. To fasten it together gum KEM to $MECN$, CNF to $MECN$ and so on the other side. Three seats are fastened inside, made from the quarter cut off the original square. The length of the seat is equal to the distance EC ; the height of the seat to half of the distance KE (Fig. 48).

The punt should be made from a square of cartridge paper, eleven inches each side. It will be found to float well on water.

A Candlestick (Fig. 49). Begin with two squares of coloured paper (sides 4 inches); one forms the bottom of the candlestick; half the other forms the candlestick; half the other forms the socket. To make the socket fold and cut as in Fig. 50. The other half divided lengthways forms the handle. The handle and socket can be fastened on with paper-fasteners or gummed. It looks neater when gummed. A roll of yellow paper or white paper coloured forms the candle; into this roll some cotton-wool

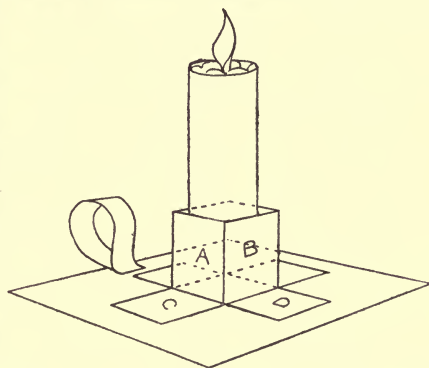

FIG. 49

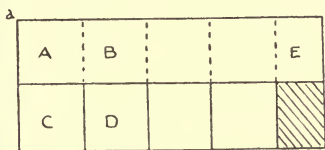

FIG. 50

is put and into this a piece of red paper for the flame. Children delight in making candlesticks of different colours and decorating their form rooms with them. The candlestick can be strengthened by being gummed on to a piece of cardboard

(a post-card will do). A round candlestick can be made in a similar way.

To make the socket, fold the oblong (Fig. 50) into four parts, leaving a piece, E, over; gum E to A.

A Lantern. Begin with an oblong 8 inches by $5\frac{1}{2}$ inches, A B C D (Fig. 51). Fold along E T K and G H to get flanges. Fold C A B D into half to obtain the line L M, and fold A L M B into four parts to obtain the line L' M'. Fold A H C G into four parts along Q P, O N and S R. Draw the top of the lantern in A H L' M', as in Fig. 51, and cut off the shaded portion. Draw or cut windows in the sides of the lantern. Cut the flange abc as in the diagram. Make the candle and the candlestick to fit into the lantern as in Fig. 49. (Note the length of the edge of the candlestick is the width of the lantern E T.) Bend the flanges a, b, c at right angles to the sides and gum the candlestick to these.

Flange *d* can be gummed to the edge *L'E*, and a door cut in one of the sides, or flange *d* can be cut off and then side *l* forms the door. Make holes in the tops of the lantern and tie together with

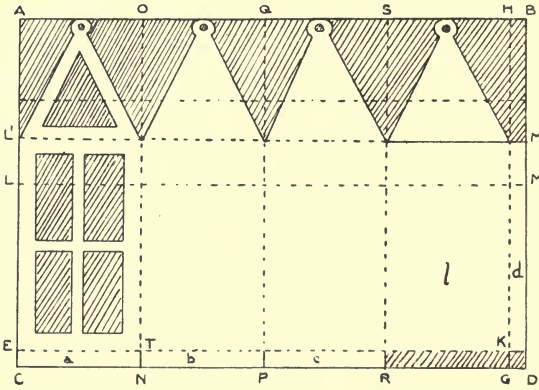

FIG. 51

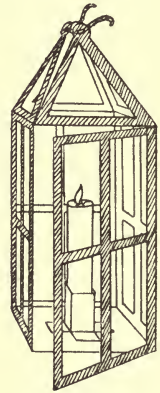

FIG. 52

thread, as in Fig. 52, or the flanges can be left round the triangular tops and they can be gummed together. Fig. 52 shows the finished model.

Colouring the Lantern. The lantern can be made of black paper (lines must be drawn on the white side), or white paper chalked, or painted black or yellow, etc., according to taste.

A Well and Bucket. The well is made from an oblong about

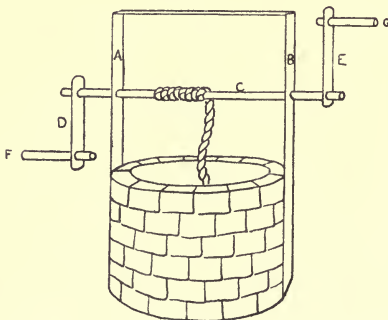

FIG. 53

$2\frac{1}{2}$ inches by 10 inches. Fold down one side of the oblong, about $\frac{1}{2}$ inch; make cuts along this fold as in Fig. 54. When the paper is bent round to form the well, these cut pieces form the edge of the well (Fig. 53). *A B* is a piece of cardboard or stiff paper bent, as shown in the diagram, and gummed to the sides of the well. Two holes must first be made in *A*

and *B*. Then through these holes a piece of cane *c* is passed. *D* and *E* are pieces of cardboard of equal size; holes are made

in each end and the strips are glued to each end of the piece

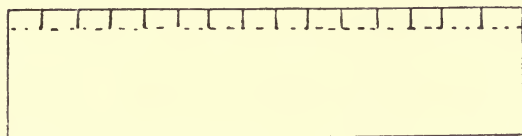

FIG. 54



FIG. 55

of cane. Into the other holes are glued two smaller pieces of cane or two matches, F and G, for handles. The well should be coloured red before being fastened together.

The bucket (Fig. 55) is made from a small oblong. Fold and cut off the shaded parts as in Fig. 56.

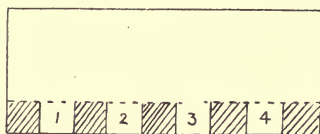

FIG. 56

When the bucket is fastened together stand on a piece of paper and draw round it to get the measurement for a circular disc for the bottom. Cut this out and gum it to the bent edges 1, 2, 3, 4. A handle can be made of string or paper.

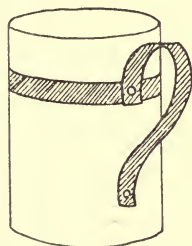

FIG. 57

A Mug (Fig. 57). This is made like the bucket. The handle is made of a strip of paper fastened to the mug by paper-clips. A band of coloured paper is gummed round the mug; the handle can be made of the same coloured paper as the band.

Motor-car. Begin with a square (8-inch side). Halve it. Fold each half into thirty-two parts.

Cut one half as in diagram 58. Gum A to B and D to C, E to F and H to G. This forms the body of the car. The doors must be cut in squares K, M, L, N. From the second half (folded into thirty-two) pieces can be cut to cover exactly the front of the car, and to form seats O and R and backs and sides, S T.



FIG. 58

59 The wheels are drawn on stiff

paper or cardboard by means of halfpennies, cut out and gummed

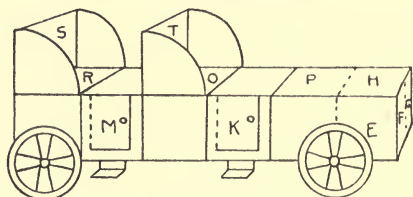

FIG. 59

on to the sides. The children of six who made this car enjoyed adding, according to their own ideas, steps, steering-wheel, and other details. The car looks more attractive if coloured and if the seats are covered with red paper.

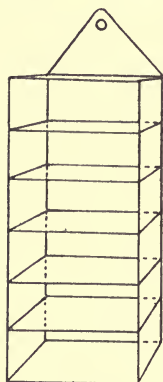

FIG. 60

From a similar square (8-inch side), divided into two (each half divided into thirty-two parts), a Book-case can be made (see Fig. 60). One half gummed together as for the motor forms the case; the other half forms the shelves and the ornament on top. A door can easily be added, or two doors, one on each side.

A Wigwam. Begin with half a square (Fig. 61). Fold into thirty-two parts. Draw a curved line from A through B and C to D, and from A through E and F to G. Cut along these lines. Join K with H by a curved line and H with L. Cut along this line. Gum L N to K M. Fold back the corners G and D for the door.

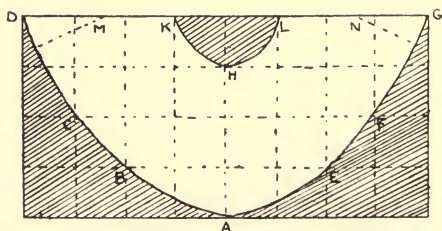

FIG. 61

Strips of paper can be cut out and gummed inside the wigwam for poles. Designs can be drawn on wigwam as in Fig. 62. Marks

from κ to m show where it is laced up. The wigwam should be coloured brown, the circles on it red and white or yellow. This model will be found useful when illustrating scenes from *Hiawatha*.



FIG. 62

Other simple models to go with this are—a bow, arrows, quiver, canoe. The bow can be made from a piece of cane, the arrows cut out of paper.

A Quiver. Fold square into sixteen parts (Fig. 63). Join A

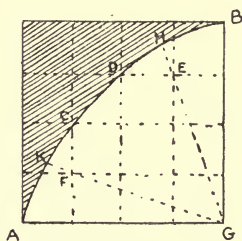

FIG. 63



FIG. 64

to c , c to D , D to B by curved line; cut along it. Join E with G and bend along it; G with F and bend along it. Gum $B H G$ to $A K G$. Fasten a piece of string as in the drawing (Fig. 64).

50 TOY-MAKING IN SCHOOL AND HOME

For Canoe begin with an oblong $6\frac{1}{2}$ inches long (Fig. 65); width, twice the diameter of a penny. Fold in half along G H. Make half

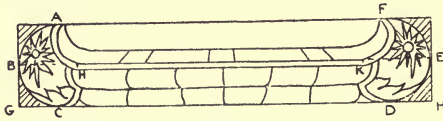

FIG. 65

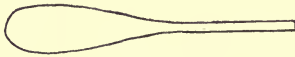

FIG. 66

circles A B C and F E D, at each end, by means of penny. Cut around A B C and D E F. Fold in half along B E. Join A by means of curved line with B E, and F with B E. Cut along A H K F. Gum the canoe together at A B C and F E D. Cut out three seats to go in the middle; make drawings on the canoe. Paddles must be cut to go with canoe (Fig. 66).

An Indian Cradle can be made in the same way as the quiver, but with the point G cut off as in Fig. 67, and markings put on the front to look as though the cradle were laced up. String is attached for hanging the cradle to the mother's back or to a tree.

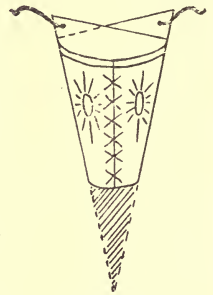

FIG. 67

Canoe, quiver and cradle look effective cut out of brown paper and chalked with yellow or red chalks.

A Clock Tower (Fig. 69). Begin with an oblong 10 inches by 6 inches. Fold in eight parts, and cut off three. Fold the remaining portion A B C D

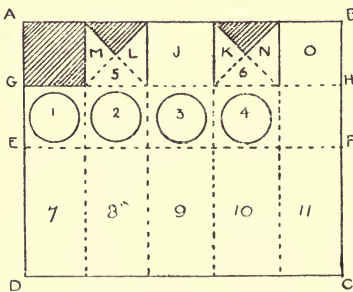

FIG. 68

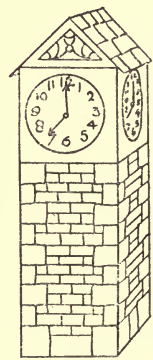

FIG. 69

in half along E F; fold A F in half along G H. Fold along

dotted lines, cut along dark lines and cut off the shaded portions as in Fig. 68. Draw clock faces in squares 1, 2, 3 and 4, a pattern of some kind in triangles 5 and 6, and mark bricks on the sides 7, 8, 9, 10; side 7 is gummed over 11, which, therefore, is not seen (Fig. 69).

To fasten Tower together. Fold the sides 8 and 10 at right

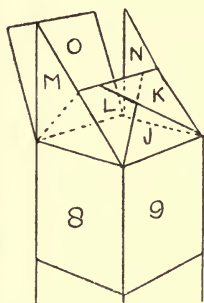

FIG. 70

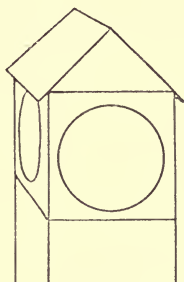

FIG. 71

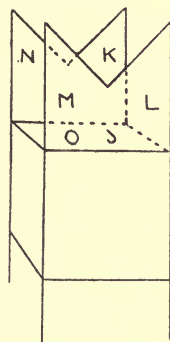

FIG. 72

angles to 9; bend J forward and gum to it both K and L (Fig. 70), and cut off the part of J that projects beyond K and L. Now gum the side 7 to 11, bend o toward J; gum N to o and M to o and cut off the portion of o that projects beyond M and N. A piece of paper, painted to represent slates, can be gummed over the roof, so that it projects slightly, as in Fig. 71.

A simpler way of fastening the tower together is to gum o to J, M L and N K standing upright as in Fig. 72.

A Windmill can be made in the same way. The sails are made as described in the match-box windmill (Fig. 97).

A Lighthouse (Fig. 73). Take an oblong piece of paper, about $8\frac{1}{2}$ inches by 6 inches. Fold down each shorter edge for $\frac{1}{2}$ inch and cut the flanges as described in the case of the bucket (Fig. 56). Bend the flanges inward, curve the paper round and gum together to form the body of the lighthouse. Cut

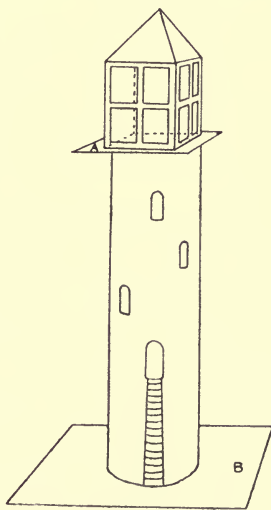

FIG. 73

two squares of paper, one smaller than the other, gum the smaller one **A** to the flanges at the top of the cylinder; colour **B** blue and gum it to the flanges at the bottom. Make a small lantern, as in Fig. 51, to fit the top of the lighthouse. In this case it is better to gum the triangular tops of the lantern together. The door, windows and staircase should be drawn and the lighthouse coloured grey before fastening the cylinder together.

CHAPTER V

MATCH-BOX TOYS

MANY simple and effective toys can be made from match-boxes. The great advantage of these toys is that the children can readily supply the materials themselves. In every case the toys explained here have been made by young children, whose ages vary from four to seven. The materials used are match-boxes, matches, paper of different kinds, white, brown, coloured, and cardboard, while in some toys corks and silver paper have been introduced. For sticking paper on to the boxes, gloy or vegetable glue is suitable, but when matches have to be fastened into or on to the boxes it is best to use liquid glue or seccotine. Some of the toys can be made more effective by colouring them with crayons.

A Canoe. To make the canoe (Fig. 74) the inside portion of the match-box is gummed to a piece of stiff paper or cardboard



FIG. 74

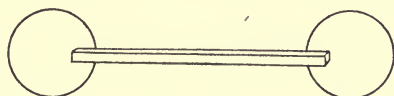

FIG. 75

pointed at each end. Strips of paper gummed to the sides of the box form the seats. The paddle (Fig. 75) is made of a match, to the ends of which paper discs are gummed. To get these circles the children can use farthings and draw round them. The paddle and the seats can be coloured with brown crayons.

A Kayak. For the kayak (Fig. 76) a piece of paper is measured to fit over the box; it is doubled in half and a small hole cut in it, then gummed to the sides of the box.

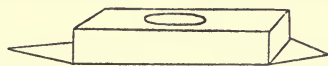

FIG. 76

A Motor-car (Fig. 77). The car consists of a match-box without the cover. The seats are of white paper. The following

54 TOY-MAKING IN SCHOOL AND HOME

method of making the seats is the simplest for little children. Let them measure and cut a piece of paper, $A B C D$, that will just cover

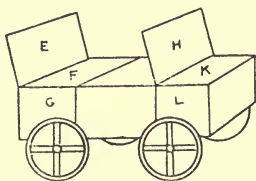

FIG. 77

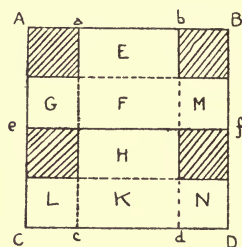

FIG. 78

the box from side to side, making bends $a c$ and $b d$ where the edges of the box come. Fold paper into four as in Fig. 78. Cut along $e f$, and cut off the shaded portions and fold as in Fig. 79. Gum the parts G and M to the side of the box.

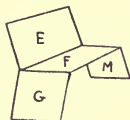

FIG. 79

Wheels for all match-box toys are made from stiff paper or cardboard, the circle being drawn from a farthing, or, where larger wheels are necessary, from a halfpenny. The spokes are drawn on the wheels. These can either be gummed to the sides of the match-box, or, if holes are made in the wheels, they can be fastened to each end of a match, which is then glued to the bottom of the box.

A House or Barn. From the covers that are left, after making the canoe and the motor-car, a house or barn can be

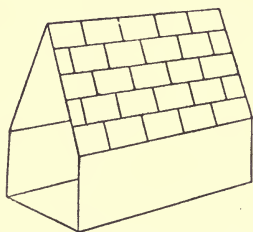

FIG. 80

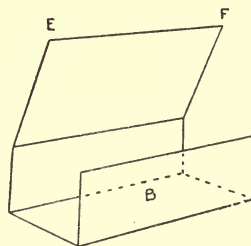

FIG. 81

made (Fig. 80). One cover is cut open and the top bent back as in Fig. 81. A portion of the second cover is cut off (Fig. 82).

Side A is then gummed to B, and c D is fastened to E F by meant of a piece of folded paper covering the whole of the roof.

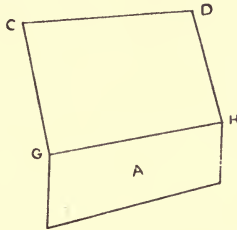

FIG. 82

This paper is double the size of c D H G (Fig. 82), is coloured grey or blue to represent slates, and folded along the middle.

A Sentry-box. This is an easy toy to make. The children will notice that one end of a match-box is double—that is, one piece of wood overlaps the other. If they unfasten these and bend them out they form the roof of the sentry box (Fig. 83). A piece of paper can be pasted behind to fill up the hollow. The toy looks more effective if covered entirely with brown paper. A soldier can be cut out of paper, coloured and gummed to the bottom of the box.

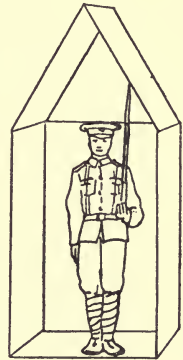

FIG. 83

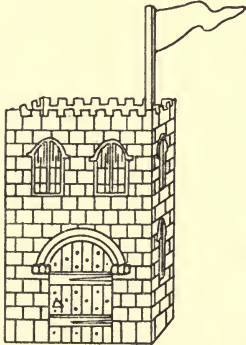

FIG. 84

A Castle. A castle can be made from the cover. A piece of paper is cut to fit round it, doors and windows are marked on it with pencil or crayon, and one edge is cut to represent battlements (Fig. 84). The flagstaff is a match glued inside. A larger castle can be made by fastening two or more covers together.

A Jack-in-the-box. These toys are so simple that the diagrams almost explain themselves. In the case of the Jack-in-the-box the children like to decorate the half-opened match-box with coloured paper. The little figure is made of bits of wool, a

piece of cotton is tied round the neck and put through a hole in the top, a match is tied to the cotton to prevent it slipping back ;

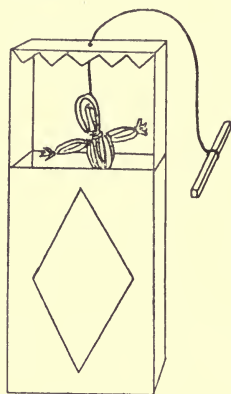

FIG. 85

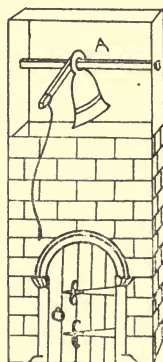

FIG. 86

another piece of cotton tied to the waist of the doll pulls it down (Fig. 85).

A Belfry. In the belfry the back of the box at A has been cut out, the bell is made of paper or cardboard, covered with silver paper (Fig. 86). A match stick is passed through a hole in the bell, and gummed to each side of the box. Another match is gummed to the bell, and a piece of cotton attached for ringing.

A Van (Fig. 87). The van is made from the inside of a match-box ; the cover is of brown paper gummed inside the sides of the

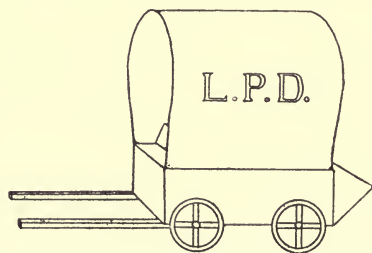

FIG. 87

box. The seat is also of brown paper, while one end is bent back for the flap of the wagon. The shafts are made of matches.

A Milk-cart (Fig. 88). The can is a cork covered with silver paper, which is used to cover chocolates, etc. The paper can be screwed into a little knob at the top. In Fig. 88 the wheels are the same size. Two are fastened to a match for the axle, which is then glued underneath the box; the third wheel is glued between two matches, which are fastened underneath the box. In Fig. 89 the side wheels are larger and a cardboard set of shafts is made for the small front wheel.

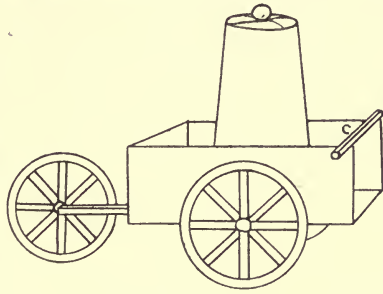

FIG. 88

Fig. 90 shows the shape of these shafts. The shaded portion is bent at right angles to the shaft and glued under the box. The small wheel can be gummed between these shafts, or, if the shafts are fastened on with a space between them, and holes made in each end, a piece of match stick, on which the small wheel is

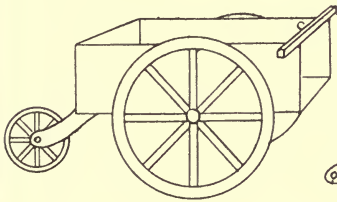

FIG. 89

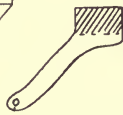

FIG. 90

mounted, can be passed through the holes. A match is glued across the back of the box (Fig. 88) to form the bar by means of which the cart is pushed along.

A Field Gun. Fig. 91 shows how the match-box is cut. The gun is made from a roll of brown paper. A piece 4 or 5

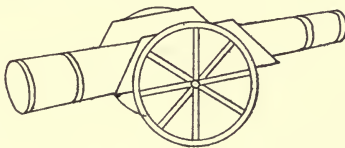

FIG. 91

inches square is large enough. Yellow bands can be chalked round the cannon. The wheels are made of circular discs, the size of a penny. Shots can be made from silver paper, or from plasticine.

A Field Gun and Limber. The gun in Fig. 92 is mounted somewhat differently. A is one-third of a match-box cover, with one narrow side cut away, covered with dark grey paper; two holes are made in it opposite each other; the gun has a match or

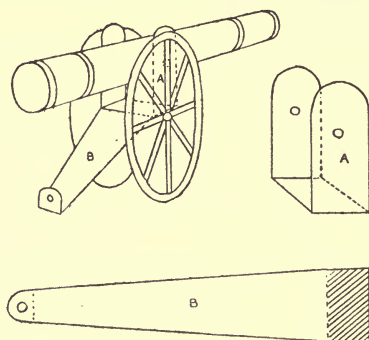

FIG. 92

piece of cane passed through it, and the ends of the match or cane pass through the holes in A.

B is a piece of cardboard or stiff paper shaped as in diagram: the shaded portion is gummed underneath A.

The Limber (Fig. 93). This is made from a match-box (c), covered with dark grey paper and fitted with a cardboard cover

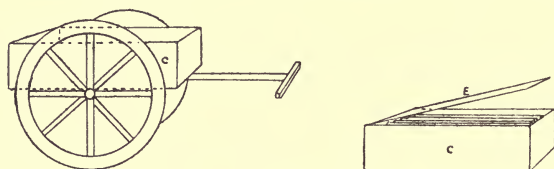

FIG. 93

E, similarly coloured. Match sticks, coloured black, form the shots. The handle consists of two match sticks, or two strips of cardboard, glued together. The wheels must be the same size as those for the gun.

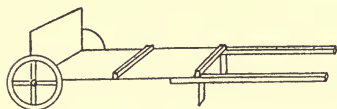

FIG. 94

A Porter's Truck. This is made from a box of which three sides have been cut away (Fig. 94). It can be covered with brown paper, and matches can be glued across it. The handles are of

matches, the legs of stiff paper fastened to the bottom. The children can make little paper parcels and boxes to put on the truck.

A Sweep's Barrow. The figure (95) shows how the match-box is used. A bundle of matches tied together represents part of the sweep's outfit. The broom is made from a roll of paper, the ends of which have been cut into a fringe. The broom and matches can be darkened with crayons or ink.

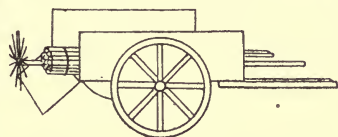

FIG. 95

A Windmill (Fig. 96). Prepare the inside of a match-box as

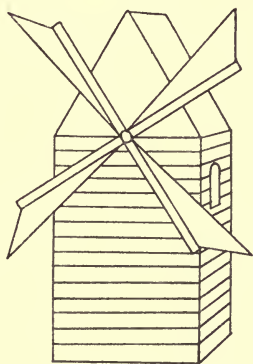

FIG. 96



FIG. 97

described in the case of the sentry-box, and place it inside its cover, securing it with a little gum. Paste a piece of paper in front to hide the hollow.

The sails of the windmill are made of brown paper, cut as in Fig. 97, and gummed to strips of cardboard which form the framework of the sails. The whole can then be fastened to the box by a paper-clip.

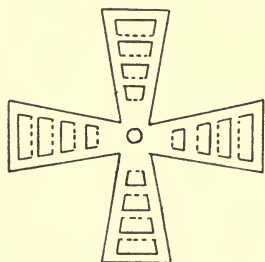

FIG. 98

To make the Sails turn. Bore two holes through the windmill; round a match stick by rubbing it with sand-paper; glue the sails to one end of it, pass it through the holes and glue a circle of cardboard to the other end to prevent it slipping back. Fig. 98 shows a more complicated but very

effective way of making the sails. The paper is cut along the dark lines and bent back along the dotted lines.

A Tram-car (Fig. 99). For this toy two insides of match-boxes are needed. The children could cut and gum to one box a

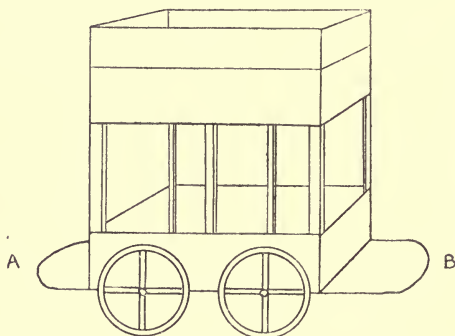

FIG. 99

piece of cardboard A B. Then into this box are gummed six matches of the same length. While these are drying the wheels can be made and the top prepared. The top is a box turned over with a piece of paper gummed round the edge. The paper should be coloured yellow. The projecting paper forms the rail round the top of the car. When the matches are quite firm the inverted box is placed over them.

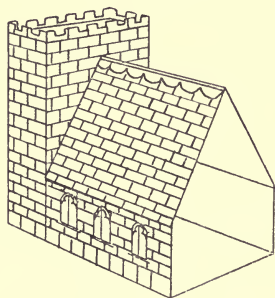

FIG. 100

A Church (Fig. 100). This is made from a combination of the barn or house and the castle. A strip of paper can be gummed along both sides to keep the two parts together.

A Match-box Train (Fig. 101). The engine is a match-box turned upside down, to which is gummed a cork covered with red or green paper. The broad end of the cork has been sand-papered to make it more equal to the other end. The funnel is a piece of cardboard blackened and inserted into a slit in the cork. Half a match-box glued to the cork forms the cab. The coal tender is a match-box on wheels; a piece of brown paper can be pasted

round one end to form the back and the sides. The simplest way of making a carriage is to fold a piece of paper into three, mark on

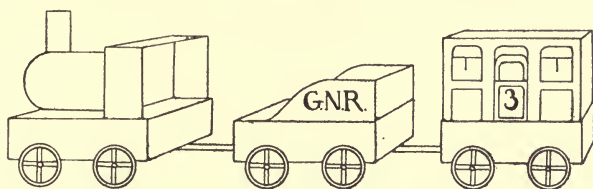

FIG. 101

it the door and the windows and gum it to the inside of the box. For this piece of paper the children can get the measurements from the match-box.

In order to make a long carriage like a real train a child suggested gumming two match-boxes together, end to end.

When a long train was complete the children at once wanted to make a station (Fig. 102).

For this purpose two or three match-box covers can be fastened together by covering them with white paper (marked to represent

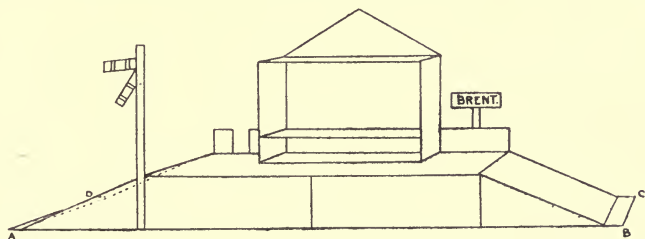

FIG. 102

the boards of a platform) and gumming them to a piece of cardboard, $A B C D$. The paper must be left long enough at each end to be gummed to the cardboard and form the slopes of the platform. The waiting-room or shelter is a match-box gummed to platform as in diagram, with a triangular piece of paper pasted behind to form a roof. A seat can be pasted inside. The name of the station, signals, and a signal-box (a half-opened match-box standing on end) can be added.

A Railway Bridge. Gum two sets of four match-box covers together as A and B in Fig. 103. Next, take a half-opened match-

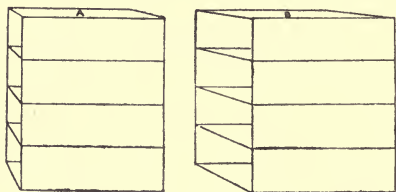

FIG. 103

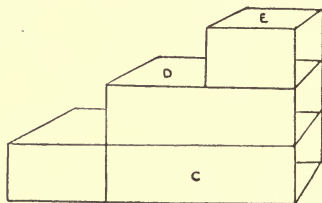

FIG. 104

box (C in Fig. 104), gum cover securely to box, turn it upside down and to it gum cover D, and to this, half a cover E. Fasten this to A by strips of paper gummied on each side (see shaded part in Fig. 105). B has a similar arrangement fastened to it. These portions form the two sides of the bridge, but the steps so obtained are too high and extra

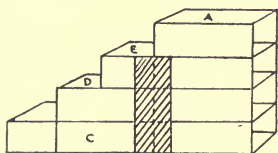

FIG. 105

paper steps must be made. For each of these take a piece of stiff paper L M N O (Fig. 106). L M equals width of match-box; M O equals three times thickness of box. Fold in three along T U and R S; fold L U and T S in halves and bend paper to form steps. L Q is gummied to A and R O to E. Repeat for each intermediate step.

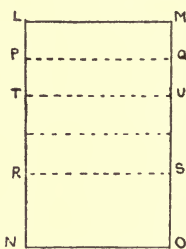

FIG. 106

Next cut a piece of cardboard the width of the match-box and long enough to leave a suitable distance between the two ends of

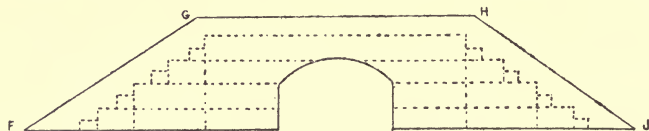

FIG. 107

the bridge to allow the match-box train to pass through, or two trains to pass each other. Gum this to the top of A and B (Fig. 107).

Next cut a piece of paper F G H J to fit across both parts of the bridge and to project to form railings or a wall, cut out the

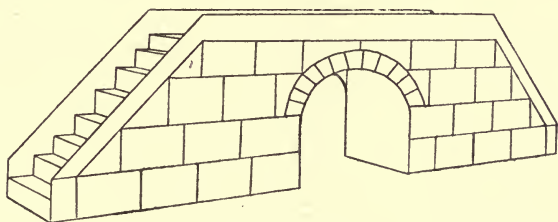

FIG. 108

archway, colour to represent stones or bricks, and gum to bridge ; cut and colour a similar piece for the other side (Fig. 108).

CHAPTER VI

MORE COMPLICATED MATCH-BOX AND CORK TOYS

A Paddle-wheel Steamer (Fig. 109). The cover of a match-box, A B C D, is covered on top and bottom with two pieces of stiff

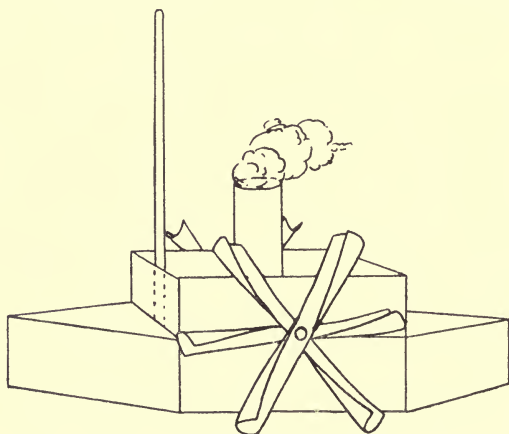

FIG. 109

paper or cardboard pointed at both ends (Fig. 110). A long strip of paper is cut, E F G, etc., and fastened round the cover and projecting cardboard. The box is gummed on to A B C D. The

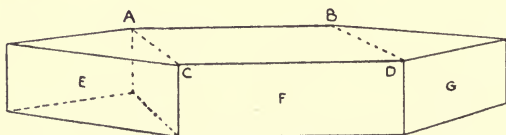

FIG. 110

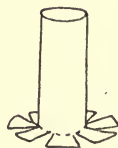

FIG. 111

funnel is made of a roll of red paper (Fig. 111). The mast is a roll or strip of paper gummed to inside of box.

The wheels are strips of paper held together by a paper-fastener,

the paper being bent sideways. The paper-fastener clips the wheel to the side of the box. A piece of cotton-wool can be put into the funnel for smoke.

A Castle and Drawbridge (Fig. 112). A and B are match-boxes, with the shorter sides cut off, gummed to a square piece of cardboard (4-inch side). Along the bottom of these a piece of blue paper is gummed to represent the water in the moat. C D F E is a piece of paper with archway cut out, gummed to sides of boxes A and B, and behind this are gummed match-box covers G and H. The drawbridge is a piece of stiff paper hinged to C D, and has match sticks gummed across it. Holes are made in the bridge and wall through which pieces of thread are passed; the ends behind the drawbridge are fastened to a match.

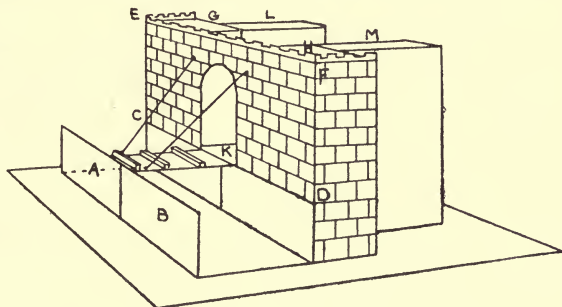

FIG. 112

K is a box turned upside down and gummed to G, H. L and M are covers forming a passage from drawbridge. The castle can be enlarged by adding more boxes.

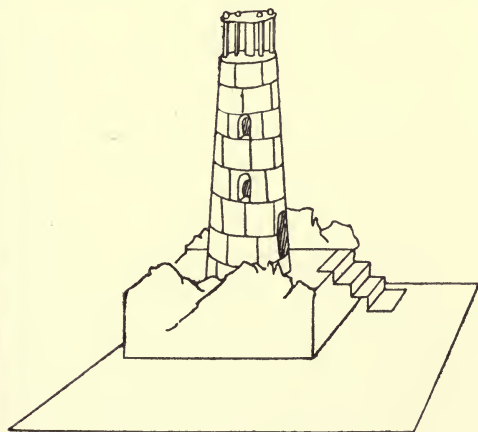

FIG. 113

A Lighthouse (Fig. 113). This toy is made from two corks gummed together and fastened to the cover of a match-box which is gummed to a square of cardboard covered with blue paper. Round the box, paper, cut and coloured to represent rocks, is pasted

and paper steps are fastened to one edge. Into the top cork four pieces of matches are inserted and between them is placed a small roll of red paper. A small piece of paper with four holes in it is placed on top of the matches. The corks can be coloured grey, and windows and doors painted on them. The top cork must be filed to fit the lower one, and its upper end filed to make it narrower.

An Airship (Fig. 114). The airship is made from three corks glued together, the thickest cork being in the middle. Matches are inserted at each end. Four matches are inserted into the

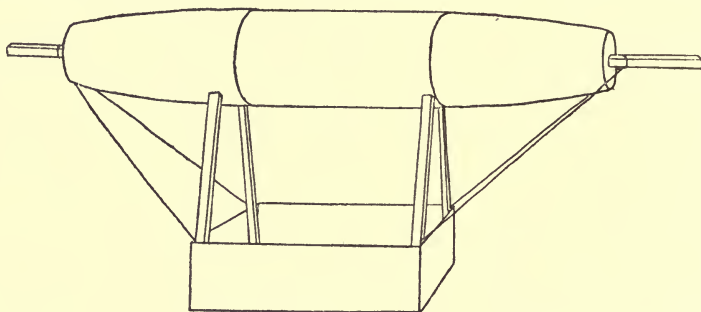

FIG. 114

corks and their other ends glued into a match-box. A piece of black thread is fastened to the matches as shown in the diagram. Matches and corks can be coloured dark grey.

A Bristol Biplane (Fig. 115). A B, C D are two strips of paper, in length about four times the length of a match-box, in width

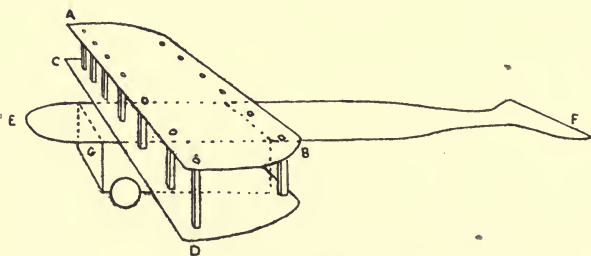

FIG. 115

nearly three-quarters the length of a match-box. These are fastened together by match sticks, as shown in the diagram.

EF is cut from a piece of paper as long as AB and about the width of a match-box. This paper is doubled along EF and marked



FIG. 116

and cut out as in diagram (Fig. 116); then unfolded and pasted on the bottom of a match-box (G), to which four small cardboard wheels are pasted. ABCD is then gummed along the back of the box G at right angles to EF.

A Bird-cage (Fig. 117). This is made of two small squares of cartridge paper fastened together by matches, as shown. When making the holes

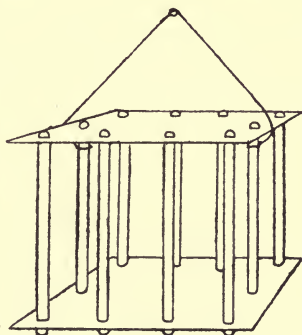

FIG. 117



FIG. 118

the two pieces of paper should be placed together. A piece of cotton is fastened to the matches so that the cage may be hung

up. A bird for the cage is made from a small cork, as in Fig. 118. The legs are two halves of a match; the tail must touch the ground in order that the bird may stand.

A Travelling Menagerie (Fig. 119). Cages are made from match-boxes. The box is mounted on wheels, match sticks are

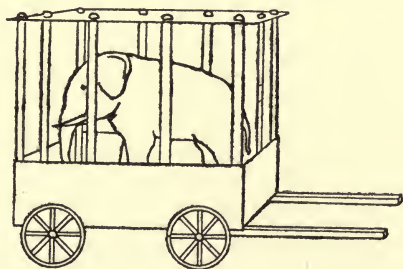

FIG. 119

glued inside the box, and a piece of paper with holes in it is fitted to the tops of the matches.

68 TOY-MAKING IN SCHOOL AND HOME

Animals are cut out of paper and coloured. If these animals are cut from a folded piece of paper (Fig. 120) they will stand.

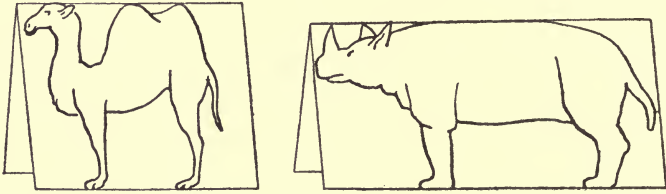

FIG. 120

The various cages can be harnessed to horses. A caravan to accompany the menagerie is shown in Fig. 121. A piece of paper folded in three is gummed to the inside of a match-box.

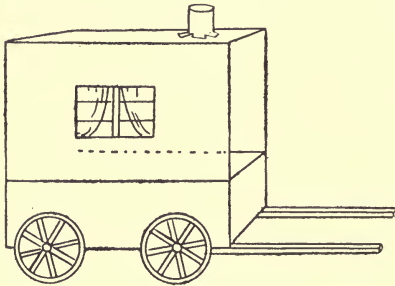

FIG. 121

On the sides windows are marked, and a round paper chimney is gummed to the top.

A Fire-escape (Fig. 122). The ladder is made from two

narrow strips of cardboard; holes are made in these and match sticks inserted. The ends of the matches should be slightly filed or sand-papered. B is a match-box, one end, c, of which is bent forward. To this end strips of cardboard, C D, E F are gummed, and across them other strips, F D and G H. Wheels can be gummed on as in the figure. L and M are cardboard strips gummed to box and ladder to help to keep it in position. Thread could be attached as shown in diagram, and an additional ladder made to stand between L and M.

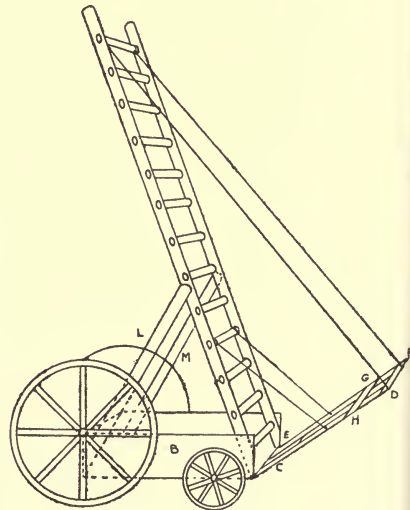

FIG. 122

A Mangle. A is a match-box turned upside down to which are gummed two corks which have been filed to make them perfect cylinders (B and C in Fig. 123).

The two corks are gummed together and a strip of paper E is bent round them, gummed to their flat ends, and also to the sides of the match-box as at F. K and H are pieces of cardboard shaped as in diagram and marked to imitate the iron legs of a mangle. These pieces are gummed to the inner sides of the match-box to form the legs. G is a circle of cardboard (on which spokes should be marked) fastened as shown in diagram; to this a cardboard or match handle, L, is attached.

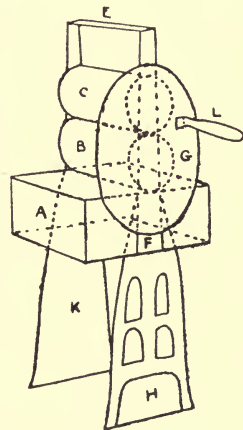

FIG. 123

A Submarine (Fig. 124). A, B, C are corks filed to the shapes shown in Fig. 124, and glued together. E F is a piece of cardboard, narrow and pointed at each end, gummed to the corks. Before fastening it on holes should be made in it round the edge. Through these small pins are put and pushed into the corks to form a railing, and round them a piece of black cotton is tied. G is a small cork,

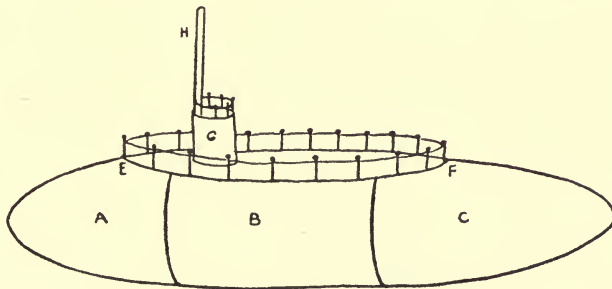

FIG. 124

or a part of a large cork made small by filing, gummed to E F; a match, H, is inserted to represent the periscope. Pins are inserted round G with black cotton tied round them. The corks, cardboard and matches should be coloured grey.

Older children can make this submarine so that it will float. The corks A, B, C must be fastened together by pieces of wire

70 TOY-MAKING IN SCHOOL AND HOME

passing through them. The deck is made by filing the corks flat along the top, E F, and pins are inserted around it. Cork G is fastened to B by a pin. A narrow strip of lead is cut and pointed at each end, these ends are bent at right angles and are inserted into slits in A and B.

This submarine will float well, and makes a very effective little toy.

It could be painted with grey enamel.

A Barrel Organ. Figs. 125, 126, 127 show how a barrel organ

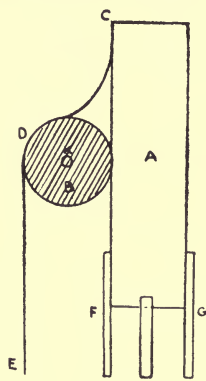

FIG. 125

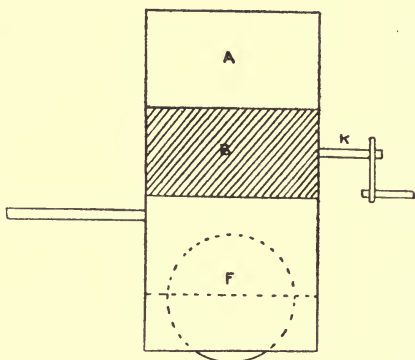

FIG. 126

can be made from a cork and match-box cover. A is a match-box cover, a cork; B, is made a perfect cylinder by means of sand-paper,

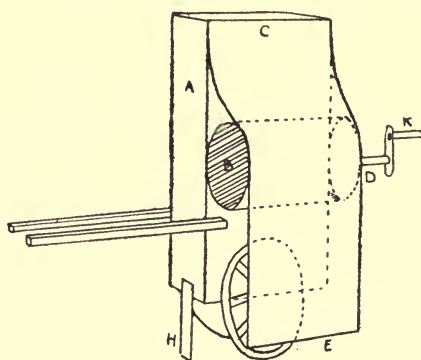

FIG. 127

and gummed to side of cover. It is kept in its place by a piece of paper, C D E, which is gummed to cover and also to the cork.

Wheels F and G are gummed to the sides or made to revolve on axles as described in Chapter II. The handle K is made of a match stick and bent piece of cardboard. Support H and handles are made of cardboard.

Note that the piece of paper C D E reaches nearly to the ground. This prevents the toy from overbalancing. Paper, etc., must be suitably coloured. The match-box cover might have brown paper pasted round it.

CHAPTER VII

CORK ANIMALS HARNESSSED TO SLEDGES, ETC.

For these toys plenty of corks are necessary, and files or sand-paper; also some pointed instrument, a long nail or bradawl, for making holes in the corks. Four of them are shown in Plate III.

Horse and Cart. Gum wheels (size of penny) and matches for shafts on the match-box as in Fig. 128. File or sand-paper a cork

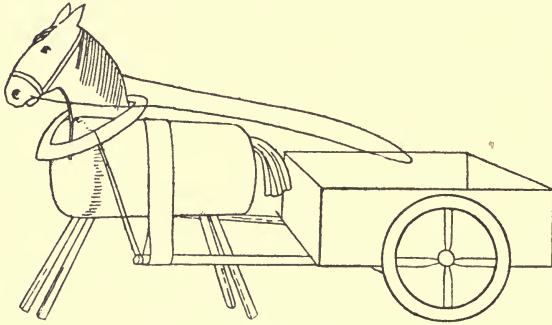

FIG. 128

quite smooth and round the edges. Cut a horse's head out of cardboard and colour it, make a slit with a knife in the widest part of the cork, insert the horse's head, insert the tail and four matches for legs. Gum a piece of paper on the horse's back, turn up and gum the ends of a paper strip to form loops for shafts to go through. These shafts can be gummed into the loops or fastened by thread or paper to a collar round the horse's neck. (This latter way is difficult for little children.)

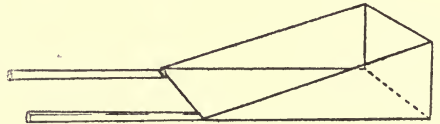

FIG. 129

The collar is cut out of paper. A piece of thread can be put through a hole in the horse's mouth for reins. Paper seats may be added to the cart.

A **Coster's Donkey Barrow** can be made in the same way, by substituting a donkey's head and cutting the box as in Fig. 129.

The van described in Chapter V might be harnessed to a horse.

Russian Sledge. To make the sledge cut two runners out of brown paper (as A in Fig. 130), and gum on each side of a match-

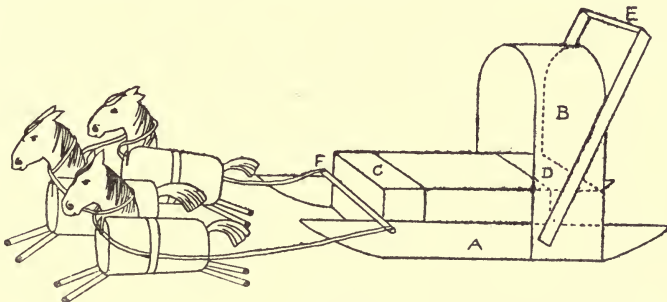

FIG. 130

box. Make two brown-paper seats, C, D, and gum on. Cut part of the cover of a match-box as in Fig. 131 to form the back of the sledge, B. Gum a brown-paper hood round this. A narrow strip of brown paper, E, is bent and fastened on as in diagram. A match or piece of cane, F, is gummed in front of the box, and to this the horses are harnessed. The horses are made as already described. A piece of silk or thread is looped round their necks and gummed under the straps of the outside horses, then tied to match stick, F.

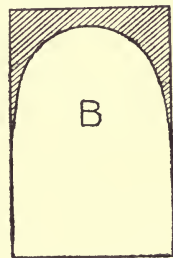

FIG. 131

This toy and some of those following will be found very useful to illustrate geography lessons.

A Reindeer Sledge (Fig. 132). Make the reindeer as the other animals. For the sledge the bottom of a match-box, A, and a piece of brown paper are needed. The brown paper should be in length one and a half times the length of the match-box and broad enough to wrap round a match-box and cover every side except one narrow side. Fold the paper in two along C B. Draw the runners on the doubled paper and cut out as in Fig. 133. Cut the straps E O and G P along the top K F and L H; double them along M and N. Gum M K F and N L H to the bottom of the match-box, A. Do the

same on the other side ; pieces M K F, etc., may be cut shorter for convenience in gumming. A piece of brown paper forms the back,

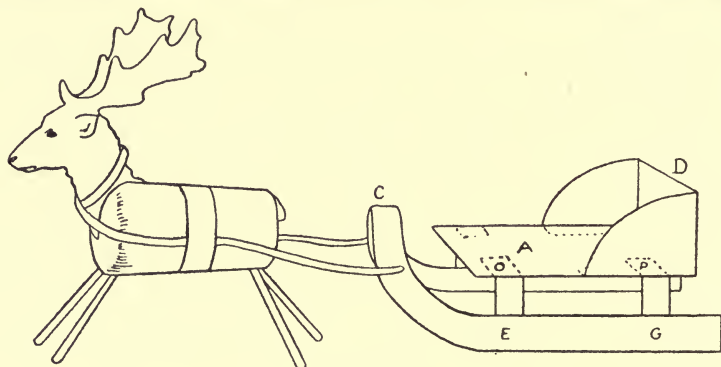

FIG. 132

D (Fig. 132). Finally, a piece of paper just the size of the match-box can be pasted over A to make the sledge look tidy.

The **Howdah** on the elephant's back, the next model, is a simple one, though difficult for some little fingers. A is a little paper case,

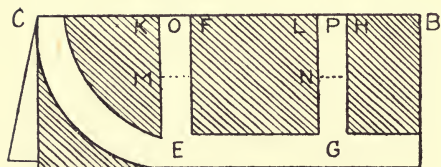

FIG. 133

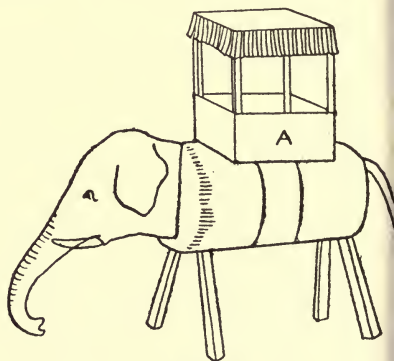

FIG. 134

in which four halves of matches are glued, a square piece of paper with a little fringe cut round is gummed on the top (Fig. 134).

South African Trek Wagon (Fig. 135). This is made from two match-box covers, A and B, fastened together by a strip of paper ; two match-boxes, C and D, are gummed to the top ; part of one box, D, is cut away as in the figure. A strip of brown paper must

be gummed along A and B, and a piece along the bottom of boxes c and D ; the outsides of c and D may be left their ordinary blue colour. A piece of bluish-grey paper, E, is folded in three and gummed inside the sides of boxes c and D, as in figure ; three or four divisions should be pencilled on each paper side. The wheels

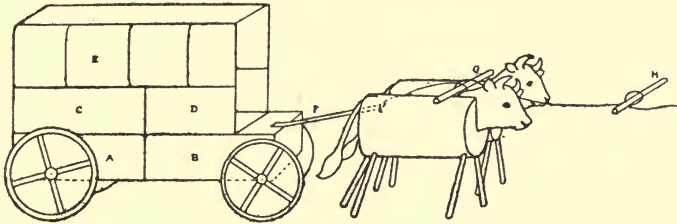

FIG. 135

are cut out of cardboard—the large wheels should be somewhat larger than a penny, the small wheels a little smaller—these are gummed to the sides. F is a strip of brown paper, through which a piece of thread passes to fasten the wagon to a stick, G, gummed across the oxen’s backs ; this can be fastened to a stick, H, and so on. Five pairs of oxen should be yoked to the wagon in this way.

An Irish Jaunting-car (Fig. 136). This toy is made from one match-box. First two cardboard wheels are cut out. These are

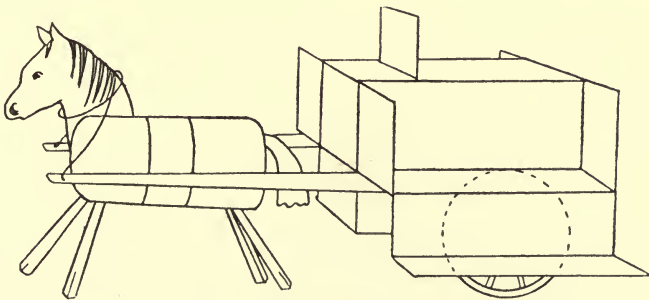

FIG. 136

gummed on each side of the match-box cover as in Fig. 137. The box is then cut in half (Fig. 138) and each half gummed to the cover, e.g. E F G H (Fig. 138) is gummed to A B C D (Fig. 137).

76 TOY-MAKING IN SCHOOL AND HOME

Two pieces of brown paper are bent as in Fig. 139, and gummed on, L M N O to H G J K, to form foot-rests. A piece of paper bent as in Fig. 140 and gummed on to the front closes up the hollow cover and forms the back of the driver's seat. A similar piece

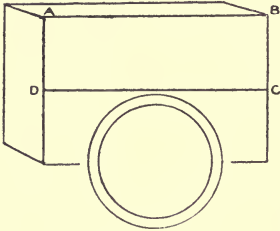

FIG. 137

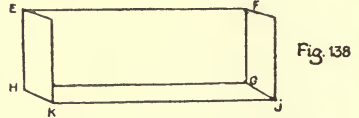

Fig. 138

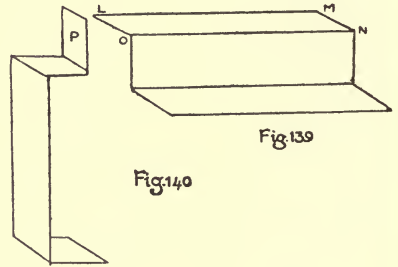

Fig. 139

Fig. 140

without the top, P, is gummed to the other end. Before putting on the seat the top may be covered with coloured paper, to represent the upholstered part of the car. Shafts of cardboard or cane are cut out and gummed underneath the seat to the cover and a cork horse is harnessed to them.

A Mexican Cart with Ox Team. A match-box is cut as shown in Fig. 141. Two pieces of narrow cardboard are cut the length

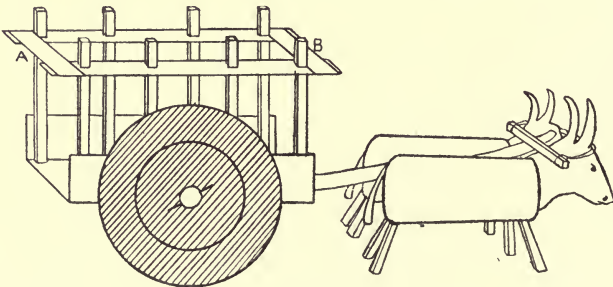

FIG. 141

of the box ; holes are made in these and four matches are inserted in each. These matches are then glued inside the sides of the box.



CORK ANIMALS



PLATE III

NOAH'S ARK



While these matches are drying the wheels can be made. The wheels are very large (the diameter nearly equal to the length of the box); they must be shaded to represent solid wood. Two strips of cardboard, A and B, are gummed on as in the figure.

A strip of brown paper gummed underneath the box forms the shaft, which can be gummed or tied to a match lying across the oxen, just behind their horns. This match is tied to the horns; this is the correct way of harnessing oxen.

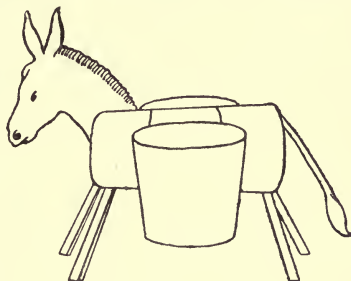

FIG. 142

A Donkey with Panniers. The panniers can be made of brown paper, in the same way as the mug described in Chapter IV; they are gummed to a strip of paper, which can be fastened to the donkey's back (Fig. 142).

A Persian Method of Travelling. The bottoms of the panniers, x and y (Fig. 143), are made from a small square of paper folded and cut as in Fig. 144. A is gummed on B and D on C; H on G and

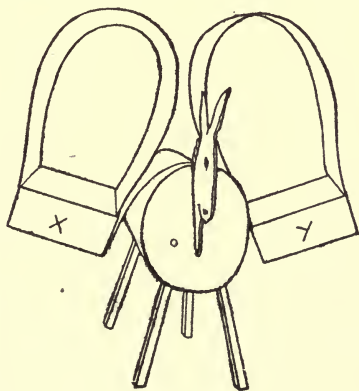

FIG. 143

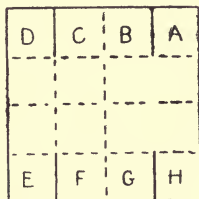

FIG. 144

E on F. The hood is made of a piece of brown paper gummed inside the paper boxes x and y. The panniers can be gummed to a strip of paper, the middle of which is gummed to the donkey's back.

78 TOY-MAKING IN SCHOOL AND HOME

An Eskimo Sledge (Fig. 145). The sledge is made of a match-box turned upside down; one end, A, is bent back as in

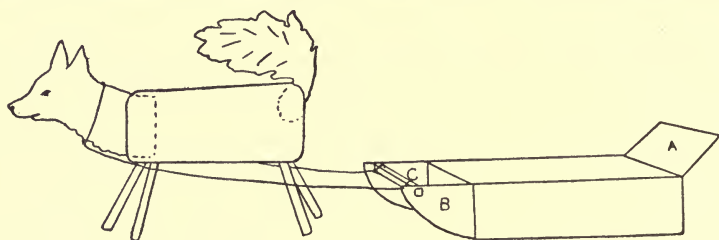

FIG. 145

diagram; the other end, B, is cut in half, bent outward and shaped as in diagram. A match, c, is glued to the ends, and

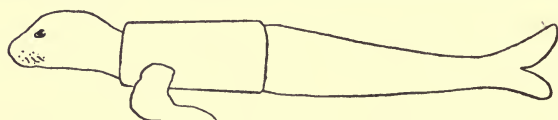

FIG. 146

to this is tied the thread that harnesses the dogs. A team consists of twelve dogs.

A Seal can be

made from a cork as in Fig. 146, and placed on the sledge.

A Belgian Milk-cart (Fig. 147). Two pieces of cardboard, A, are gummed inside a match-box; cover the box with paper, colour it green and mark as in the figure. Small corks should be filed to resemble milk cans. The carts generally contain six,

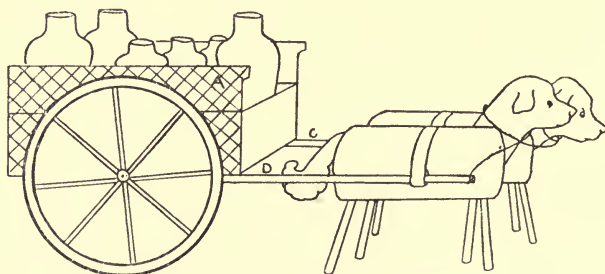

FIG. 147

three large and three small cans; they are yellow in colour. Two pieces of cane, or two match sticks, D and C, are glued under the cart for shafts; the ends are slipped through pieces of looped

paper gummed to the backs of the dogs. A piece of string tied to the ends of the shafts and round the dogs fastens them to the cart. The dogs are grey, and one is often smaller than the other.

Russian Dog Sledge (Fig. 149). This is made from a piece of paper folded along *c d* (Fig. 148); draw the sledge and cut out as in the diagram; bend along *k l m*. When opened out the sledge appears as in Fig. 149. Runners *A B* and *E F* are fastened together by strips of paper.

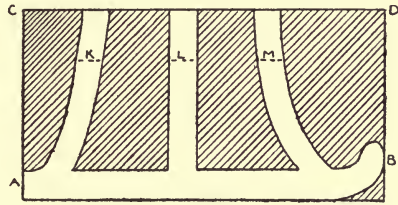

FIG. 148

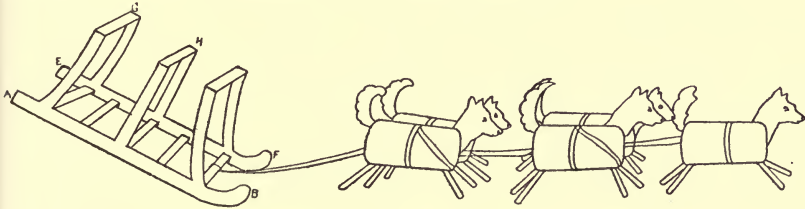

FIG. 149

A seat may be gummed over *G* and *H*. A piece of thread attached as in the figure harnesses the sledge to five dogs, made of corks.

CHAPTER VIII

MORE CORK TOYS

Cork Boats. Besides the submarine described in Chapter VI, many other boats can be made from corks, all of which will float well. The corks are joined together by pieces of wire passing

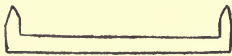

Fig. 150

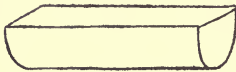

Fig. 152

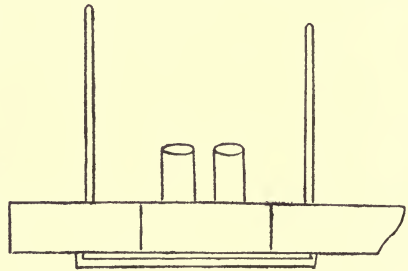

Fig. 151

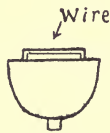

Fig. 154

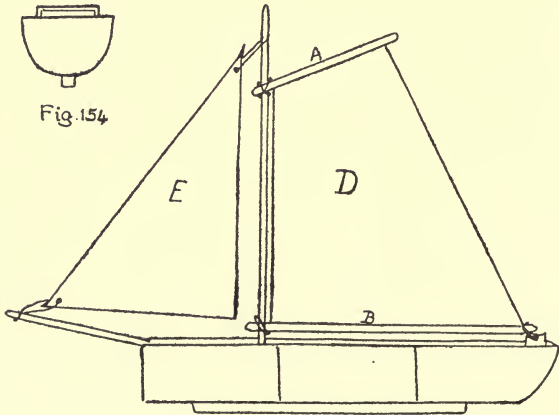

Fig. 153

through the middle. For the keel cut a narrow strip of lead (not more than $\frac{1}{4}$ inch wide); point both ends, bend them up at right

angles as in Fig. 150; make slits in the corks and push in the pointed ends of the lead. The keel is made more secure by driving pins or thin nails through the lead and the corks. The keel also helps to hold the corks firmly together and prevents them from slipping round on the connecting wire.

A Steamer (Fig. 151). Select three corks, as uniform in size as possible. Cut and file part of their round surface quite flat as in Fig. 152. Shape the bow and stern. The funnels are made of two small corks, fastened by pins. The masts consist of pieces of cane or thin sticks.

A Sailing-boat. A very pretty little sailing-boat can be made, as in Fig. 153. The sails are of glazed lining. The edges of this do not fray, so the sails do not require hemming, and as they must be as light as possible, this is a great advantage.

The gaff, A, is tied with thread to the mast, also the boom, B; both are pieces of cane, to which the mainsail, D, is sewn. The end of the boom is tied by cotton to a piece of wire at the stern, shaped as in Fig. 154. Care must be taken that the lead keel is exactly in the middle, and that the sails and masts are not too heavy, otherwise the boat will blow over on its side.

A Paddle-boat. Two pieces of cork pinned on each side of the steamer and cut as in Fig. 155, or even left round, make

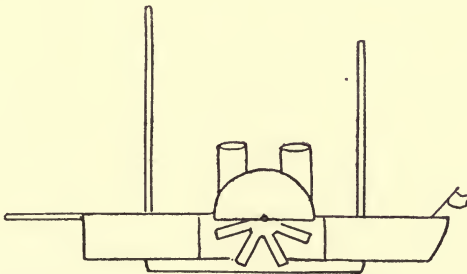

FIG. 155

very realistic-looking paddle wheels. Other models, such as a dreadnought, a fishing smack, etc., are easily made.

A Flying Proa of the Ladrões (Fig. 156). These boats are used chiefly in East Indian waters. They are remarkable for their

speed. Bow and stern are equally sharp pointed. One side of the proa is flat, and in a straight line from bow to stern (Fig. 157),

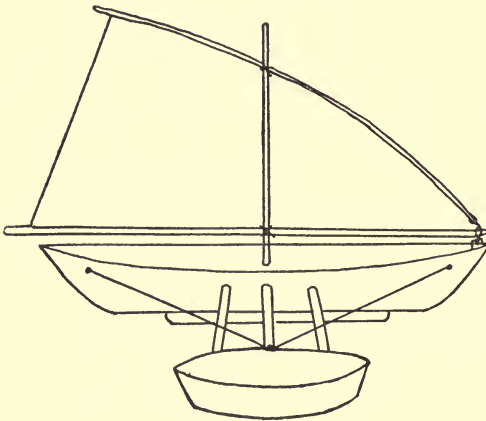

FIG. 156

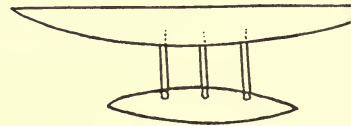

FIG. 157

but the other is rounded as in other vessels. The outrigger prevents the boat from turning over.

In the model the outrigger is made of a cork fastened to the side of the boat by match sticks or pieces of cane.



FIG. 158

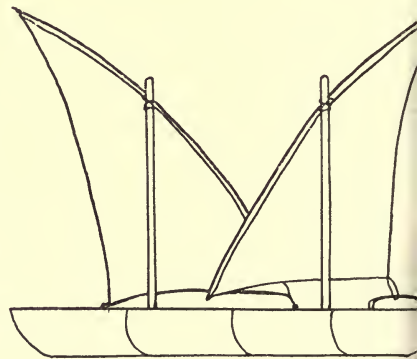

FIG. 159

An Eskimo Canoe is very easily made by pointing the ends very sharply and hollowing out a hole in the centre (Fig. 158). Fig. 159 shows an Egyptian Dahabieh. For this boat it is better to use four corks, as two sails are carried.

In the **Double Canoe** (Fig. 160) the two boats are joined by a thin piece of wood, A. A slanting hole is drilled in A for the mast.

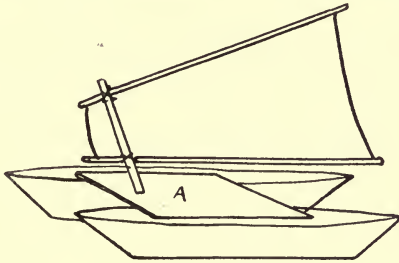

FIG. 160

Mast and yards are best made of cane. These little boats look wonderfully effective on the water.

Cork Wrestlers (Fig. 165). This is a very amusing toy and is very easily made. Cut and file two corks to the shape shown in Fig. 161. Drill a hole through the shoulders (*a a*) and hips (*b b*), and flatten these for the limbs to work against. The arms and legs are made of cardboard. Cut out the legs as in Fig. 162 and make holes in them. Pass a piece of stout wire through the hips and the holes in the legs and double the ends over, so that the legs will not slip off, but let them be loose enough to move freely.

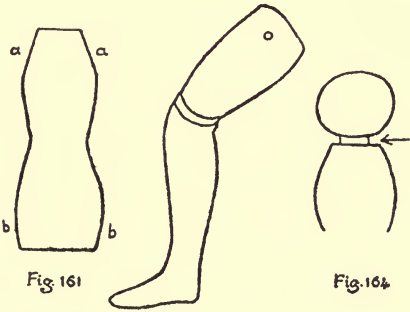

Fig. 161

Fig. 162

Fig. 164

In shaping the legs make them bend slightly at the knee, as this makes the figures more life-like in their movements.

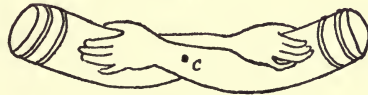

Fig. 163

The arms must be cut out in pairs as in Fig. 163. Make holes near the shoulders and one at *c*. Then fasten the arms to the body in the same way as the legs.

The heads are made of cork, the eyes, mouth, etc., being marked in ink. Cut a slit across the neck and one across the top of the body. Fasten the head to the body by inserting, with the

help of a pen-knife, a strip of calico into both these slits, so that the head is fairly close to the body (Fig. 164). The heads will move about as the figures wrestle. Paint the legs and arms.

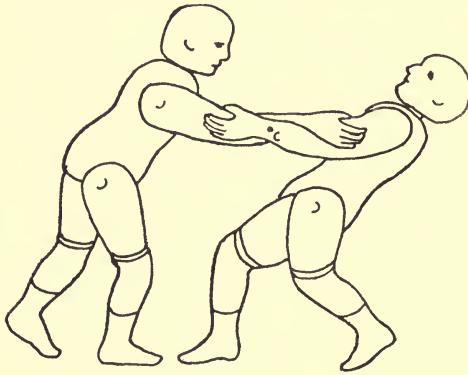

FIG. 165

pieces of lead may be glued to the feet.

Similar little wrestlers (Fig. 167) can be made from two wooden clothes-pegs (Fig. 166). Cut the pegs in two along the dotted line.

The upper part forms the head and body of a wrestler, and the lower parts are used for the legs. Drill holes through the bodies (at A in Fig. 166) and through the legs at the thin ends; fasten these to the body with wire.

For the arms two pieces of thin, flat wood are necessary, about 3 inches in length. Bore holes at each end and in the middle, shape them roughly with a pen-knife to represent the joined hands of the wrestlers. Fix these pieces to the bodies and work them as described in the case of the cork wrestlers.

Swiss Musical Figures. These amusing little toys were first invented by the Swiss. They are not musical in the sense that they produce any sound, but they dance about to music

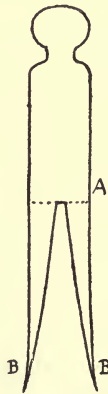

FIG. 166

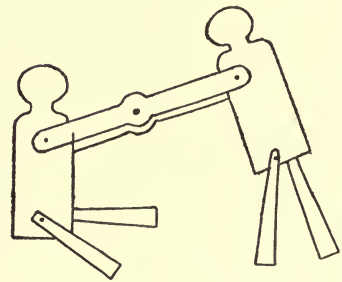

FIG. 167

when placed on a piano lid, or on any flat surface which vibrates.

The figures should be small and light and are easily cut out from a cork.

Shape a cork as in Fig. 168 and hollow out the centre (A). Cut out arms and legs of thin cardboard. Fasten the legs to a piece of wire passing through the hollow in the cork (B C in Fig. 168), so that they hang loosely. Fasten the arms to the shoulders with wire. Make four tiny holes in the bottom rim, E, with a pin; get some stiff bristles (from an old clothes brush), glue them into the holes and when firm cut them level, so that the figure stands upright, with the feet a little above the ground. A

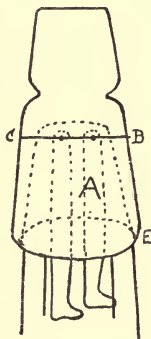

FIG. 168



FIG. 169

head is then made of cork, and a little dress and bonnet of paper added. This little figure, resting on the bristles, is affected by the slightest vibration. Other figures, such as a soldier, a clown, or animals, such as a dancing bear or a monkey, can be made on the same principle.

CHAPTER IX

CARDBOARD AND PAPER SHIPS (PLATE IV)

AN interesting series of ships can be made of cardboard and paper. These ships can be used to illustrate the history lesson or to illustrate a lesson on the evolution of the ship.

Materials. Cardboard of medium thickness (thin cardboard will bend and thick is difficult to cut), white paper—cartridge paper or ordinary exercise paper—and coloured paper or chalks, scissors and pen-knife, ruler.

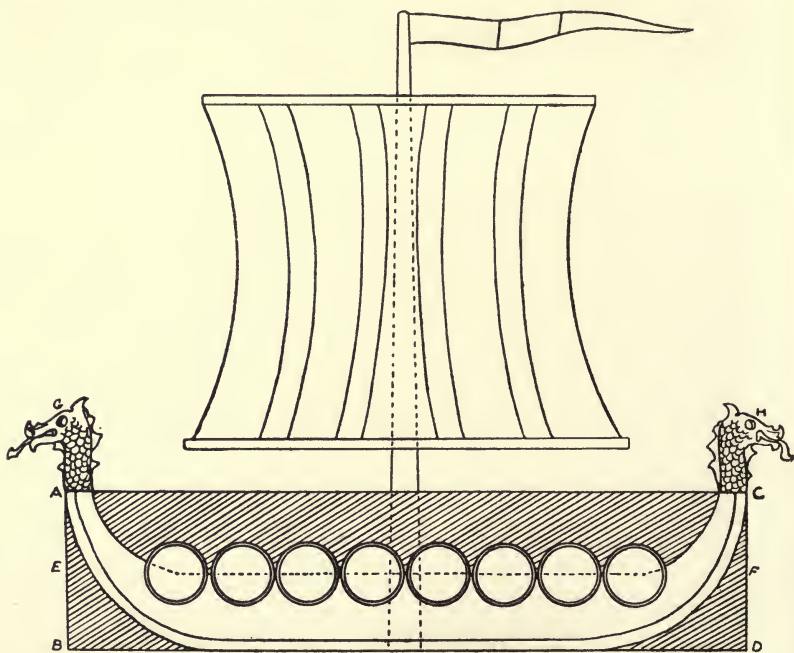
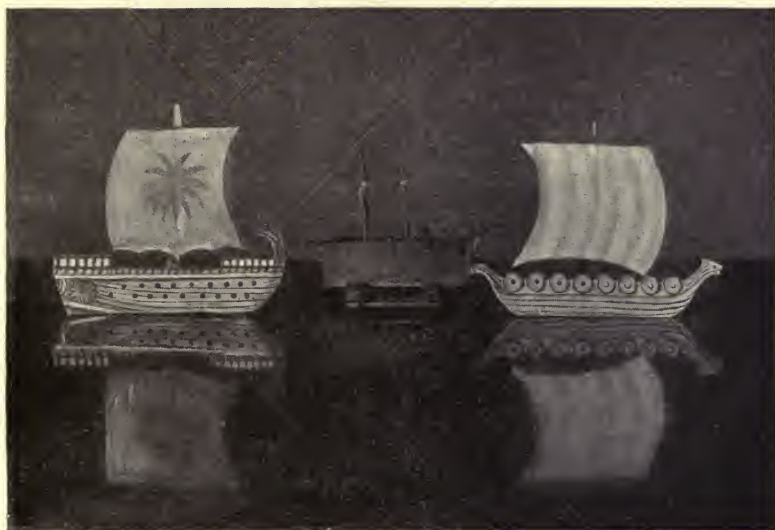

FIG. 170

The Viking Ship (Fig. 170). Give the children oblong pieces of cardboard, A B C D, about $8\frac{1}{2}$ inches by $2\frac{1}{2}$ inches. A line, E F,



CARDBOARD AND PAPER SHIPS
SCHOONER
(Part II, Chapter XIV)



drawn across the middle of the cardboard gives the top of the ship. The ship is then drawn on the cardboard, and the shaded part of the cardboard is cut away. Dragons' or serpents' heads are drawn on paper, cut out and gummed on to the stern and prow (as G and H); a tongue cut from red paper can be added to each dragon. (The 'dragon ships' were, as a rule, the largest, the 'serpent ships' being smaller and better adapted to sailing.) The mast is cut out of cardboard and gummed behind the ship; the sail is cut out of paper and gummed to the mast. The shields are cut out of cardboard and pasted along the sides. The ship may be painted white, blue, red, or any combination of colours; the warriors' shields were also of different colours. The sails were generally in coloured stripes, blue and white or red and white. Masts brown. For teachers who want to be historically accurate the following notes on the viking ship may be useful.

The viking ship (from ninth century onwards) was clincher-built, caulked with hair, and iron fastened. One ship we know to have been 78 feet long by $15\frac{1}{2}$ feet of extreme breadth; the ships varied in length from 50 to 150 feet. They had from twelve to thirty-five seats for rowers. Generally both ends of the vessel were alike, so that it could be steered from either end by the paddle, which was used everywhere until the invention of the rudder.

Standards and pennants were used, and possibly the two-armed iron anchor (for the Romans used it), so the children can cut out pennants and anchors for their ships.

Children delight in naming their ships and should be given some of the 'real' old names to choose from. These old names generally referred to the figure-head, which was of wood or metal, in the shape of the head of a dragon, deer, bird or other animal—e.g. *Dragon*, *Serpent*, *Raven*, *Deer of the Surf*, *Sea-king's Deer*, *Horse of the Sea*, *Sea-bird*, etc. To support the boat two pieces of cardboard are cut and folded, as N P O Q (Fig. 171). The cardboard must be half cut with a pen-knife along the line R S, so that it can be bent easily.

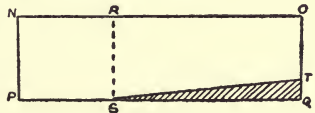

FIG. 171

The portion N R P S is gummed to the back of the ship, R S O Q bent at right angles to N P R S forms the support, with corner S T Q cut off, so that the ship tilts a little backward.

A Phœnician Warship, 480 B.C. (Fig. 172). This is made, as the viking ship, from oblong *A B C D*; pieces of paper, *E* and *F*, with railings drawn on them, are gummed on each end; a stern ornament, *G*, is cut out of paper and gummed at one end. (When a vessel was captured in olden days this was kept as a trophy.)

Small circles are drawn along the side of the ship to represent

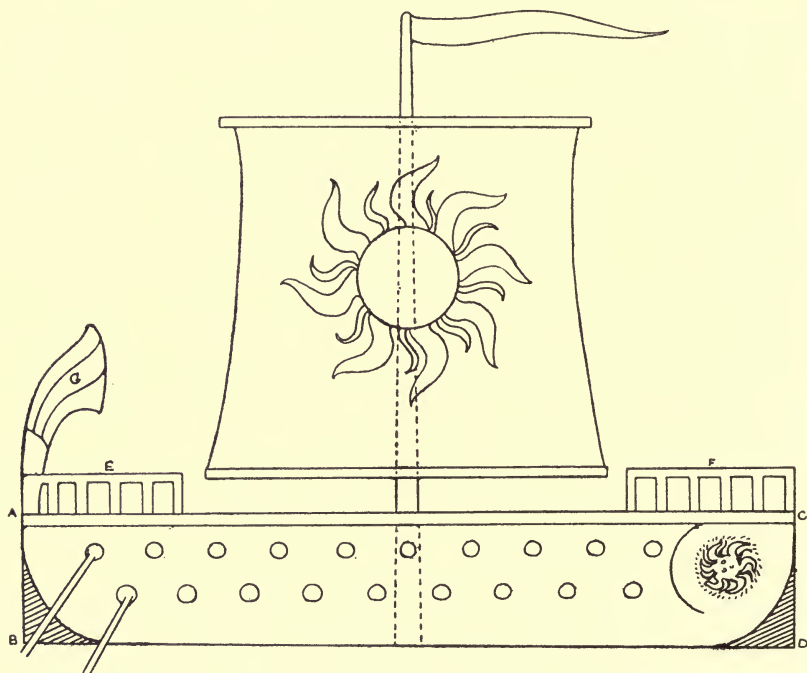

FIG. 172

the holes for the oars, or holes may be made in the cardboard and matches or strips of cardboard passed through for oars.

A device of the sun (common to Carthaginian vessels) should be drawn on the sail and prow. The ship can be coloured in stripes yellow and red, with one blue band near the top; stern ornament red and yellow; sail yellow with red sun.

The ships represented in Fig. 173 and in Plate IV are made in the same way. In all these a piece of cardboard forms the foundation. Masts, high funnels, anything likely to bend, should also

be cut from cardboard, but sails, stern or prow ornaments, railings, flags, etc., are best cut out of paper. By means of a needle and cotton, rigging can be added to the ships.

A Tudor Ship (Fig. 173). Tudor ships are difficult, because of their elaborate and lofty forecastle and poops. A simplified one is shown in the figure. This can be easily managed by the children if an oblong $A B C D$ is given them, divided into six parts length-ways, or if the oblong $E B F D$ is given them. In the latter case

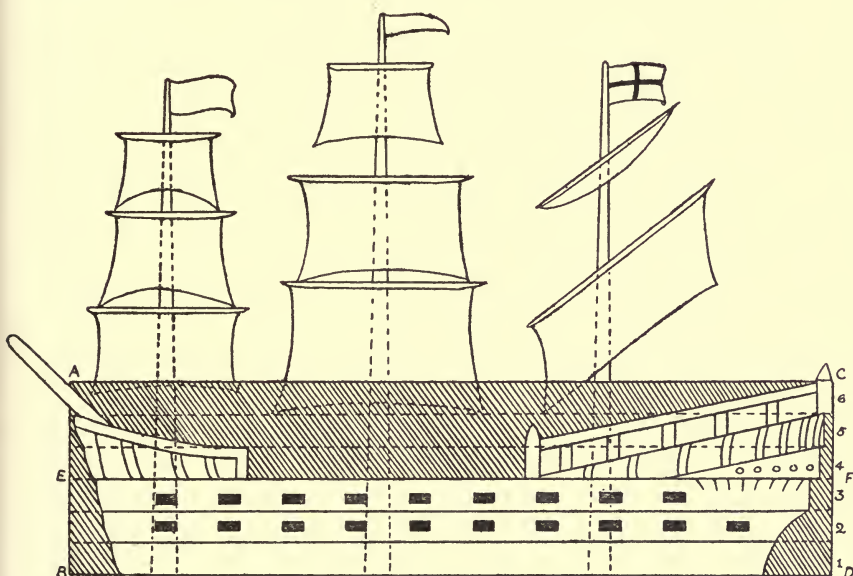

FIG. 173

the poop and forecastle are cut out of paper and gummed on separately. The ship is coloured red, yellow and blue, the sails white. The ship may be decorated with many flags.

The Cunarder has red funnels, with a black band at the top and two black lines underneath.

The Super-Dreadnought should be coloured dark grey. Children will delight to make, in a similar way, a Roman galley, Columbus' *Santa Maria*, in which he discovered America, the *Black Prince*, in which Sir Philip Sidney's body was carried to England, Britain's first Ironclad, etc.

Instead of cardboard supports pieces of wood (about $\frac{1}{4}$ inch thick, 1 inch wide, the length equal to that of the ship) can be half sawn through along the middle line and the ship inserted in this slit ; or pieces of wood (cubes) may be glued to the back. In the first case the surface of the wood should be painted blue to represent water.

CHAPTER X

CARDBOARD AND PAPER TOYS INVOLVING USE OF RULER, SET-SQUARE, SCISSORS, AND KNIFE

Materials. The cardboard used should not be too thick ; medium thickness is best (threepence a sheet). Almost any paper that is not too thin can be used for making hinges. All kinds of cardboard boxes will be found of great use in making shops, engines, etc.

Tools. *Scissors* with round points are safer for children to use, though perhaps not quite so suitable for the work.

Knives. For little children the carton knife, consisting of a small blade projecting not more than a quarter of an inch from the handle, is the best, as the smallness of the blade does much to prevent the children cutting their fingers.

For older children the "London" or "Leipsic" pattern is suitable, or they can use their pen-knives. These can be sharpened quite well on an ordinary knifeboard.

Rulers. The "non-slip" safety ruler is the best. It grips the paper well, and the depression between the raised edges enables the children to hold it steady when cutting.

Adhesives. Higgins' vegetable glue or seccotine.

A Pigeon-house (Fig. 178). On a piece of cartridge paper

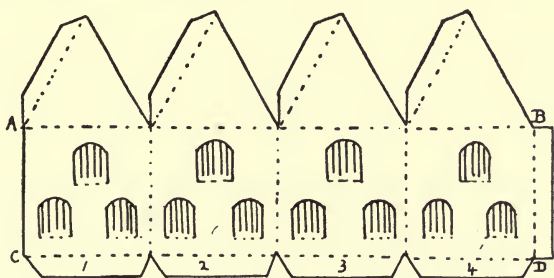

FIG. 174

draw an oblong 8 inches by 2 inches, and divide it into four squares (Fig. 174). On the top of each construct an equilateral

triangle. Make a flange about $\frac{1}{4}$ inch on the sides of the triangles, as shown in Fig. 174, and on the sides of the squares. Cut and fold back the doorways. Fold and gum together. Flanges 1, 2, 3, 4 should be folded in. Draw and cut out a square, side $2\frac{1}{2}$ inches (Fig. 175); gum the house on to this.

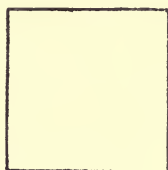

Fig. 175

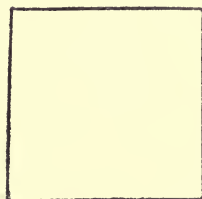

Fig. 176

For the post draw an oblong 8 inches by $2\frac{1}{2}$ inches (Fig. 177). Fold into five lengths ($\frac{1}{2}$ inch wide). Draw JK and LM $\frac{1}{2}$ inch from the ends of oblong EFGH. Cut along the lines, cut off the shaded portions, and fold along the dotted lines. Gum the two outer portions over each other to make a four-sided post.

For the base cut a square, the side 3 inches (Fig. 176), and to this gum the flanges at LM. Gum the

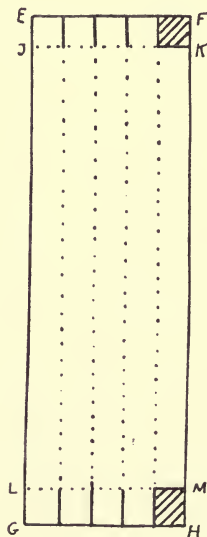

FIG. 177

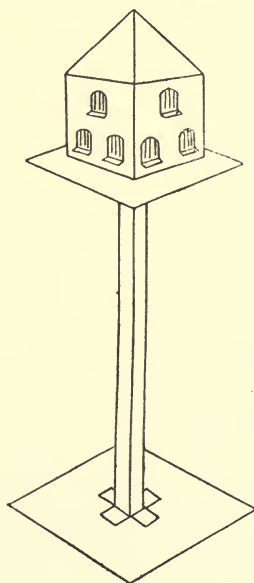

FIG. 178

house to the flanges at JK. To make the top stronger, a second square (the side $2\frac{1}{2}$ inches) can be cut; the flanges

at L M are gummed to this, and then the house is fastened on.

Other easily made farmhouse models are a hen-coop, a barn, a pigsty, the farmhouse itself, etc.

The Noah's Ark (Plate III). As this is a fairly large toy, it is best made from separate pieces of cardboard hinged together by strips of paper. If it is cut from one or two pieces, the size of the cardboard is somewhat unmanageable.

The following Noah's Ark is of a suitable size for holding cork animals.

Two pieces of cardboard are cut, $8\frac{1}{2}$ inches by 4 inches (Fig. 179). Cut two other pieces, $3\frac{1}{2}$ inches by 6 inches. Mark and cut these out as A and C. In one side, A, a door is cut. A paper-fastener is put in to form the handle. On the other sides windows may be drawn and coloured. When fastening the pieces together the children must be very careful that the bend of the hinge is straight.

Fig. 179 shows the pieces of the Noah's Ark hinged together. The children will find it easier if they paste the hinges on A and C

first and let them dry thoroughly; then they can fasten A to B and C to B and D, and lastly D to A, but B must be firmly hinged to A before C is attached, and so on with the other

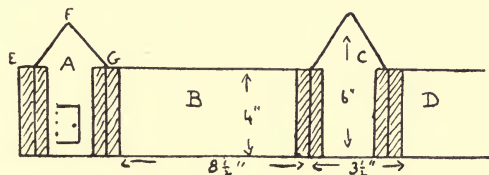

FIG. 179

parts. However, there is plenty of work to be done while the children are waiting for the paste to dry. (In their eagerness to finish toys the children often want to paste or glue too many things together at once.)

For the bottom of the ark a piece of cardboard, $13\frac{1}{2}$ inches by 5 inches, is cut and pointed at each end.

For the roof the children can get the measurements themselves. The long side of the ark is $8\frac{1}{2}$ inches, so that if the roof projects $\frac{1}{2}$ inch on each side of this the length will be $9\frac{1}{2}$ inches. They must measure E F (Fig. 179); this will be about $2\frac{1}{2}$ inches. Now, the roof must cover E F and F G and project about a $\frac{1}{2}$ inch beyond E and G, so that the width of the roof must be 6 inches.

Therefore, they must cut a piece of cardboard $9\frac{1}{2}$ inches by 6 inches. Down the middle of this a half cut is made, along which the cardboard is folded. A stronger method is to cut the roof in half and hinge the two pieces together by a piece of paper cut and coloured to represent tiles; thus the roof will open and shut easily without breaking. The roof can be coloured or covered with blue paper.

When the body of the ark is complete, it must be placed on to the bottom, so that it stands in the middle. Two hinges on each long side will be sufficient to keep the ark steady, but hinges can also be made for the shorter sides. The hinges are more easily put on the outside, but would look neater if fastened inside the ark.

One half of the roof is fastened by paper hinges to three sides of the ark; the other half opens and shuts.

A strip of cardboard, the width of the door, is cut to form a gangway for the animals to enter the ark. Across this matches should be glued.

Very effective animals can be made from corks, as explained in Chapter VII. Easily made animals are the elephant, camel, giraffe, horse and donkey. The children will suggest other possible

animals, *e.g.* a hedgehog, or porcupine, a small cork with pins stuck in it, etc.

Noah and his wife and children can be made from corks. A cork is filed round the narrowest end to form the head (Fig. 180). Eyes, mouth, etc., can be marked in ink. Round Noah is pasted a piece of coloured paper to form a cloak, open in front; this,

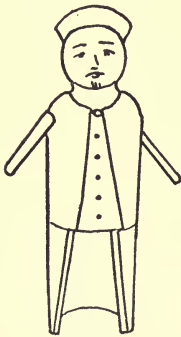

FIG. 180



FIG. 181

with the help of match sticks for legs, enables him to stand. Half matches form the arms. A piece of round paper gummed to the head forms a hat.

Noah's wife (Fig. 181) has a piece of coloured paper round her body to form a skirt, on which she stands.

A Dog Kennel (Fig. 182). This toy is made of either cardboard or stiff paper, on lines similar to those of the Noah's Ark.

The bottom and the sides can be made from one piece, $7\frac{1}{2}$ inches by 4 inches (Fig. 183). Half cuts are made along H A and B C.

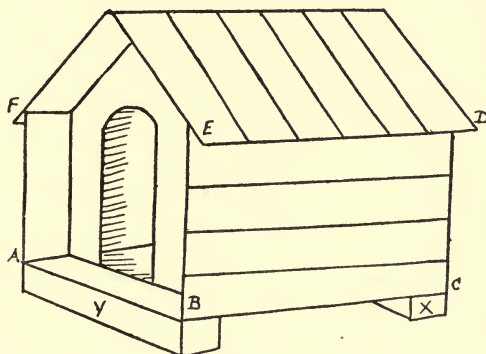

FIG. 182

In fixing the front of the kennel it will be noticed that the bottom and the sides project beyond it. The back portion can be fixed to coincide with the edges of the bottom and sides. The roof can

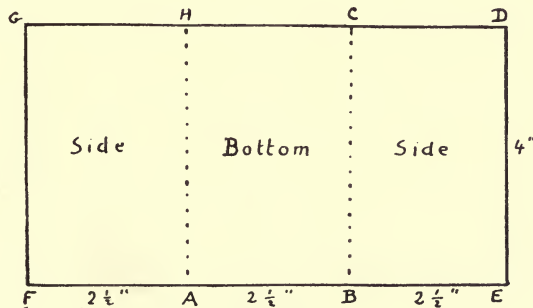

FIG. 183

be measured and fixed as described in the Noah's Ark. Planks can be indicated by drawing lines across the sides and the roof. The kennel may be fastened to two strips of wood, y and x.

A Shop. This can be made like the Noah's Ark, except that the bottom will, of course, be a rectangle, and one long side must be left open. The children can turn cardboard boxes of different kinds into shops quite easily. Perhaps one of the easiest shops to make is the butcher's. The inside can be covered with white

paper, upon which the children have drawn tiles in blue or green pencil. A little paying-desk (Fig. 184) can be made of brown

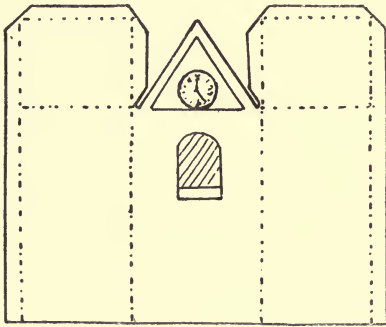

FIG. 184

paper and gummed to one of the walls. Tables can be made of cardboard, or of wood if the children have begun woodwork. Joints of meat drawn on cardboard, and coloured with red pencil, look very realistic when cut out. To hang these the children can hammer nails half way into a piece of stripwood and glue it to the wall. The joints can be attached to the nails by pieces of string.

Other toys that can be made in a similar way from stiff paper or cardboard are castles, houses, a sentry-box.

A Wheelbarrow (Fig. 188). This toy is made of cardboard of medium thickness. Fig. 185 shows how the bottom and the sides are cut out from one piece. Half cuts are made along the dotted lines. Small holes are made at *d* and *c* for the axle of the wheel.

Figs. 186 and 187 show the two ends of the barrow. Before placing them in position a little seccotine should be put round their edges; with the help of this and the slits they will be quite firm.

The wheel is about $\frac{7}{8}$ inches in radius. It is mounted on an axle made of a rounded match stick or piece of cane. Two small pieces of cork can be filed to the shape of *E* and *F* in Fig. 189, and holes made through them. They are then slipped on to the axle on each side of the wheel (Fig. 189) to prevent the latter from wobbling. The legs are made of strips of cardboard about $\frac{1}{4}$ inch wide and $2\frac{1}{2}$ inches long (Fig. 190).

A very slight half cut is made along the dotted line, so that part of the leg, *k*, may be bent straight when *h* is gummed to the side of the wheelbarrow.

Fig. 191 shows another method of making the legs. A half cut is made along the dotted line, *h* is bent back at right angles to *k* and is gummed to the side of the barrow. The

slant of the dotted line is the same as the slant of the sides of A in Fig. 186.

This toy could also be made of three-ply wood with a fret-saw.

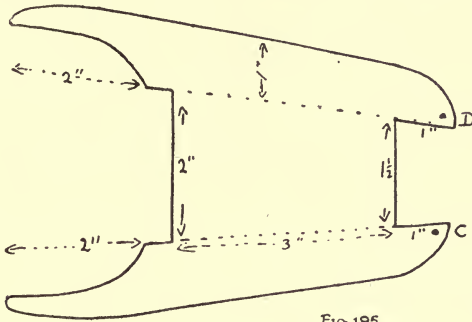

Fig. 185

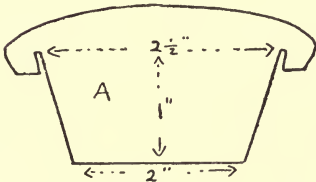

Fig. 186

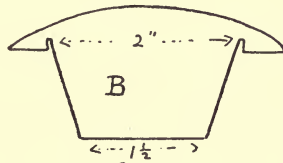

Fig. 187

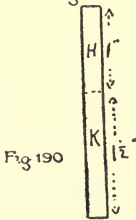

Fig. 190

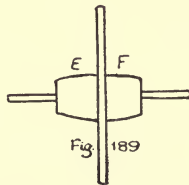

Fig. 189

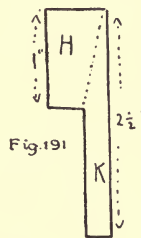

Fig. 191

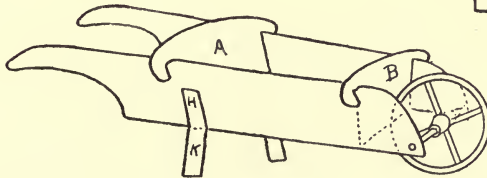

Fig. 188

The sides and bottom would then have to be cut in three separate pieces.

CHAPTER XI

SIMPLE WOODWORK

CHILDREN as young as seven can begin woodwork, but the little strength they possess for sawing makes it necessary to give them prepared wood, called stripwood. There is no need, however, to begin woodwork in too great a hurry, so many are the toys which the children can make with match-boxes, corks, paper and files, and the more familiar the child gets with his ruler and with simple measurements, the better able he is to saw to advantage. Woodwork may well be postponed to the age of eight or nine, then the child can begin to measure accurately and be introduced by degrees to the mysteries of set-squares, try-squares and T-squares.

The following tools are necessary when beginning easy woodwork with children from seven to ten years of age; other tools, described in Part II, can be added as the children advance in age and in ambition:

1. Bench-hooks, against which children can press their strips of wood and hold them firmly. A simple one is shown in Fig. 192.

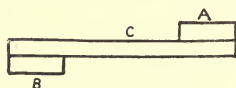

FIG. 192

c is a piece of hard wood about 8 inches square, A is a strip of hard wood against which the child can hold her wood, B is a strip of wood that presses against the table.

2. Try-squares.
3. A brass-back saw with a blade about 6 inches long.
4. A light hammer.
5. Files—these are very cheap. Some must be round; the others should be 8-inch files, $\frac{1}{2}$ cut (one safe edge).
6. Bradawls (or meat skewers).
7. A pair of pincers.

Other materials required will be liquid glue, sand-paper, nails—useful ones are $\frac{3}{4}$ and $\frac{1}{2}$ veneer pins.

With regard to wood, children as young as seven should be given prepared lengths (schools are commonly supplied with the so-called satin walnut, machine-planed, see next chapter), from which they can saw portions for making simple objects, such as picture frames, ladders, gates, objects which consist of different lengths of wood nailed across each other.

A word of advice is necessary with regard to sand-paper; this varies in coarseness from No. 00 to No. 3, every sheet being stamped. It should never be used until all work with edged tools is finished, as the particles of sand left on the surface dull an edged tool. When using sand-paper on a flat surface it should be wrapped round a rectangular block of wood. All corners should be left as sharp as they are left by the edged tools and rarely sand-papered. Lastly, always sand-paper with the grain.

The bradawl varies in size or diameter of the steel shaft from $\frac{1}{16}$ inch to $\frac{1}{8}$ inch or $\frac{3}{16}$ inch. The legitimate purpose of the bradawl is to bore holes in wood so as to ensure the passage of a nail or screw in the right direction, and to facilitate its entrance into the wood.

Three words of advice might be remembered by teachers beginning woodwork :

(1) Don't begin it too soon; don't begin woodwork with children of seven and eight because others do; wait until they are really ready, until they have the necessary strength. There is plenty for them to do in measuring and cutting out paper toys and toys of thin cardboard; they will enjoy the woodwork the more when it comes.

(2) Simple doll's furniture, chairs and tables, are not easy for the child to make.

(3) Leave behind as soon as possible prepared stripwood and its everlasting gates, railings, bridges, picture frames.

Suggestions for Teachers who are beginning Woodwork with their Forms. Let the children measure out and cut a square of wood to support the merry-go-round, make the stand for the swinging boats and great wheel (Chapter XIV). Make the Noah's Ark and dog kennel described in Chapter X.

A very simple toy for beginners is a **Flat-bottomed Boat**. A flat, oblong piece of wood is marked out as in Fig. 193, the bow and stern are cut as indicated; the three dots down the central

100 TOY-MAKING IN SCHOOL AND HOME

line indicate the position of the masts. These can be made of wooden meat skewers or of pieces of stripwood ($\frac{1}{4}'' \times \frac{1}{4}''$) rounded toward the top.

Nails are driven through the bottom of the boat so that they

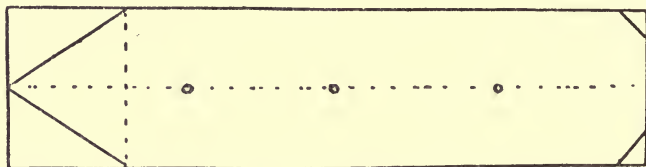

FIG. 193

project about half an inch above the surface ; on to these points the masts are hammered, having first had a little glue applied to the base ; nails are hammered carefully round the sides for railings, with cotton intertwined. Funnels of red paper, little squares of

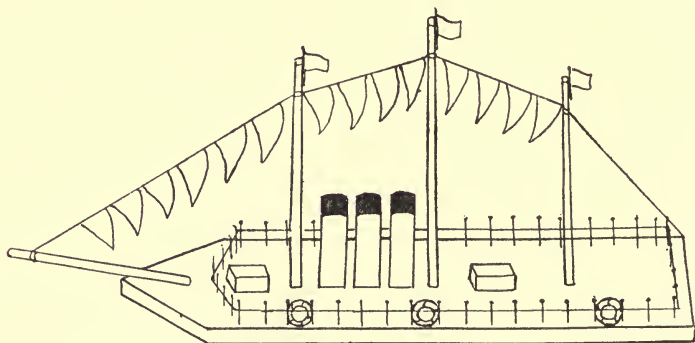

FIG. 194

wood for cabins, paper or cardboard lifebuoys and anchors, a captain's bridge, etc., may be added (see Fig. 194).

Children delight in tying thread from mast to mast (a ridge must be filed round the tops of the masts to keep the cotton from slipping down) and in decorating this thread with flags.

Instead of nails, stripwood ($\frac{1}{4}'' \times \frac{1}{4}''$) may be glued or nailed along the sides, and a piece of wood nailed over the bow (Fig. 195). These boats will float on water if they are not too heavily laden with cabins, etc. Fig. 196 shows a fishing-boat complete.

A reel will be found very useful as an anvil when driving the nails through the bottom of the boat to hold the masts. The child should hold his piece of wood—through which he is driving a nail



FIG. 195

—in such a position that when the point comes through the wood, the nail makes its passage down the hole in the middle of the reel. As soon as the point has been driven through to a certain distance, the child can lift up his wood and examine—and if need be correct—the direction of the nail before fixing on the mast.

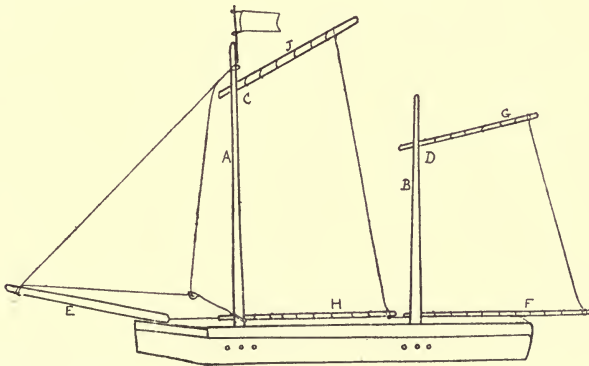

FIG. 196

Hammering must be done with the hammer held with the hand well back from the head, and each blow struck so that the flat face of the hammer falls exactly upon the head of the nail. Gentle but firm blows are necessary; heavy blows are likely to bend the nails. All bent nails should be at once drawn out.

CHAPTER XII

MATERIALS

Nails. The nails used in the making of the toys described in the following chapters are made of very fine wire, with fine points. The wire commonly used for such nails is 17 gauge, but a finer gauge (21) is better for light woodwork, for it does not split the wood so easily. The nails vary in length from $\frac{1}{4}$ inch to 2 inches, increasing by eighths of an inch. The most useful sizes are veneer pins $\frac{1}{2}$ inch in length and $\frac{3}{4}$ inch in length.

Panel pins have small heads.

Liquid Glue. Though this is dearer than ordinary glue (it can be obtained in small bottles, price $4\frac{1}{2}$ d), it is always ready for use, and is not affected by exposure to the air, except that it thickens and hardens from evaporation. If spread thinly over the wood it holds the various pieces firmly together. When fastening different pieces of wood together it is well, whenever possible, both to glue and nail them.

Wood. (1) *Satin walnut* is one of the easiest woods to work, and is adapted for a wide range of work, but it is liable to warp and twist badly unless properly seasoned.

For handwork in school, and for toy-making generally, satin walnut machine-planed can be had in the following useful sizes. They are supplied in lengths of 2 feet and are done up in bundles of 100.

| | | | | | |
|-----|--|-------|---------|-----|---------|
| (a) | $2' \times \frac{1}{4}'' \times \frac{1}{4}''$ | about | 2s. 9d. | per | bundle. |
| (b) | $2' \times \frac{1}{4}'' \times \frac{1}{2}''$ | „ | 3s. | „ | „ |
| (c) | $2' \times \frac{1}{2}'' \times \frac{1}{2}''$ | „ | 3s. 3d. | „ | „ |
| (d) | $2' \times \frac{1}{4}'' \times 1''$ | „ | 4s. | „ | „ |
| | $2' \times \frac{1}{4}'' \times 4''$ | „ | 9s. | „ | „ |

In the toys described in the following chapters satin walnut lengths (a), (b), (c), and (d) are referred to simply as stripwood.

(2) *Round dowel rods* in beech or birch $\frac{3}{16}$ inch to $\frac{7}{8}$ inch diameter

and 36 inches long are useful for axles and for the perches for the swinging animals, etc. These dowel rods cost 3s. to 10s. per 100. Dowels are made by planing up a strip square in section, then planing off the corners, and finally the resulting eight corners. They are now nearly round, and can be made quite so by hammering them through a hole in a piece of hard wood or metal.

(3) *Sawn laths such as builders use* are perhaps the cheapest material that it is possible to get. These can be got from builders' and timber-merchants' yards at a cost of about 9d. to 1s. per bundle of 100. Each lath is 3' 6" × 1" × $\frac{3}{16}$ ".

(4) "*Three-ply*" is composed of three thin layers of wood glued together under pressure. The grain of the centre layer is laid at right angles to that of the other two, so as to give additional strength and to avoid warping. "Three-ply" will not split easily and should be used for the jointed animals and swinging animals described in Chapter XX.

Ply-wood is usually sold in thicknesses varying from $\frac{1}{8}$ inch to $\frac{1}{4}$ inch. Price of three-ply boards in large squares for cutting up :

| | | | | |
|--------------------------|------------|--------------------------------|----|----|
| $\frac{1}{8}$ in. thick, | 47" × 38", | $\frac{3}{4}$ d. per sq. foot. | | |
| $\frac{3}{16}$,, | 53" × 34", | 1d. | ,, | ,, |
| $\frac{1}{4}$,, | 72" × 48", | 1 $\frac{3}{4}$ d. | ,, | ,, |

Match Stales. These are sometimes useful in toy-making, though ordinary matches that have been used generally, serve as well. Match stales may be obtained from Messrs Bryant & May's, Fairfield Works, Bow, E., at 1s. per bundle (about 1500 to the bundle). These are supplied without brimstone, 4 $\frac{5}{8}$ inches long, and thicker than the matches in common use.

Most of the wood so far described is prepared wood (with the exception of builders' laths), and is ready for use at once ; it has merely to be sawn to the right length or the right size. But it is well to get the children away as soon as possible from dependence upon this "prepared material" and to encourage them to use "waste material."

If there is a kitchen or tuck shop in connexion with the school this will supply the children with useful wooden and cardboard boxes of various sizes. The wooden boxes in which Fry's,

Cadbury's, etc., chocolates are packed are most useful in toy-making. The wood is easy to saw and fairly free from knots.

If no school kitchen or tuck shop exists a grocer, for a few pence, will supply a delightful collection of wooden boxes, sweet-boxes, soap-boxes, boxes that have contained bovril, etc. The greater part of every wooden toy in this book has been made from materials such as these.

To avoid expense one should begin at once to collect useful boxes ; this adds to the enjoyment of toy-making. A tobacconist will often give away his cigar-boxes, the wood of which is a pretty brown colour and very useful. Unfortunately, it is sometimes so thin that it is very liable to split. It is difficult, too, to get the paper off some boxes, and the children who resort to washing, scrubbing, and sometimes boiling (!) the wood do not improve it. However, all waste wood has to be prepared in some way ; generally the file and sand-paper will make it ready for use.

Other materials that are invaluable to the toy-maker and should be carefully preserved are old broom handles, reels, and the round rods of various sizes that one often comes across.

Lead plays an important part in many toys ; sheet lead can be bought in pennyworths ; lead buttons can also be bought. Chains are also useful (for example, in Part II, in the drawbridge, the siege tower, etc.), so toy watch chains or any odd pieces should be preserved, as these chains look more effective than those made of wire. Very good chain can be bought from an ironmonger's—price, 3d. a yard.

CHAPTER XIII

SOME DIFFICULTIES IN TOY-MAKING

I. Gluing. Generally when pieces of wood are fastened together, both glue and nails should be used ; the glue prevents the wood from revolving on the nails, and the nails hold when sometimes a sudden jar will cause pieces of wood that are glued to separate. However, if glueing be well done, it will serve well without nailing, and it is often convenient to use glue only when making small toys or when adding a piece of wood to a delicate toy that will not stand the shock of the hammer. To apply glue so that the pieces of wood that it fastens shall hold together permanently, the following points should be borne in mind :

(1) The layer of glue should be so thin that the seam will scarcely be seen.

(2) The glue must be perfectly free from sawdust, shavings, etc., and so must the wood.

(3) Glue must be evenly and thinly applied to *both* the surfaces that are to be joined.

(4) The surfaces to be joined must be perfectly smooth.

(5) Time must be given for the glue to dry. Children often want to touch too soon.

II. Nailing. Generally in nailing holes should first be made for the nail with a fine bradawl or drill. The holes for the nails should be made just large enough to allow them to stand upright in them without being held. The points or heads of nails that project should always be filed away.

III. Sand-papering. A holder for sand-paper should be used, as by simply holding the sheet in the fingers it is impossible to retain the perfect flatness of the surface. A holder can be bought for twopence. Sand-paper should always be applied with a very light pressure, lest it wear away the surface unequally.

IV. Filing. Filing should be resorted to as little as possible. *Avoid filing the saxon edges.* Children often saw carelessly, relying

on the file to remedy defects. The file, however, is useful when cutting discs, to make the circle perfect. Round files are very useful in finishing off round holes and in enlarging them when required. The sharp edges of triangular files can be used for making notches, such as those in the deck-chair (Part II, Chapter III).

V. **The Making of Wheels.** The child toy-maker often finds wheels somewhat of a problem. There are, however, several ways of making or getting them.

(1) Small reels make good wheels for trams, motor-cars or trains. They require no sawing. Fig. 197 shows how they are

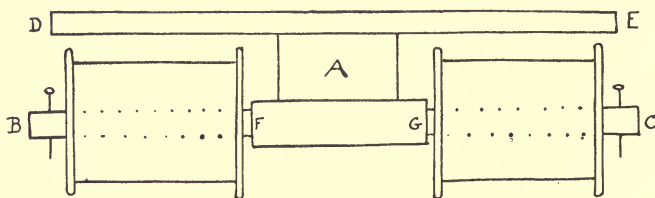

FIG. 197

fastened on. A is a block of wood glued and nailed on to the axle, B C, which is made of stripwood, $\frac{1}{4} \times \frac{1}{4}$ inch, or $\frac{1}{2} \times \frac{1}{4}$ inch; the ends, F B and G C, are rounded so that the reels can revolve easily on them. The bottom of the car is glued to the block. The reels can be placed quite under the bottom of the car, as in diagram, or they can project. For a train the wheels should be placed underneath.

(2) Large reels may be sawn into several thicknesses. These make excellent wheels, but are very difficult to saw even with a mitre block. It is hard to hold them steady and there is some danger of the children sawing their fingers.

(3) Broom handles, round rods, etc., are easily sawn up and make excellent wheels. Holes have to be drilled through them and enlarged with round file for the axle, or a hole the right size can be made at once with the brace and bit. (For use of which see Part II.)

(4) Wheels can be made with the brace and centre-bit. The way for the centre-bit must be prepared by using a small-sized pin-bit. The wood must be laid perfectly flat, the brace and bit

held perfectly perpendicular, only a little pressure applied upon the knob and the crank turned slowly. The boring must be done half way through from each side of the wood, and this will liberate a disc of wood 1 inch in diameter, or $1\frac{1}{4}$ inch, according to the size of the centre-bit.

(5) There is a little instrument sold called a circle-cutter (price, 2s.), designed for cutting small circular pieces of wood from satin walnut board. It is so constructed that it will cut circles of any size up to 5 inches in diameter. This, however, is difficult for children to use.

(6) For large wheels or table-tops a circle can be drawn in a square, the corners sawn off, the obtuse corners sawn off again and then filed perfectly round. This is rather a laborious method, but quite successful. Holes can be made in the centre with a bradawl and enlarged with a round file.

(7) *Cardboard Wheels.* Wheels can be cut out of cardboard with scissors and pen-knife (the latter is necessary only if the spokes are to be cut out). If several cardboard wheels of the same size are gummed together, a wheel strong enough for any toy in this book can be made. The edges can be filed to make them perfectly even. Cardboard washers prevent the wheels from wobbling.

(8) The fret-saw (see Part II) is very useful for making wheels.

(9) The wooden tops of gloy bottles make very good wheels indeed (especially for motor-cars). They are ready for use at once, as they have a hole in the centre. Also the tin tops of Le Page's liquid glue make excellent small wheels; a hole can easily be made in the centre by means of a hammer and a long nail or the pin stopper of a tube of seccotine.

(10) Wheels can be bought. A sheet of four wheels costs a penny. This is the least satisfactory course.

Of the various ways of making wheels described above, the methods best suited to little ones are (1), (3), (6), (7), and (9). The axles should be narrow strips of wood, with the ends rounded. Round rods do not make good axles, because they cannot be fastened securely to the bottom of the vehicle, the nailing being a difficult matter for the children. In fastening the axles to vans, carts, etc., there is no need for block A (Fig. 197); the latter is only

introduced when the wheels have to be under the vehicle ; in other cases the axle can be glued and nailed directly to the bottom.

Colouring the Finished Toy. A well-made toy is beautiful without paint, which is often used merely to hide bad work and give a false appearance of finish. Children generally like the wooden toys, which they have made, uncoloured, until the grown-up person suggests paint.

However, some toys should be coloured ; for example, the swinging animals described in Chapter XX. If the wood has been well sand-papered water-colour paints can be used. Older children can use oil paints or penny tins of enamel. But let the children realize the beauty of plain wood ; the drawbridge in Part II is far more effective in white wood, with the stones marked out in pencil or crayon, than if painted.

CHAPTER XIV

MERRY-GO-ROUND, SWINGING BOATS, AND GREAT WHEEL

A TOY children delight to make is the Merry-go-round (Plate V). It has been made successfully by children from six to twelve. A square piece of stout cardboard (10-inch side) forms the bottom ; this can be covered with brown paper or coloured paper. A reel is glued in the middle. Into this reel

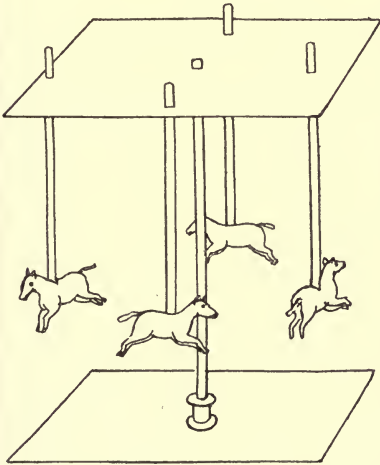

FIG. 198

a stick (about 11 inches long) is fastened securely. Another piece of cardboard is cut round (diameter, 10 inches), and has a reel glued in the middle ; this reel fits on the top of the stick and must turn freely. If the stick is square the top must be rounded to fit the reel. A handle for turning the top can be made from a reel, a piece of cork filed round or a piece of wood. Cork horses, six or eight in number, are made as described in Chapter VII. Paper bands of various colours are gummed round the middle of each horse. These horses are fastened to the top disc by pieces of cane, which may be gummed into the top disc, or simply passed through the holes and bent over.

Paper boys and girls can be cut out to ride on the horses. They will sit on quite steadily if cut out as in Fig. 199. A piece of paper is folded in two along *AB*, and a

reel fits on the top of the stick and must turn freely. If the stick is square the top must be rounded to fit the reel. A handle for turning the top can be made from a reel, a piece of cork filed round or a piece of wood. Cork horses, six or eight in number, are made as described in Chapter VII. Paper bands of various colours are gummed round the middle of each horse. These horses are fastened to the top disc by pieces of cane, which may be gummed into the top disc, or simply passed through the holes and bent over.



FIG. 199

little sailor boy drawn; the figure is cut out, the two halves remaining joined along *c d*. Both sides should be suitably coloured. The figure will be found to have four hands; one raised one on one side, and one lower one on the other, should be cut away. The heads are then gummed together. When placed on horseback the sailor may have his arms folded round the cane. Little girls in sun-bonnets can be cut out in the same way.

Fig. 198 shows a very simple merry-go-round made by a large class, and more suited to the work of a large form than the first one described. Two square pieces of cardboard ($3\frac{1}{2}$ -inch sides) form the top and bottom. Small reels are glued on as in the first merry-go-round. Four pieces of stout cane are pushed into holes in the top piece of cardboard, and the bottom of each piece of cane is split so that it holds a horse cut out of paper.

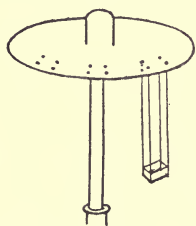

FIG. 200

The children themselves will think of various ways of altering and improving this toy. Fig. 200 shows how match-boxes may be hung round for cars; match-boxes and horses may also be hung alternately. The children delight in decorating the top of their merry-go-round and the stick with coloured paper.

Older children (nine to twelve) like to make the bottom and top of wood; in this case the top may be octagonal in shape. The central pillar, instead of being supported by a reel, can then be fastened as in Fig. 201, by four triangular supports (of which only two are shown).

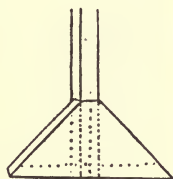

FIG. 201

Swinging Boats (Plate VI). This is another simple and effective toy that little ones can make and play with. The wooden stand can only be made by children of eight and older; a simpler stand can have a cardboard bottom, the supports being reels, the posts stripwood ($\frac{1}{4}'' \times \frac{1}{4}''$), sand-papered to fit reels, and the cross-beam a strip of cardboard with holes in it.

The boats are match-boxes. Four strips of thick paper, all equal in length (a little longer than the match-box), are cut out and gummed inside the box, as *A B, C D*, etc., in Fig. 202. A match

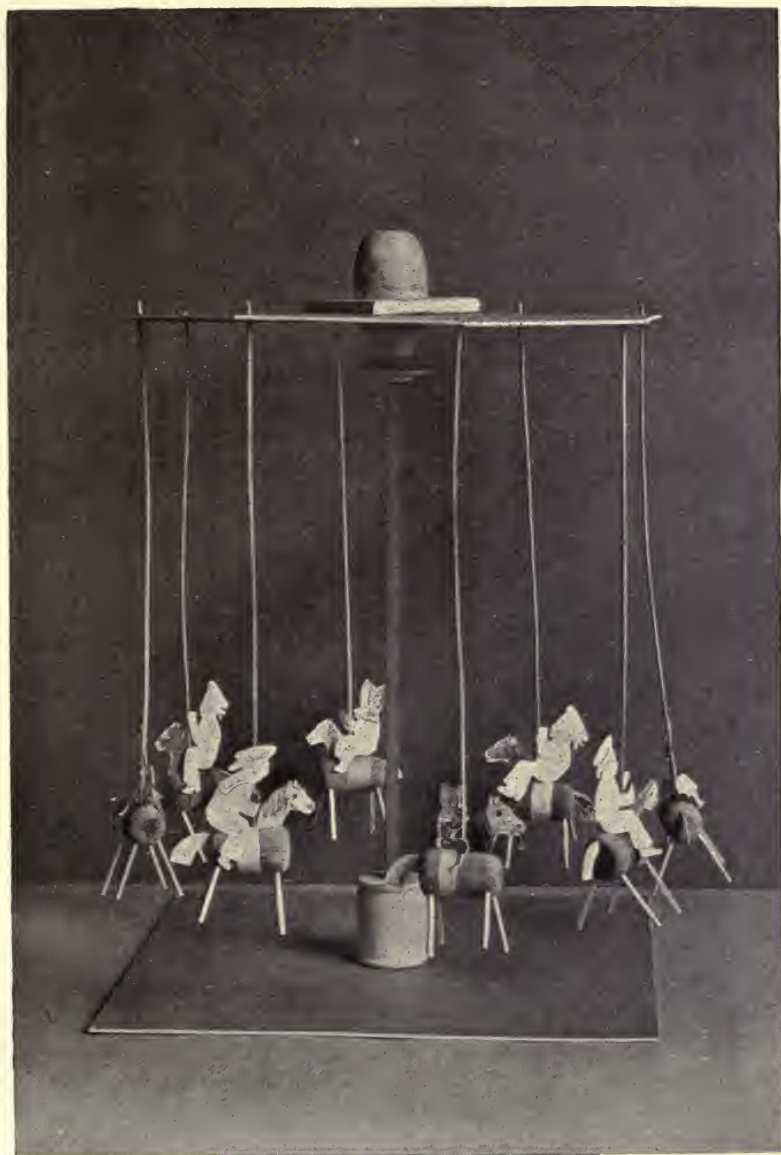

PLATE V

A MERRY-GO-ROUND

stick, H, passes through these strips of paper where they cross and projects on each side. Pieces of thread are tied to each end of the projecting ends. These threads fasten the car to the cross-beam.

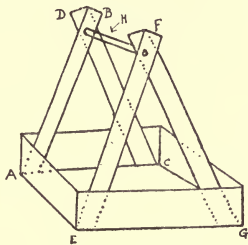

FIG. 202

Paper seats should be put in the box ; it can be covered with coloured paper, and the strips A B, E F, etc., either chalked or covered with coloured paper. The children delight in making and decorating these swinging boats, and then swinging little dolls.

A Great Wheel (Plate VI). Two circular pieces of cardboard are glued to a large reel ; four match sticks are fastened into

holes opposite each other, and to these match-boxes are attached, as explained in the previous toy. A round rod or wooden skewer passes through the reel and through two holes drilled in the wooden supports of the stand. A slight touch will set the wheel spinning. Before putting the wheel together, the sides may be painted.

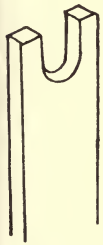

FIG. 203

Fig. 203 shows another possible shape for the top of the supports. This hollow can be quite easily filed out with a round file. Older children might like to make a pulley, as shown in Fig. 204, by means of which the wheel can be turned. The pulley wheels, A and B, are each made of three cardboard circles gummed together, the inner one, in both cases, being of smaller diameter. A is glued to axle F G.

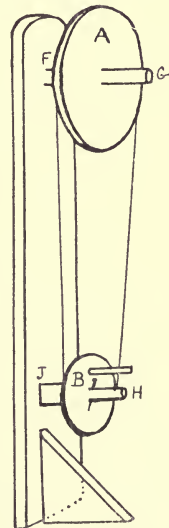

FIG. 204

A is glued to axle F G.

112 TOY-MAKING IN SCHOOL AND HOME

A smaller axle, Ж Н, is fixed into a hole in the support lower down. A hole is made in the wheel, В, into which a match is glued for a handle. В must turn freely on the axle, Ж Н, and is prevented from slipping off by a nail driven through the axle. A small elastic band connects the two wheels.

CHAPTER XV

FLYING AIRSHIPS, GONDOLAS, AND BIRDS (PLATE VI)

THESE toys are made in a somewhat similar manner to the merry-go-round.

Get a large reel (diameter about $1\frac{1}{2}$ inches). Next saw a piece of stripwood, A B, $\frac{1}{4}'' \times \frac{1}{4}'' \times 12\frac{1}{4}''$. Glue and nail to the ends of this cross-pieces of the same stripwood, $4\frac{1}{2}$ inches long. Make holes for nails with a fine drill, otherwise the stripwood may split. Glue and nail A B across the top of the reel as in Fig. 205.

Cut two pieces of stripwood, $\frac{1}{4}'' \times \frac{1}{4}'' \times 6''$. Glue and nail cross-

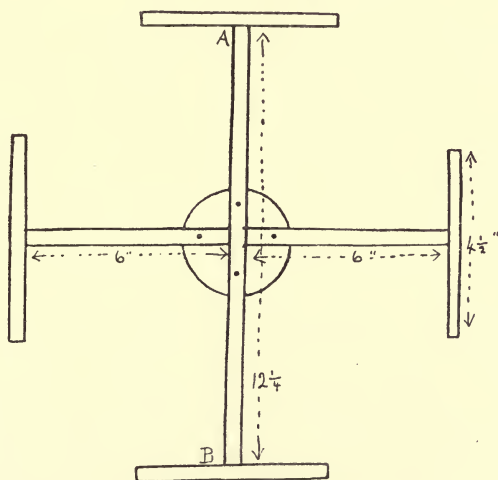

FIG. 205

pieces $4\frac{1}{4}$ inches long to one end of each of these. Glue and nail them to the reel as in figure.

Next glue and nail another large reel to the centre of a board about 4 inches by $5\frac{3}{4}$ inches. Get a dowel rod that will fit the reels (diameter about $\frac{1}{4}$ inch), or file the ends of a square stick to fit ;

this central pillar should be about 13 inches high. Glue this pillar into the reel on the board and fit the other reel with the cross-pieces on the top of the pillar.

The cars must next be made ; they will hang by two strings from the ends of the cross-pieces (Fig. 206). Grooves may be filed

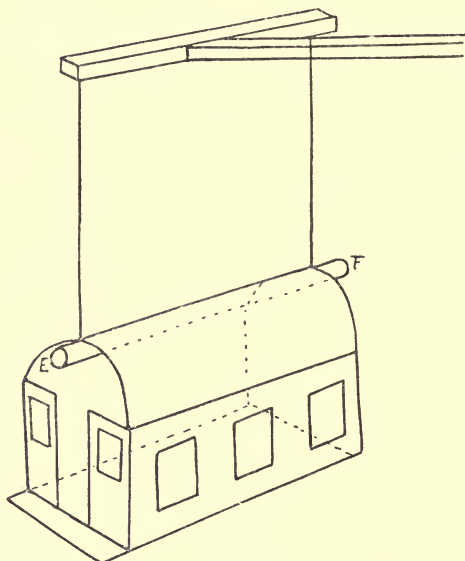

FIG. 206

round the ends of the cross-pieces for tying the cotton, or holes can be drilled in the ends before the cross-pieces are fastened on.

The cars are made of paper, cardboard or wood. Fig. 207 shows the pattern of a car. It should be $4\frac{1}{2}$ inches long and 2 inches wide. The dotted lines show where the paper is to be bent, or in the case of cardboard half cut and bent.

The width of the bottom of the car is 2 inches, the roof $2\frac{3}{4}$ inches ; this allows for bending, and makes a curved roof. The doors can be made to meet if desired ; in this case each door will be 1 inch wide.

Five, four or three windows may be cut in the sides, and windows in the doors.

Paper seats may be fitted inside.

To hang the car a rod is cut, about 5 inches long, E F in Fig. 206,

and grooves are filed at each end. This is glued to the top of the car, with the ends projecting. Pieces of cotton attach the beam E F to the cross-piece. (Length of cotton, about 7 inches.)

A reel may be glued on the top of the arms for turning the airships; cotton may be wound round this, and when pulled causes

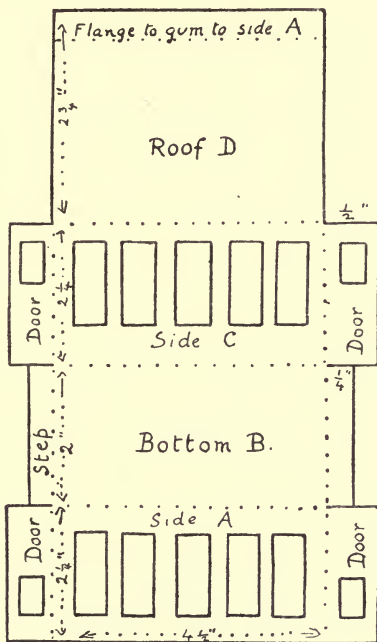

FIG. 207

the cars to revolve. Into the hole of the top reel may be inserted a stick bearing a flag.

Paint the cars according to taste.

When the top reel is set spinning the cars fly round and outward in a delightful manner, gradually returning to a vertical position as the speed lessens.

Gondolas. For the cars gondolas may be substituted, as in Fig. 208. These gondolas form simple and effective paper toys, even if not attached to revolving arms.

Draw on stout paper or cardboard and cut out the two sides, A A, as in Fig. 208. The total length of the boat should be 9 inches.

Next draw a line on a piece of paper, $a' b'$ in Fig. 209, the same length as $a b$ in Fig. 208. Divide the line into three parts at c' and d' . $a' c'$ represents the length $a c$ in Fig. 208; $c' d'$ (not shown to scale), the length of the cabin $c d$. If the full length of the gondola is 9 inches, the length $a b$ will be about $8\frac{1}{2}$ inches, and the length $a c$ should be 3 inches; this makes the length of the cabin,

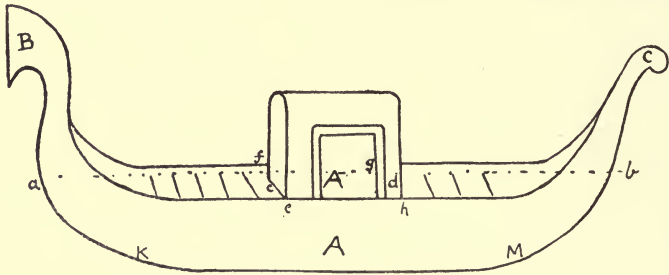

FIG. 208

$c d$, about $1\frac{3}{4}$ inches. Draw two lines at c' and d' at right angles to $a' b'$. Make $e f$ and $g h$ (Fig. 209) equal to the widest part of the gondola. (If the length of 9 inches has been decided on, the width of the gondola should be $1\frac{1}{4}$ inches.) Complete triangles $a' f e$ and $g b' h$ as in Fig. 209; draw flanges as in diagram and cut out. Two other triangles exactly the same size with flanges will be required.

Now fasten together the bows, B, and the sterns, C, of the sides, A A (Fig. 208), with seccotine, taking care that no gum comes below the line $a b$. Gum the triangle $a' f e$ (Fig. 209) to the sides, A A, as

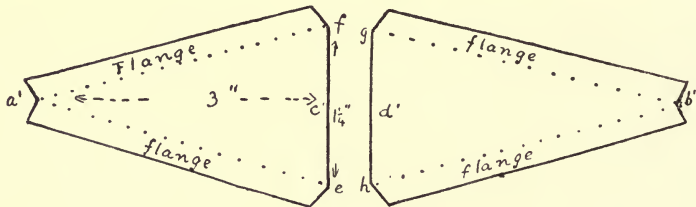
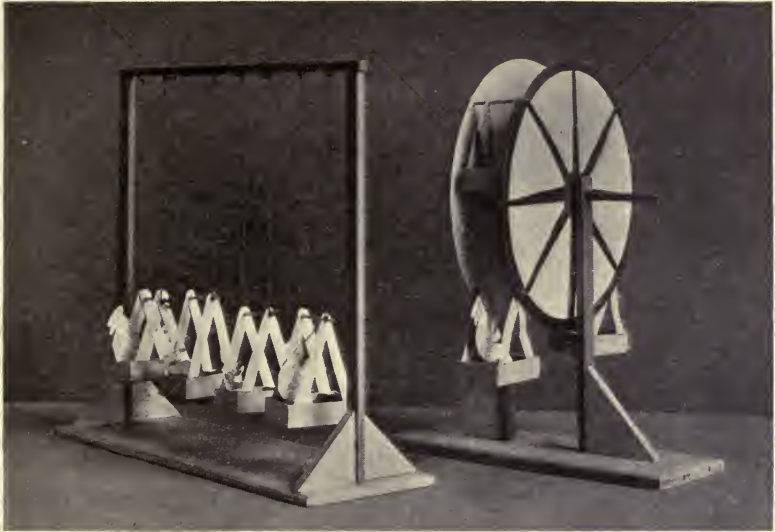
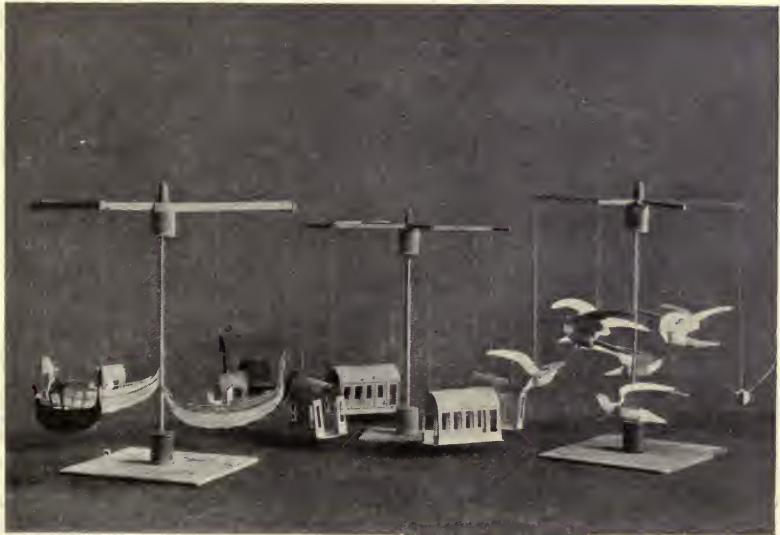

FIG. 209

in Fig. 208. Point a must come at the very end of the sides A, and the surface of $a f e$ forms the deck. Gum triangle $g b' h$ to the sides, A, in the same way (Fig. 208). Now gum the other two triangles to the bottom of the gondola. Their apexes will probably come at



SWINGING BOATS AND GREAT WHEEL,
(Chapter XIV)



about κ and m in Fig. 208. The positions of these points can be determined by finding out at what spot the triangle brings the sides $\Delta \Delta$ closely together; try to keep them as far from ends a and b as possible.

The space left between the two bottom triangles has a piece of paper gummed over it.

Fig. 210 shows the shape of the cabin and the measurements

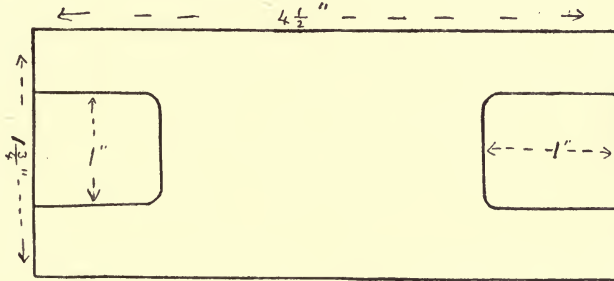

FIG. 210

required for a cabin for a gondola of 9 inches. Four gondolas should be made. They should be painted black and red, or black and yellow, according to taste.

The gondolas are hung from cross-pieces, like the airships, but the arms should be $12\frac{1}{2}$ inches, and the cross-pieces 9 inches; the strings must be of different lengths, since the bow is higher than the stern. Seats may be put in the cabins if desired.

Flying Birds. Cut four arms as for the gondolas (stripwood $\frac{1}{4}'' \times \frac{1}{4}''$ will do), drill small holes at one end, glue and nail them to a reel. Cut four short arms $3\frac{1}{2}$ inches and glue them on between the long arms as in Fig. 211.

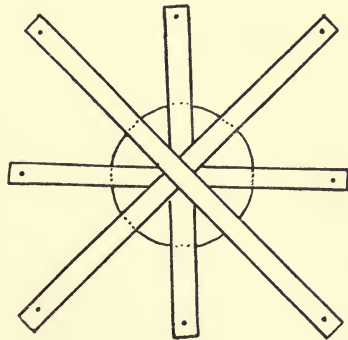

FIG. 211

The birds are made of cardboard and corks. The birds from the long arms should hang low down, and the birds from the short arms higher up. Cane may be used for hanging the birds to the

arms. The outer circle may be hung with sea-gulls (Fig. 212), and the inner circle with swallows (Fig. 213), or all the birds may be

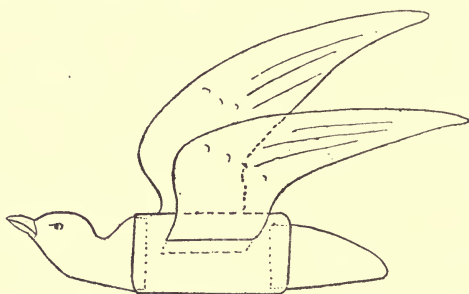

FIG. 212

swallows. When the reel is turned quickly the birds in flight are very effective.

Fig. 212 shows how the sea-gull is made out of a cork and four pieces of cardboard (one for the head, two for the wings, one for the

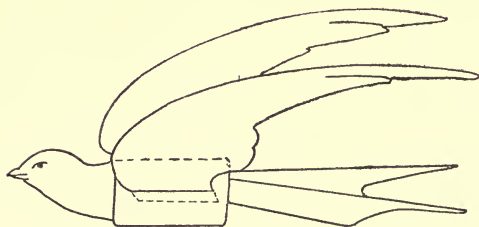
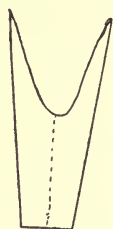

FIG. 213



FIGS. 214, 215

tail). Paint the cork white, paint eyes and a beak, mark a few feathers on the wings. Figs. 213, 214, 215 show how the swallow is made.

CHAPTER XVI

FIRE-ENGINE, MOTOR-LORRY, AND STEAM-ROLLER (PLATE VII)

A Fire-engine (Fig. 216). For this toy two cardboard boxes are required, one about $6'' \times 2'' \times 2''$, A in Fig. 216, and the other, B, $3'' \times 2'' \times 2''$. The cardboard case that contains Le Page's glue is a suitable size for B. Make holes through both sides of A, about 1 inch from one end, for the axle of the large wheels, and holes

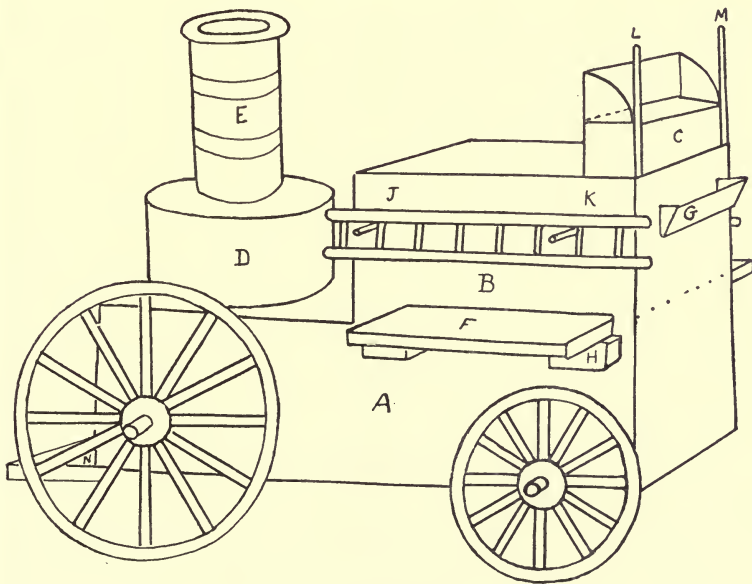

FIG. 216

through B at K and J for the pieces of cane that support the ladders. Gum B to A and cover both with red paper. D is part of a round mantle-box, and the funnel, E, a roll of paper. Both are coloured yellow. F is a piece of stripwood, $\frac{1}{2}$ inch by $\frac{1}{4}$ inch, cut the

right length and glued to B and to two supports, H. A similar piece is fastened on the other side. These are for the firemen to stand on. They may be left their natural colour or coloured grey. The seat, C, is a piece of stripwood, $\frac{1}{2}$ inch by $\frac{1}{2}$ inch, with a paper back, and L M are match sticks glued to the sides. G, the foot-rest, is made of cardboard and fastened to box, B, by two wedge-shaped pieces of wood. The ladders are made of strips of cardboard, with half matches as rungs. N is a piece of cardboard gummed underneath A and projecting from it $\frac{1}{2}$ inch for the fireman's stand. This stand, seat, foot-rest, ladders, etc., should be coloured red. The small wheel is about 2 inches in diameter. The diameter of the large wheel can be measured when the smaller wheels are in position.

A Motor-lorry (Fig. 217). The foundation is a piece of stout cardboard or wood. A is an open box gummed to this, and covered with paper, suitably coloured. B is part of a box cut as in figure and gummed to A. Inside B a wooden seat, D, is fixed. C is a

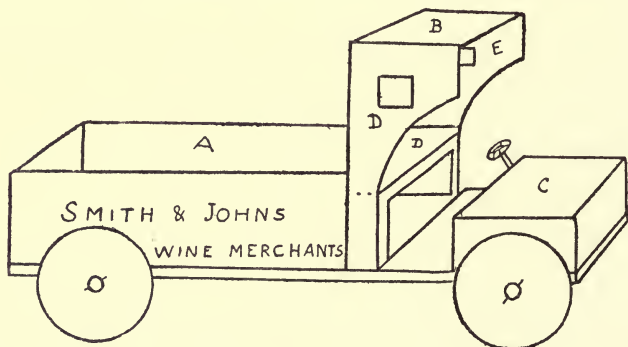

FIG. 217

smaller box, gummed upside down. The size of the lorry will depend upon the boxes procurable. It can also be made of wood, in which case the windows, D and E, and the curved portion of B can be cut out with a fret-saw (see Part II). Both this toy and the fire-engine look very effective made of wood.

A Steam-roller (Fig. 218). Fig. 219 shows the foundation of the steam-roller. A B, C D, etc., are pieces of stripwood, $\frac{1}{4}$ inch by $\frac{1}{4}$ inch. The front roller is made of a small mantle-box about $2\frac{5}{8}$ inches in length. The cover is glued on, holes are made at each end and a

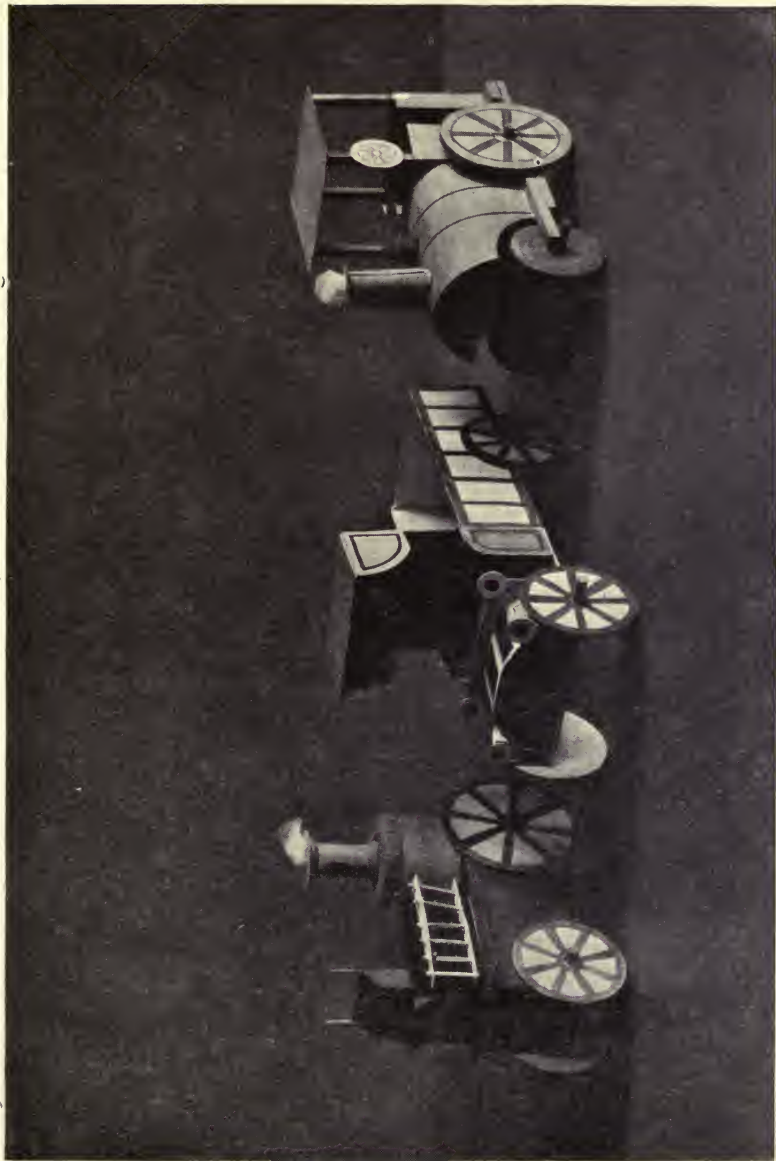

PLATE VII

FIRE-ENGINE, MOTOR-LORRY AND STEAM-ROLLER

round, wooden axle passed through. The ends of the axle should be filed flat as in Fig. 220, so that A and c (Fig. 219) can be glued to them. The roller may be painted black. Cut a piece of cardboard, $6\frac{1}{2}$ inches by $4\frac{1}{4}$ inches. Bend this round so that it fits

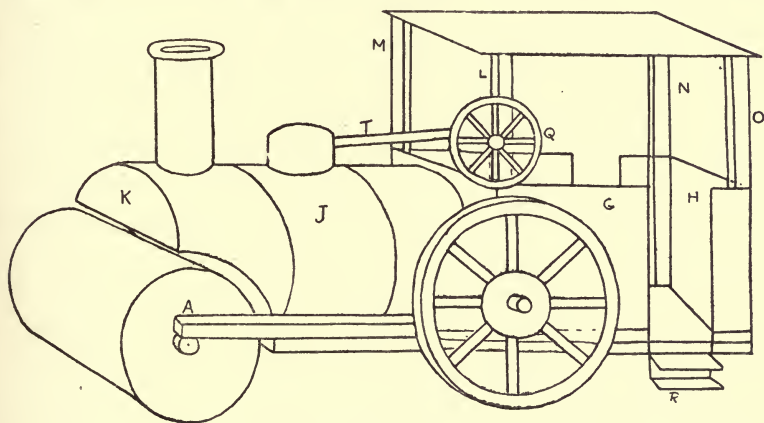

FIG. 218

between A B and C D (Fig. 219); place the roller in position, mark with pencil the portions of cardboard that cover the roller and cut these off (see the shaded parts in Fig. 221).

Fig. 222 shows the construction from cardboard of the part of the cab marked G in Fig. 218. Half cuts are made along the dotted lines; the axle of the side wheels passes through the openings x and y.

Fig. 223 shows the part of the cab marked H in Fig. 218.

Next cut a strip of wood, $4\frac{1}{4}'' \times \frac{1}{4}'' \times \frac{1}{4}''$, for an axle for the side wheels, and round the ends; the wheels are 3 inches in diameter. Fasten these to the axle. Now glue the ends of the axle for the front roller to A and c. While this is drying colour the cardboard parts of the engine dark green. Bend J (Fig. 221) and glue this part to the inner sides of A B and C D. Cover the part marked K (Fig. 218) with paper; the part underneath K may remain uncovered. Glue the axle of the side wheels in position behind J, with just sufficient space for G to slip in between the engine and the axle. When the axle is secure glue G and H in position; G is glued to the inner sides of D C and B A, H is glued to the inner sides of blocks E and F.

122 TOY-MAKING IN SCHOOL AND HOME

The supports, o and n (Fig. 218), are $4\frac{1}{2}'' \times \frac{1}{4}'' \times \frac{1}{4}''$.

m and l are $4\frac{1}{4}'' \times \frac{1}{4}'' \times \frac{1}{4}''$. These supports are $\frac{1}{4}$ inch shorter, as they stand on the axle of the side wheels. The roof is of card-

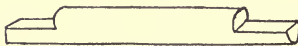
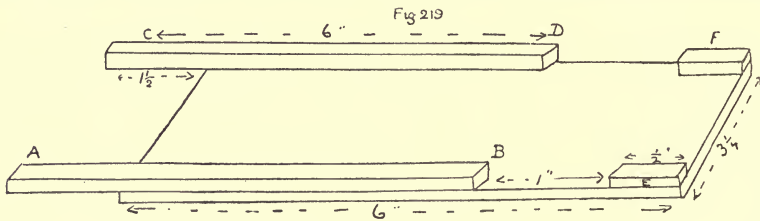

Fig 220

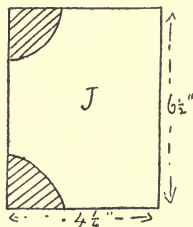

Fig 221

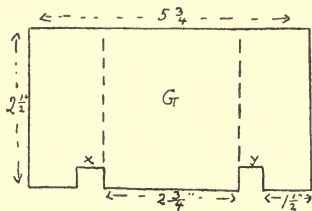

Fig 222

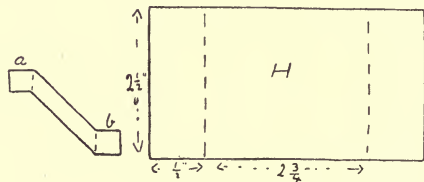

Fig 223

board coloured green. q is a cardboard wheel glued to l, and joined to the dome by a strip of cardboard, t, bent as in Fig. 223. a is inserted into a slit in the cork, and b is gummed to the wheel. The steps, r, are made of stiff paper. The funnel and the dome are made of corks.

CHAPTER XVII

GIPSY CARAVAN AND BATHING MACHINE

THE foundation of the **Caravan** is a piece of wood or cardboard, $6\frac{3}{4}$ inches by 4 inches. The sides are made of stiff paper or cardboard. For each of the long sides draw a rectangle, 6 inches by $4\frac{1}{2}$ inches, and to each side add $\frac{1}{2}$ -inch flanges. Make the two ends as follows :

Draw **E F** (Fig. 225) 4 inches, mark off **E K** and **F L** $\frac{1}{2}$ inch each ; erect perpendiculars **K O** and **L P** ; with **E** as centre and radius,

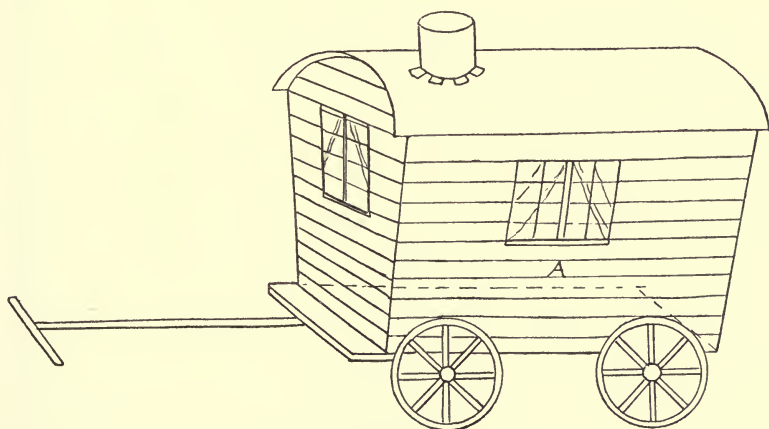

FIG. 224

$4\frac{1}{2}$ inches (*i.e.* height of side **A** in Fig. 224) cut **K O** at **G**, find point **H** in the same way, join **G E** and **H F**. Find **M**, the centre of **E F** ; with **M** as centre and radius **M G** describe an arc from **G** to **H**. Mark flanges along the top, **G H**, to which the roof can be gummed, and a flange at the bottom. In front and at the sides draw and colour the windows, which may be made to open. At the back cut out a door (Fig. 226). Colour the sides a light brown.

124 TOY-MAKING IN SCHOOL AND HOME

Fasten up the caravan by the flanges; the base projects $\frac{3}{4}$ inch at the front.

The roof is made of brown paper and should be cut to project

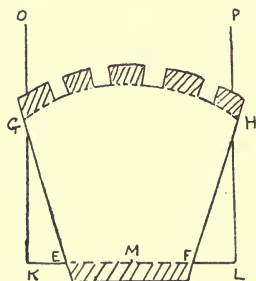

Fig 225

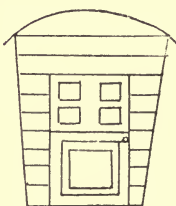

Fig 226

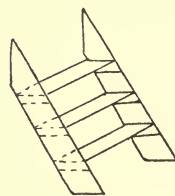

Fig. 227

about $\frac{1}{4}$ inch over the sides and end of the caravan. It is then gummed to the flanges. The chimney is a roll of brown paper.

The wheels should be at least 2 inches in diameter. Steps can be made of cardboard and paper, as in Fig. 227.

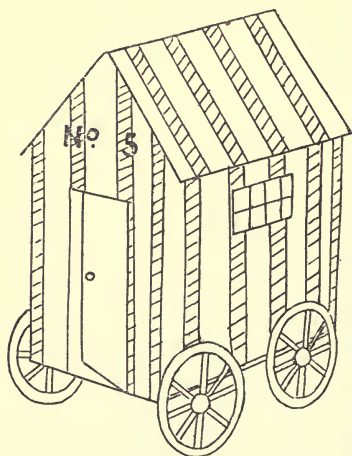

FIG. 228

A Bathing Machine (Fig. 228). This is similar to the Noah's Ark. The measurements are as follows: Base, 4 inches by 3 inches; sides, 4 inches by $4\frac{1}{2}$ inches. Measurements for the ends are given in Fig. 229. The roof should be cut to project about $\frac{1}{4}$ inch over the sides and

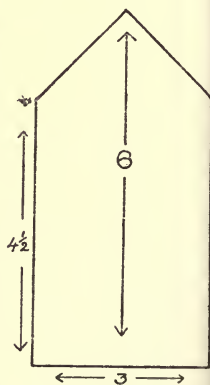

FIG. 229

of the machine. Cut a door in one end. Paint the machine in red and white stripes, mark the windows on each side and a number in front.

The wheels should be about $1\frac{1}{2}$ inches in diameter. Steps may be added.

CHAPTER XVIII

A TRAIN AND RAILWAY STATION (PLATE VIII)

A Train. (1) *The Engine* (Fig. 230). The body of the engine, A, is a long mantle-box or a piece of old curtain pole, about $4\frac{1}{2}$ inches long. The wooden bottom, B C, is $6\frac{1}{2}$ inches by $2\frac{1}{4}$ inches. A is glued to B C and kept in position by wooden blocks, E and F. The funnel and the dome are made from corks or pieces of round wood; their ends must be slightly concave, so that they may fit securely to A. A ring of cardboard is gummed to the top of the funnel, which may

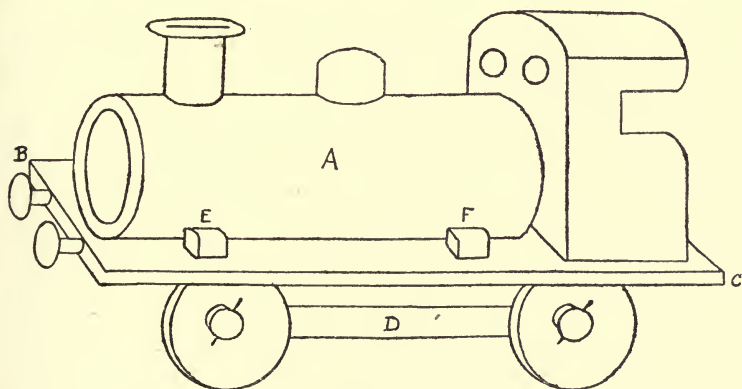

FIG. 230

have a hole in it to take a piece of cotton-wool for smoke. The rim of the funnel and the dome are coloured yellow. The boiler can be covered with dark green or dark red paper. The buffers are pieces of round rod, to which cardboard discs are gummed.

The cab is made of cardboard, as shown in Fig. 231, and is coloured to match the engine. G K L M is gummed to the back of A (Fig. 230), and its sides are fastened to the footplate by the flanges.

Fig. 232 shows the roof of the cab ; the length, NO , is equal to the arc, GHK .

The wheels should be about $1\frac{1}{2}$ inches in diameter and are fastened underneath BC , as described in Chapter XIII. Strips of

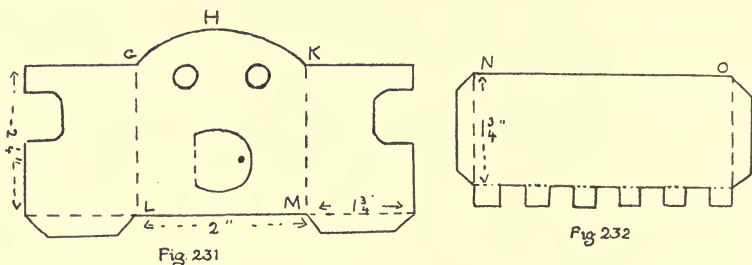

cardboard, coloured black (D in Fig. 230), are glued to the wooden blocks behind the wheels.

(2) *The Tender* (Fig. 233) can be made in various ways. The bottom is best made of wood, 4 inches by $2\frac{1}{4}$ inches. The sides may be made of wood, 4 inches by $1\frac{1}{2}$ inches; the back must be cut to fit exactly between the sides. When the back and the sides are

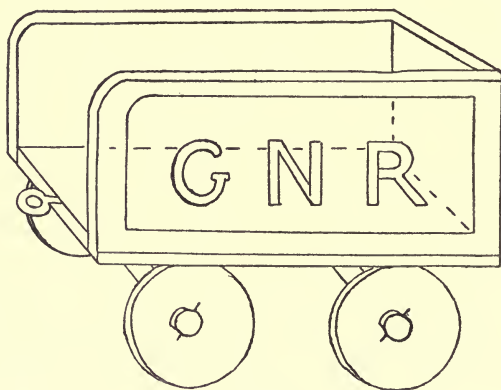

FIG. 233

glued in position two wedge-shaped blocks may be glued into the corners for strength. The buffers and the wheels as in the engine.

The sides of the tender may also be cut out of one piece of cardboard and fastened to the bottom by flanges. It should be coloured to match the engine. Pieces of cork dipped in ink make realistic coal.

(3) *A Cattle Truck* (Fig. 234). The foundation is a piece of wood, 4 inches by $2\frac{1}{4}$ inches. The sides may be cut from one piece

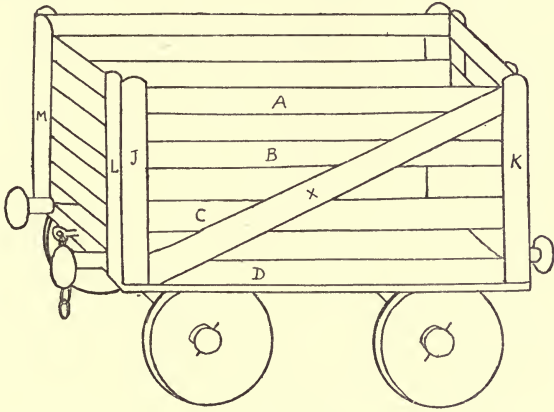

FIG. 234

of cardboard (Fig. 235) and coloured to represent bars, as in Fig. 234. It may also be made of wood as follows: Cut eight thin

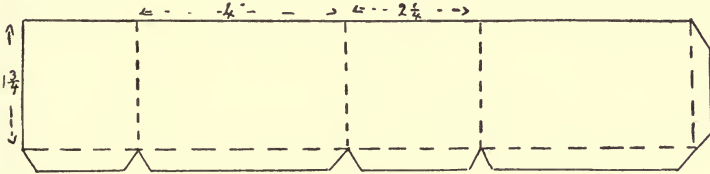

FIG. 235

strips of wood, $4\frac{1}{2}$ inches by $\frac{1}{4}$ inch, A B C D, etc., and eight pieces $1\frac{3}{4}$ inches by $\frac{1}{4}$, J K L M in Fig. 234. The pieces are glued together

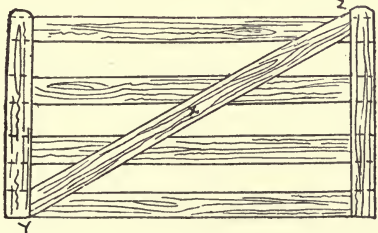

FIG. 236

to form the sides, as in Fig. 236. The length of the cross-bar, x, can be obtained by measuring the distance between y and z.

Glue the sides to the bottom and to each other. Wedges may be glued in the corners for strength.

(4) *A Carriage* (Fig. 237). The bottom is of wood, $4\frac{1}{2}$ inches by $2\frac{1}{4}$ inches. The carriage is made of cardboard, on the same principle as the cattle truck, according to the measurements given in Fig. 237. The upper part of the door may be cut out

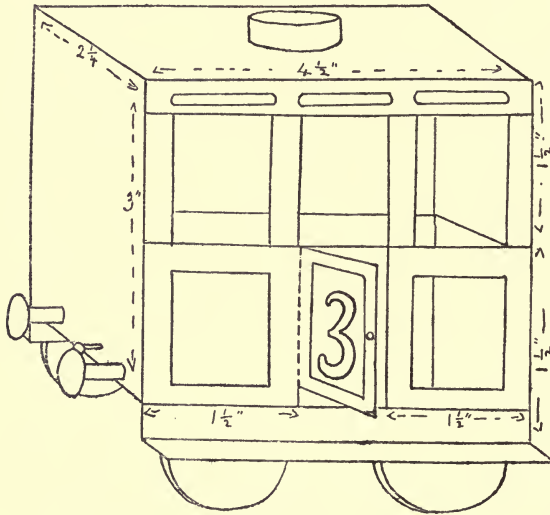

FIG. 237

and the lower part be made to open. The windows may be cut out or coloured with light blue pencil. The interior should be coloured or covered with paper to represent upholstery, etc. Before fastening the cardboard to the bottom, glue to the corners of the bottom small blocks of wood, 1 inch high, as supports for the cardboard seats, which should be gummed across them and be suitably coloured. Cut the cardboard for the top and leave flanges for fastening it to the ends of the carriage. The top and the ends are coloured black or dark brown. A little piece of round wood or cork, coloured black, is gummed to the top for a lamp. The step is made of stiff brown paper. Small screw eyes are screwed in the ends of the various parts of the train, which can be linked together by wire loops.

A Railway Station. This station is a suitable size for the train already described.

A (Fig. 238) is a piece of wood or cardboard, about 2 feet by 8 inches, standing on supports made of two match-boxes gummed together. **B** and **C** are pieces of cardboard fastened by flanges to **A**. **D** is a piece of cardboard gummed to supports **E** and **F** to cover the

and the lower part be made to open. The windows may be cut out or coloured with light blue pencil. The interior should be coloured or covered with paper to represent upholstery, etc. Before fastening the cardboard to the bottom, glue to the corners of the bottom small blocks of wood, 1 inch high, as supports for the



TRAIN AND STATION, SIGNAL-BOX AND SIGNAL,
(Part II, Chapter XII)



PLATE VIII

RED CROSS MOTOR AND TAXI-CABS
(Chapter XIX and Part II, Chapter III)

hollow in front ; this and the platform may be suitably coloured. The railings are of cardboard and are fastened to a piece similar

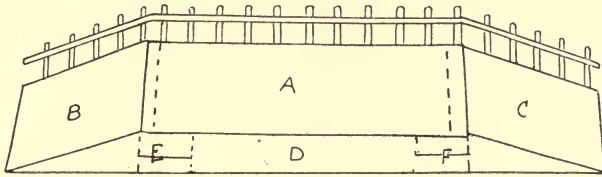

FIG. 238

to D. Advertisements may be cut from papers and fastened to the posts behind the railings ; also the name of the station in the same way (see Plate VIII).

The Ticket-Office and Waiting-Room is shown in Fig. 239. This may be made from a cardboard box of suitable size, or from cardboard (according to the measurements given). The bar before the ticket-office is made of match sticks. Tram tickets form good advertisements for the walls.

Additions to station :

(1) Porter's truck. See Chapter V.

(2) Milk-cans. Corks covered with silver paper. See Chapter V.

(3) Flower-pots. A cork filed the right shape and painted is used. The shrubs are cut out of cardboard, coloured and fastened into a slit in the cork (Fig. 240).

(4) Lamp-posts (Fig. 241). A piece of round rod is placed in a reel or a cork to make it stand. The lamp is cut out of stiff paper, coloured as in the diagram, and is inserted in a slit at the top of the rod. A small piece of cane is passed through a hole near the top for the cross bar.

(5) Benches and seats of various kinds may be made from cardboard.

(6) Figures of men, women, etc., may be cut from illustrated papers and a strip of cardboard gummed behind them to make them stand upright.

(7) Small boxes of various kinds may be placed on the platform for luggage.

In country districts, where the station buildings are of a

130 TOY-MAKING IN SCHOOL AND HOME

simple design, the children may be encouraged to make sketches of these, and to bring to the models described above such

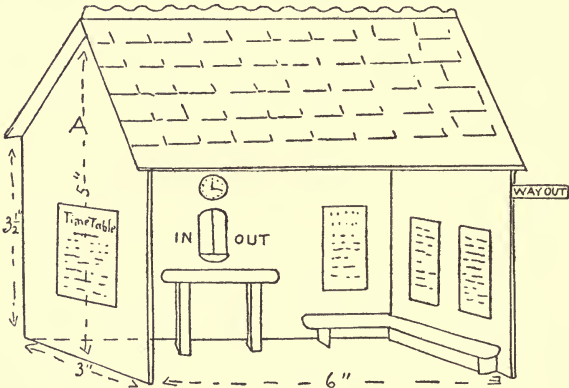

Fig. 239



Fig. 240

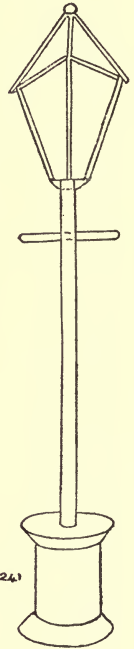

Fig. 241

modifications as are to be found in their own locality. In Part II (Chapter XII) models of working signals and a signal-box are described.

CHAPTER XIX

RED CROSS MOTOR AND TAXI-CAB (PLATE VIII)

Red Cross Motor. Begin with a piece of wood $6\frac{1}{2}'' \times 4'' \times \frac{1}{8}''$. Glue and nail to this two pieces of stripwood, $\frac{1}{2}'' \times \frac{1}{4}'' \times 4\frac{1}{4}''$, A B and c D in Fig. 242.

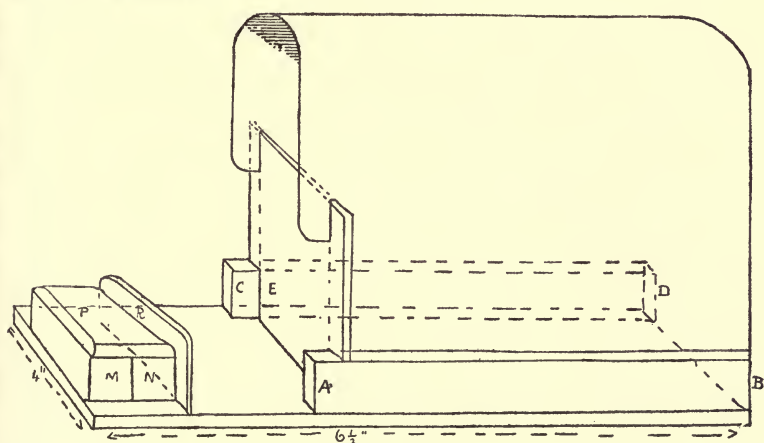

FIG. 242

Next cut out a piece of wood 4 inches by 2 inches (a piece of

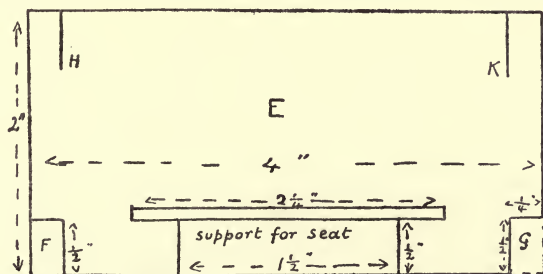

FIG. 243

cigar-box will do for this, or a piece of stout cardboard)—E in Figs. 242 and 243.

132 TOY-MAKING IN SCHOOL AND HOME

Saw out the corners *F* and *G*, so that the piece of wood *E* will fit between the strips *C D* and *A B*. Saw slits at *H* and *K* to hold the cardboard hood. Glue *E* in position as in Fig. 242. A seat must be placed in front of *E*; it should measure about $2\frac{1}{4}$ inches by $\frac{5}{8}$ inch, and may be glued to a piece of stripwood, $\frac{1}{2} \times \frac{1}{4} \times 1\frac{1}{2}$, which is glued to *E* as in Fig. 243.

The bonnet is made of two pieces of stripwood, *M* and *N*, $\frac{1}{2} \times \frac{1}{2} \times 2\frac{1}{2}$; these are glued together and glued on as in Fig. 242.

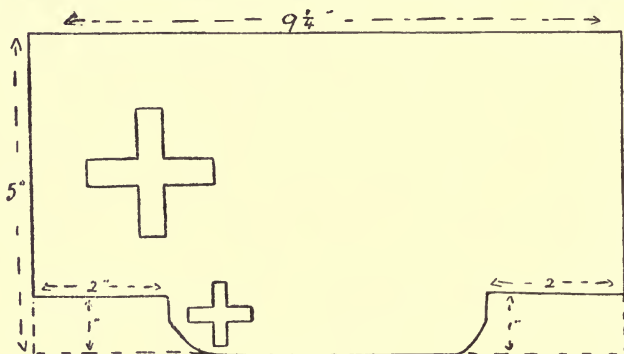

FIG. 244

A piece of wood, *P*, well smoothed and with edges rounded, is glued over *M* and *N*. *R* is a piece of wood 4 inches by 1 inch, with

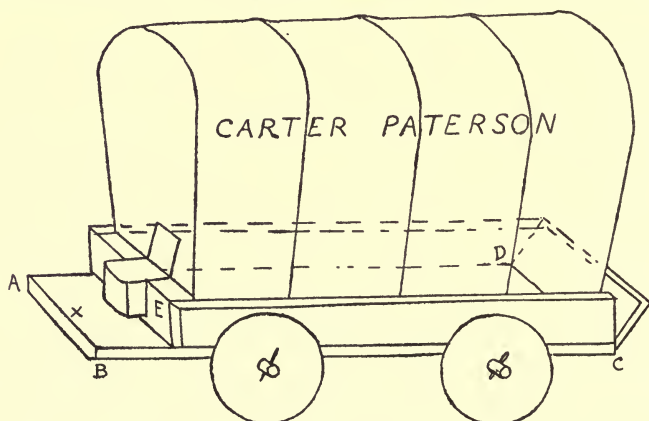

FIG. 245

the corners cut off or rounded. The hood is made of a piece of thin cardboard, 5 inches by $9\frac{1}{4}$ inches, cut as in Fig. 244.

This hood may be painted grey or khaki-colour, and a cross painted in red on the sides, or cut out of red paper and gummed on.

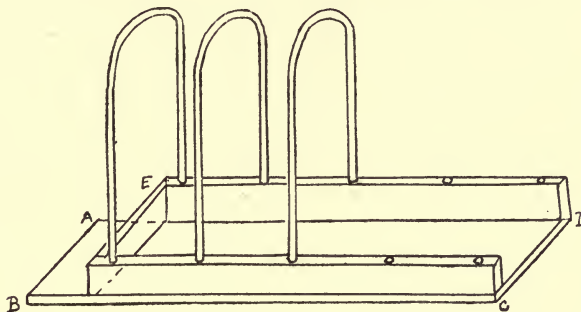

FIG. 246

The hood is glued inside the strips of wood A B and C D in Fig. 242, and fits into the slits H and K in E.

For axles and wheels see Chapter XIII.

Figs. 245 and 246 show another kind of van, made of cane and brown linen.

A Taxi-cab. Begin with a piece of wood, 6 inches by 3 inches. Cut out two pieces of cardboard (medium thickness), $2\frac{1}{2}$ inches by $2\frac{1}{2}$ inches. Draw doors on them and cut out as in Fig. 247. These pieces are painted the colour desired for the taxicab.

Cut out a piece of wood, $2\frac{1}{2}$ inches by 3 inches, for the back, A B. Cut two blocks of stripwood, $\frac{1}{2} \times \frac{1}{2} \times 1$ " (c in Fig. 248), to be glued on to the bottom to support the seat and back, A B. When glueing these blocks in position see that they are about $\frac{1}{8}$ inch from the end, and not quite close to the edges. If additional strength is required these blocks may be nailed as well as glued; the back, A B, is nailed and glued to these blocks.

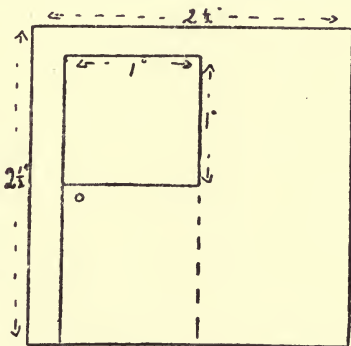
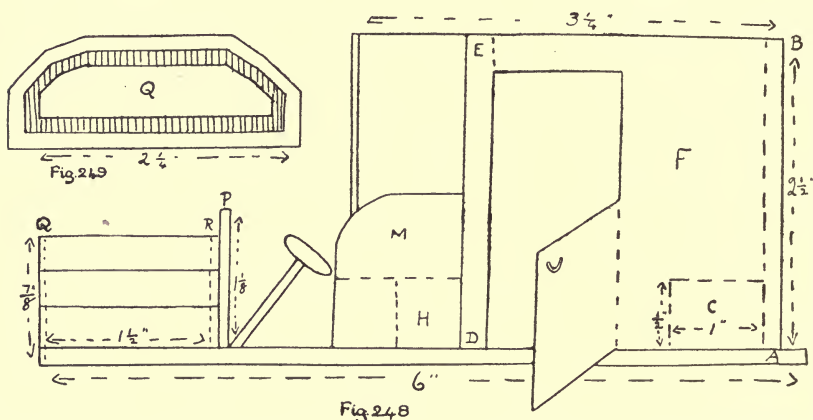

FIG. 247

Now cut two pieces of stripwood, $\frac{1}{4} \times \frac{1}{4} \times 2\frac{1}{2}$ ". Glue these posts $2\frac{1}{2}$ inches from the back, A B (D E in Fig. 248).

Now glue on the sides. Side F is glued to post D E, to block C and to back A B; the other side is glued in the same way. A



cardboard seat may be glued across the blocks and painted the colour desired for the interior.

Now to make the front of the cab. Cut a piece of cardboard of medium thickness, $2\frac{1}{2}$ inches by 3 inches, G in Fig. 250. Draw and cut out the windows (the shaded portion of Fig. 250). To the bottom of G glue a piece of stripwood, H, $\frac{1}{2}$ inch by $\frac{1}{2}$ inch, leaving a strip of cardboard $\frac{1}{8}$ inch wide on each side. H is for the driver's seat. Now glue the front, G, to the posts E D (Fig. 248), and the block H to the bottom.

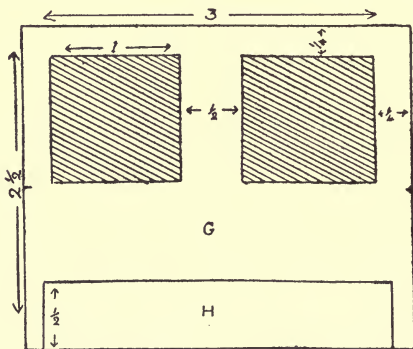

FIG. 250

Two cardboard seats, cut as in Fig. 251, should next be fastened by paper hinges to the inside of G.

To make the top of the cab cut a piece of cardboard, $4\frac{1}{2}$ inches by 3 inches (Fig. 252). Make a half cut along *a b* and bend. Glue portion K to the back of the car A B, and L to the tops of the posts E D and to the sides F. If necessary a paper hinge can be used to fasten the top L to the front G.

A cardboard seat about 1 inch wide is glued to the block H for the driver. The sides of this seat (M in Fig. 248) are made of pieces of wood, $1\frac{1}{2}'' \times 1'' \times \frac{1}{8}''$, one corner being rounded as in the figure, and they are glued to each side of the block H. Two pieces of cane should be glued on each side and to the roof.

To make the bonnet, first cut the piece of wood P, 3 inches by $1\frac{1}{8}''$ inches (Fig. 253). Two round cardboard discs, R and S, with

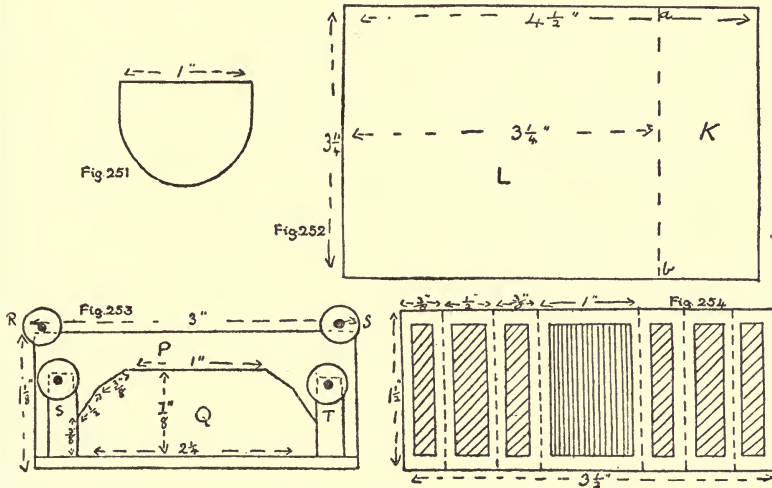

centres painted red are glued at each corner. Next two pieces of wood the shape of Q in Figs. 249 and 253 are cut out. One piece, R, is glued to P, and P is glued to the bottom $1\frac{1}{2}''$ inches from the front (see Fig. 248). The other piece, Q, is glued in front. A piece of cardboard, $1\frac{1}{2}''$ inches by $3\frac{1}{2}''$ inches, is cut as in Fig. 254; half cuts are made along the dotted lines. It is painted as in the diagram. This piece of cardboard is bent along the dotted lines and glued round Q and R to form the bonnet.

Two pieces of wood, $\frac{1}{4}'' \times \frac{1}{4}'' \times \frac{3}{4}''$ (S and T in Fig. 253) are glued in front on each side of the bonnet; these have round pieces of cardboard gummed to them to represent lanterns.

A number should be glued behind and in front of the car and a steering wheel added.

The wheels may be made of wood or cardboard; diameter about 2 inches (see Chapter XIII).

CHAPTER XX

SWINGING AND JOINTED ANIMALS (PLATE IX)

THE peacock, monkey, and other animals with long tails can be cut from cardboard, and by means of lead buttons attached to their tails be made to swing realistically on a perch.

It is difficult in some animals to get the balance correct and the position natural. If the drawings in this book are carefully enlarged and the lead buttons placed on the spot (A) indicated, they will be found to produce satisfactory animals. They look most effective and move more readily when made from three-ply wood with the fret-saw (see Part II), but this work is beyond the ten-year-old child. Children of ten and younger can, however, make them quite well of cardboard (the thicker the cardboard, providing the children can cut it with scissors, the better).

A set made of wood by the teacher will form a delightful plaything for very little ones, and even material for nature lessons.

The **Mouse** (Fig. 259) should be drawn on cardboard, cut out, and both sides coloured. If grey cardboard is used, eyes, whiskers, etc., can be drawn in sepia. Two lead buttons (about the size of half-pennies) are glued one on each side of the tail (at A); pieces of paper should then be glued over the buttons and painted to match the tail.

Children will find it easier to draw these animals if a piece of cardboard is given them on which the animal to be drawn will just fit. The colouring should be as simple as possible to be effective. The stand is similar to that for the swinging boats, but with a rounded bar, on which the part of the animal marked B will rest.

The **Cat** (Fig. 256), enlarged, made more fierce-looking and with stripes painted on it makes a very terrifying tiger, ready to spring.

The **Monkey** (Fig. 265) may have another monkey swinging from his tail, and so on.

Animals with movable limbs can also be cut from three-ply wood (see Part II) or cardboard. If cut from cardboard the various joints are fastened by small paper-fasteners.

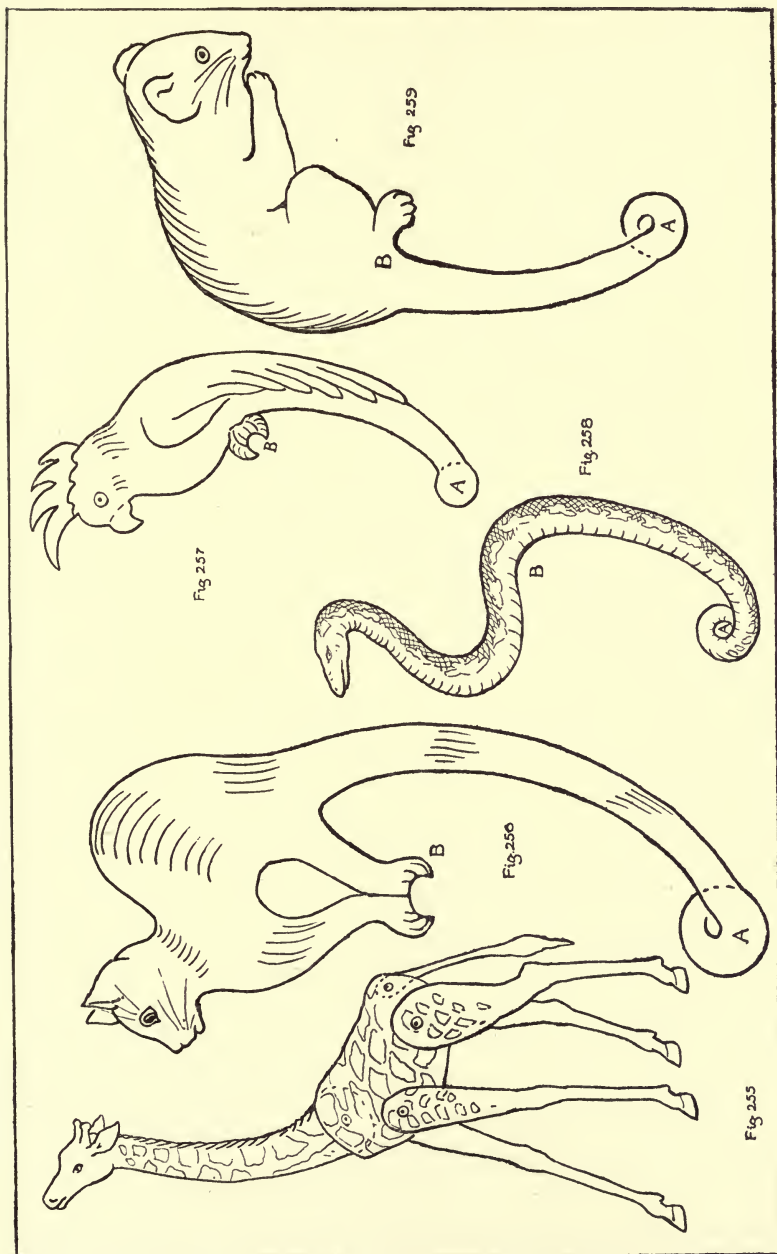

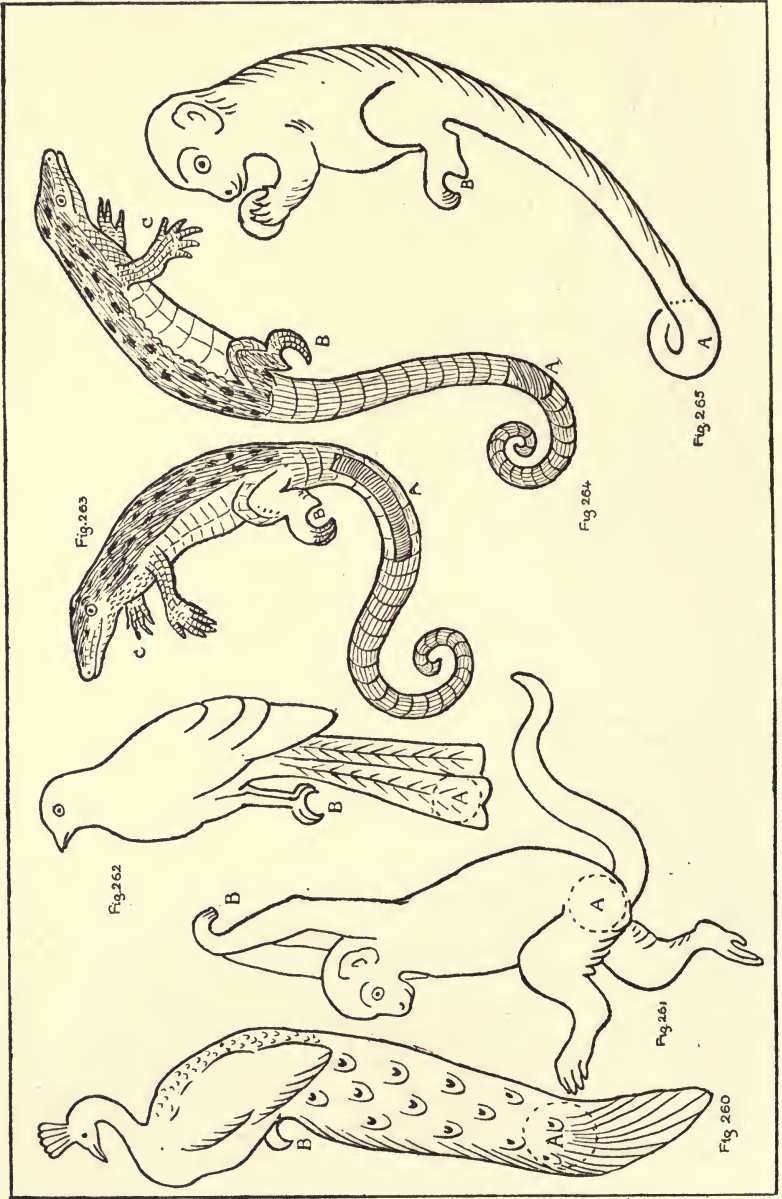



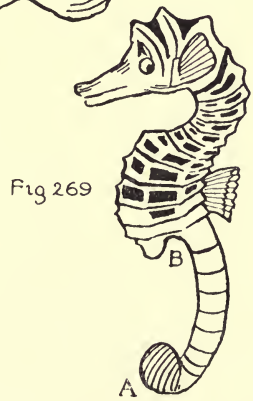
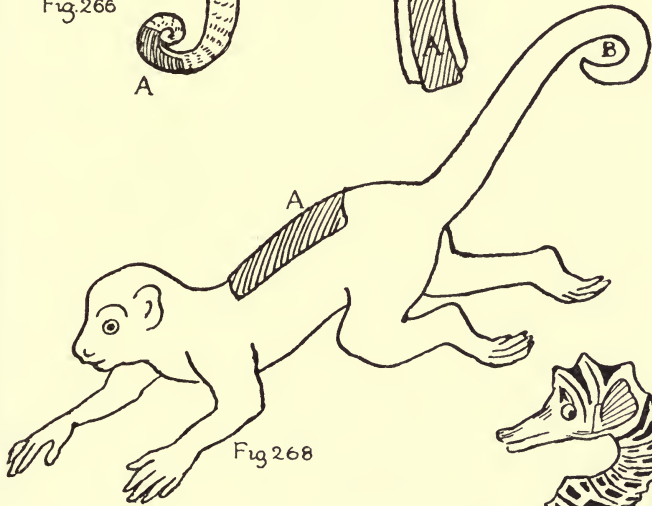
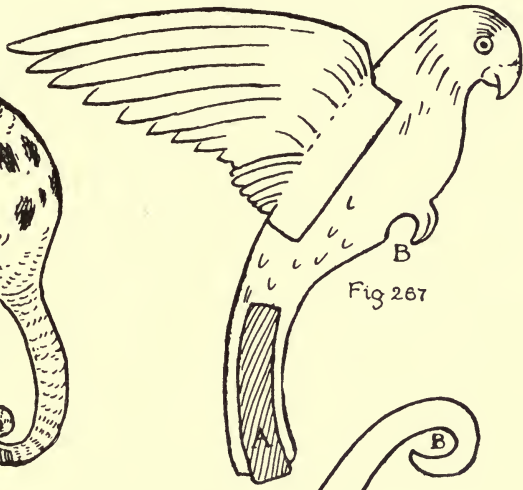
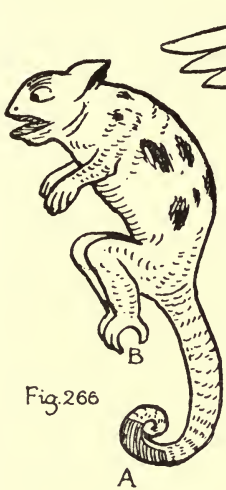

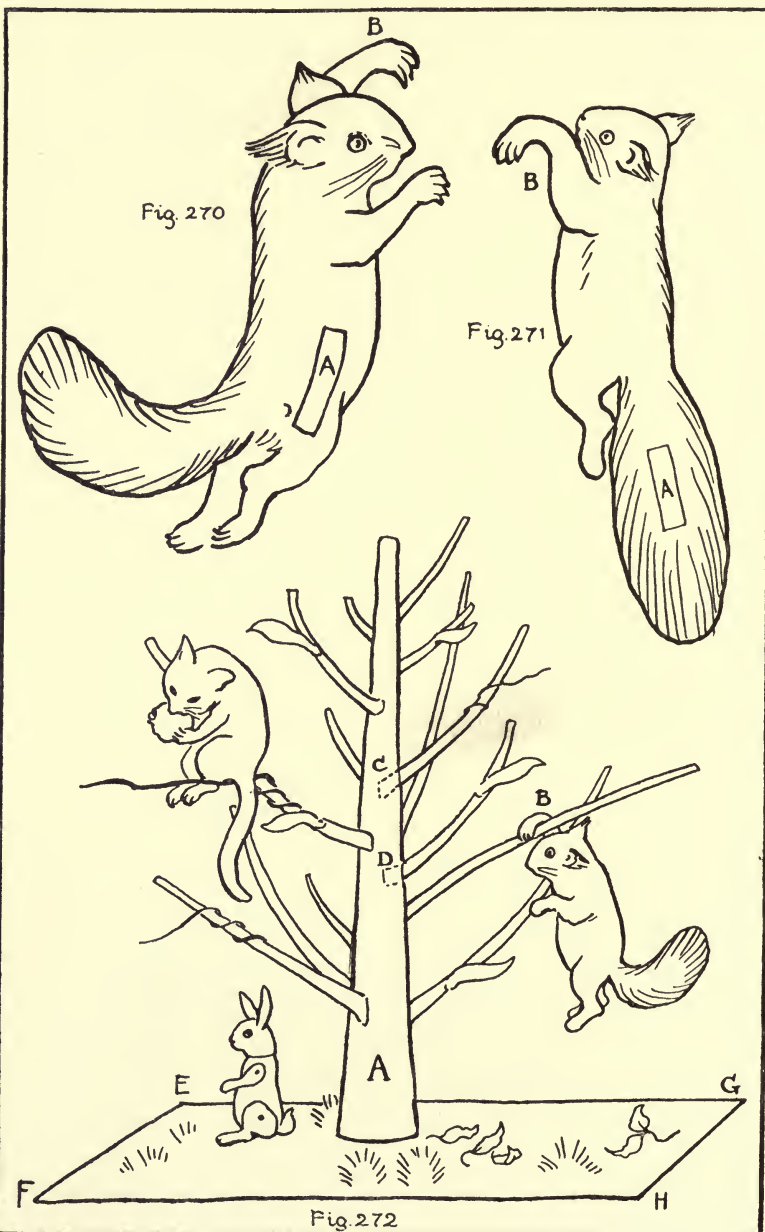

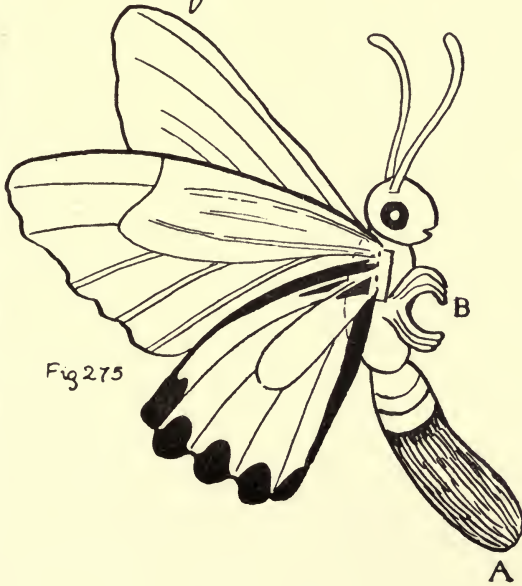
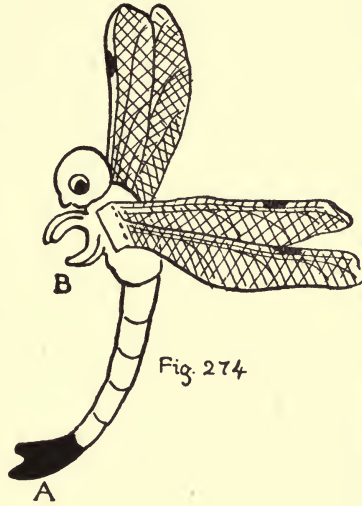
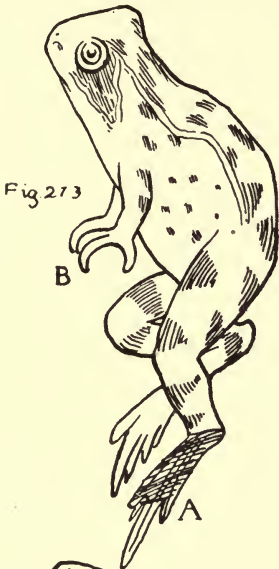

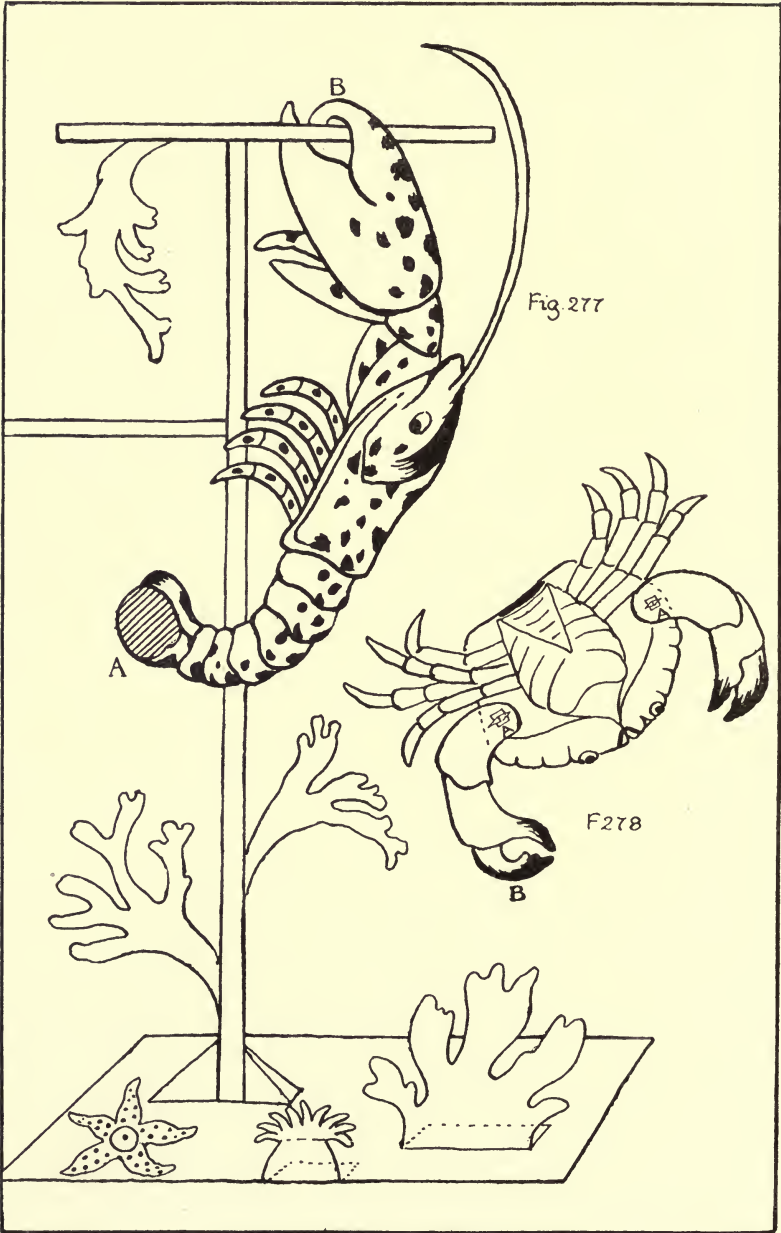

To make the **Elephant** cut out two pieces the shape of Δ for the body (Fig. 279), and make four holes in each piece as in the diagram. Next, cut out four legs, and fasten two to each portion of the body by little paper-fasteners, then cut out the tail and fasten it between the two pieces that form the body ; cut out two ears and

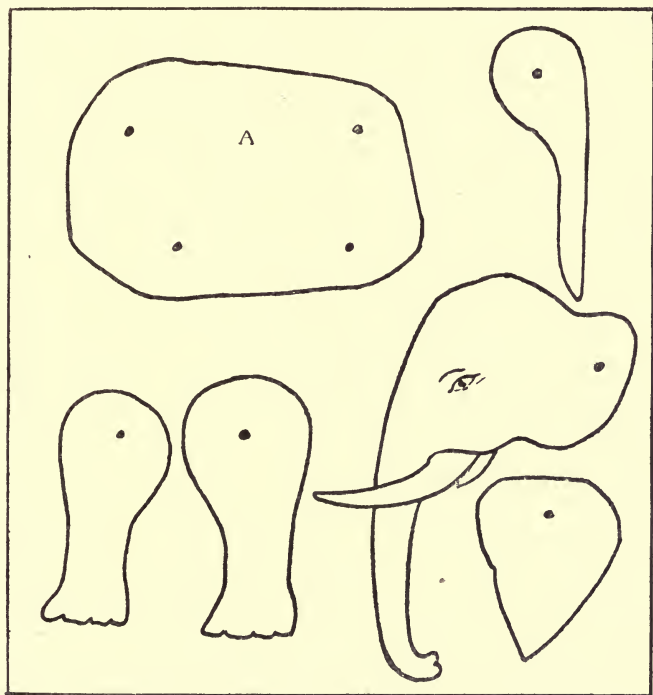

FIG. 279

the head ; one fastener will hold the ears, the sides and the head together ; the head is inside the two bodies, the ears outside.

The Giraffe (Fig. 255) can be made in a similar way.

The Butterfly and the Dragon-fly (Figs. 274 and 275) have their wings and feelers cut out of cartridge paper and gummed on to cardboard bodies, so that when the animals swing their wings wave in a realistic manner.

Fig. 277 shows how cardboard Crabs and Lobsters can be mounted amid under-sea surroundings.

PART II

CHAPTER I

ADDITIONAL TOOLS

BESIDES the tools mentioned in Part I, viz., bench-hook, hammer, saw, file, bradawl, pincers, the following additional tools will be found of service, though some of these are luxuries, and generally it is best to use as few as possible :

1. A larger saw, for sawing rougher and larger wood than strip-wood, e.g. a *Tenon Saw*, length 8 to 16 inches ; 10 to 16 points to an inch, price about one and ninepence.

2. *An Archimedean Drill*. This is useful for making small holes when there is danger of the wood splitting, however when once this drill is used, the worker never again feels inclined to use a bradawl or any other kind of boring tool. A quite useful and efficient drill can be bought for sixpence. Care must be taken that the drill bits or drill points do not break, for being quite slender and made of tempered steel they are rather fragile. A set of twelve drill points in assorted sizes in a metal case may be bought for sixpence. (For hints on the use of drill, see under fret-saw.)

3. The *Cramp* or clamp is a contrivance used for holding boards together. An adjustable G cramp is a handy article for small work. There are several models of G cramps ; that shown in the plate costs twopence.

4. A *Rasp* or rough file for removing from boxes either paper or the names that are sometimes stamped on them.

5. *Brace and Bit*. The smallest-sized brace, which has a sweep of 5 inches, is the most convenient for children. Bits are of many patterns. The most common form is the *Centre-bit* which will cut holes from $\frac{3}{8}$ inch to $1\frac{1}{2}$ inches in diameter.

The *Pin-bit* or shell-bit of the smallest bore is used to make

small-sized holes for screws, etc., but more especially when making preparation for using the centre-bit.

A *Centre-bit* $1\frac{3}{4}$ inches in diameter costs ninepence; a brace and bit ($\frac{3}{4}$ inch diameter) together costs one and threepence; this latter bit is useful for boring holes in wheels for axles, etc.

However the brace and bit is somewhat of a luxury and can be done without, for holes made with the Archimedean drill can always be enlarged to the required size, by means of round files and patience.

6. The *Mitre-block* is a piece of beech-wood carefully squared and rebated so as to present throughout its length a rectangular step-like recess in which the wood to be mitred is placed in order to be cut at the necessary angle.

In the raised part are three saw kerfs, two at an angle of 45° with the sides of the mitre-block and one half-way between these at right angles to the sides. The inclination of the saw-cuts at an angle of 45° is to the right and left respectively, so that when these angles are brought together in the mitred joint they may form a perfect right angle (90°). The mitre-block is a luxury, but it is useful in squaring off the ends of the wood, making picture frames, making the crane (Chapter V), etc., price sixpence.

A *Compass, Protractor, Ruler, Try-square* and well-sharpened *Pencil* will be found useful in making nearly every toy.

A *Plane* is not necessary for any of the toys described in the following chapters, but is mentioned here in case anyone should require one for reducing the thickness of wood or straightening a surface. The most economical one is a Jack-plane fitted with a smoothing-plane iron. The Jack-plane thus equipped may be used for reducing thicknesses of material (this is the real function of the Jack-plane) as well as for planing up surfaces true and smooth (the purpose of the smoothing-plane).

The Jack-plane iron has its cutting edge slightly rounded in order to gouge out the wood and thus reduce thickness quickly, the smoothing-plane iron is ground to a straight edge.

If both these irons are bought, the plane becomes both a Jack- and a smoothing-plane.

The Stanley Bailey adjustable iron plane is a good one. No. 5 size, 14 inches long, is recommended.

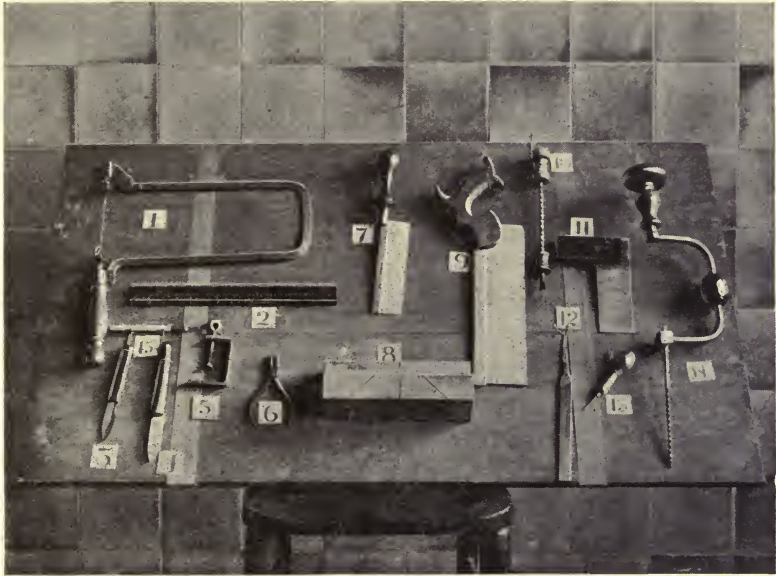

PLATE X

USEFUL TOOLS

146.

- | | |
|--------------------------------|-----------------------|
| 1. Fret-saw | 8. Mitre block |
| 2. 'Non-slip' safety ruler | 9. Tenon saw |
| 3. Card knife (London pattern) | 10. Archimedean drill |
| 4. Craft knife | 11. Try square |
| 5. G cramp | 12. File |
| 6. Round-nose pliers | 13. Bradawl |
| 7. Brass back metal saw | 14. Brace and bit |
| | 15. Carton knife |

However, as we have said before, it can be done without. The first four tools are the really necessary ones.

The Preservation of Tools. Keep tools in a dry atmosphere in a wooden box. Have them instantly dried after grinding and whenever they have been in contact with wet. Iron or steel parts should be frequently rubbed over with a piece of oily rag (if grease is used it must be free from salt). A speck of rust must be removed at once with fine emery-paper and oil.

A generous coating of oil or vaseline should be given when tools are laid aside for some time.

The Sharpening of Tools. Chisels, planes and knives are sharpened on oilstones. The Lily-white and the Rosy-red Washita oilstones are perhaps the best natural stones on the market. With regard to the oil used, machine, engine, neat's foot and sweet oils are all suitable. Clean the stone after use.

Knives are sharpened at an angle on both sides, and will therefore have one side rubbed on the stone a few times and will then be turned over to rub the other side.

Pen-knives can be sharpened on the ordinary kitchen knifeboard.

CHAPTER II

CAPSTAN, DREADNOUGHT, LINER

SAW a square piece of wood, side $4\frac{1}{3}$ inches, A B C D (Fig. 280). Cut two others, sides $2\frac{1}{2}$ inches. Saw the corners of these and

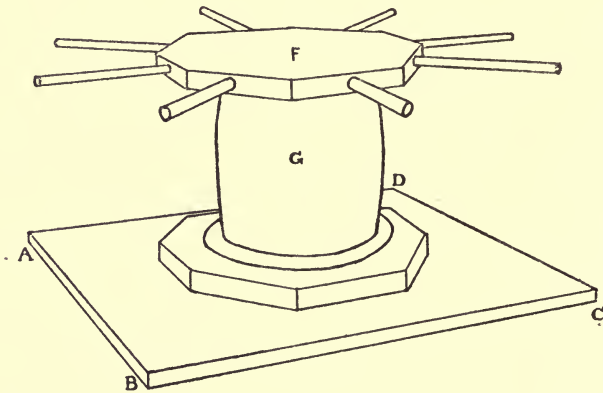

FIG. 280

make them octagons.¹ Drill a hole through the centre of E (Fig. 281). Into this hole glue a wooden meat skewer or round rod

¹ To make an octagon from a square A B C D. Draw A D and B C

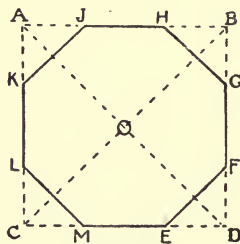

FIG. 282

(Fig. 282). With centre C and radius C O mark points E and K, with centre D and same radius mark M and G, and so on. Join E F, G H, J K, etc.

that will pass through the hole of a large reel. Glue and nail *E* to *A B C D*. Round the sides of *F* (Fig. 280) drill eight holes about $\frac{1}{4}$ inch deep. Make levers of wood to fit these holes as in Fig. 280. Match sticks could be used. Now glue *F* to the top of the reel, *G*, taking care that the centre of *F* is over the centre of the reel. Place the reel over the axle, round which it can be turned. The capstan can be used for dragging along a toy boat by means of a string tied to the boat and wound round the reel.

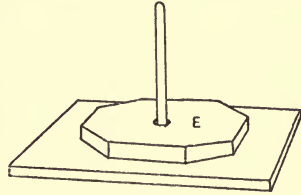

FIG. 281

A Dreadnought. The bottom of the boat is made from a piece of wood $9\frac{3}{4}$ inches by $2\frac{1}{2}$ inches. Shape the bow as in Fig. 283. To this glue another piece of wood, *A B C*, shaped to fit over the first, and about 6 inches in length. The two pieces can also be nailed together.

Cut a piece of wood, *D*, $2\frac{3}{4}$ inches by $1\frac{1}{2}$ inches, and glue and nail it to *A B C*. When these pieces are secure drill a hole through

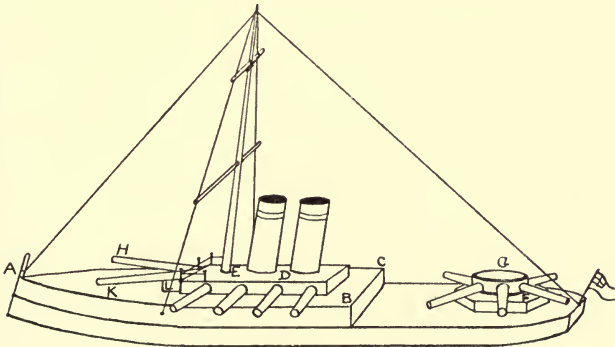

FIG. 283

them at *E* for the mast. To carry the guns at the stern, shape two pieces of wood, *G* and *F*, in the form of circles or octagons, and glue and nail them in their place. The mast has holes drilled through it to hold pieces of cane.

Nail $\frac{1}{4}$ inch nails round one end of *D* and tie black thread round them.

The guns are made of small rolls of brown paper, narrower

150 TOY-MAKING IN SCHOOL AND HOME

at one end and painted black or grey. They are glued in position. The guns η and κ , are fastened to a small piece of wood, L , to raise them above the level of the deck.

The funnels are made of pieces of round wood or rolls of paper. The whole boat is painted grey, and rigged with black thread.

A Liner (Fig. 284). The foundation of the boat is a piece of wood $10\frac{1}{2}$ inches by $1\frac{1}{2}$ inches, and about $\frac{1}{4}$ inch in thickness, or thicker if possible. Shape the bow as in the figure. Round the stern.

Cut two pieces of cardboard $7\frac{1}{2}$ inches by $1\frac{1}{2}$ inches. These are for the decks (Fig. 286), and their stern ends must be shaped to

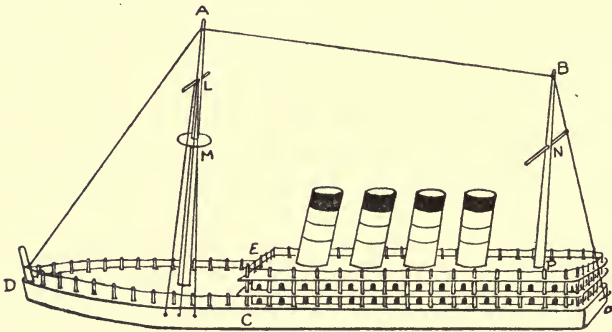

FIG. 284

correspond to the stern of the boat. Place them together on the foundation and make holes right through along their edges about $\frac{1}{2}$ inch apart.

Cut two pieces of stripwood $\frac{1}{2}'' \times \frac{1}{4}'' \times 6\frac{1}{2}''$. Place them one over the other and drill a hole ($\frac{1}{4}$ inch in diameter) at P , about

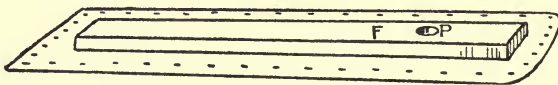

FIG. 285

$1\frac{3}{4}$ inches from one end; this hole is to receive the mast, B .

Along each piece of stripwood mark little doors and windows or port-holes. Glue each piece of stripwood along the middle of each cardboard deck, as in Fig. 285, having made holes in the cardboard corresponding to the holes P drilled in the stripwood. Now

glue the stripwood of one piece to the middle of the cardboard of the other piece, taking care that the holes in each piece of cardboard are over each other (Fig. 286). While these pieces are drying, drill a hole about 2 inches from the bow for the mast A ; drill holes along the edge of the bow (C D E), $\frac{1}{8}$ an inch apart. Cut pieces of cane $\frac{7}{8}$ inch to fit through the holes in the cardboard, and pieces about $\frac{3}{8}$ inch in length for railings round the bow. Now glue the stripwood, G, to the boat so that ends H and K correspond with the edge of the stern. While this is drying prepare the masts. The mainmast is about

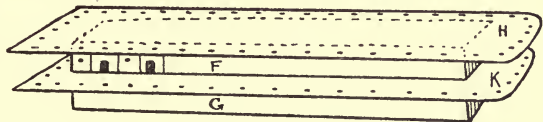

FIG. 286

4 inches in length ; this length allows it to stand 3 inches above the upper cardboard deck ; the foremast is about 5 inches. Round the foremast glue a circular piece of cardboard, M, resting on a nail passing through the mast. Hammer a nail through at L for a spar, and put a piece of cane through a hole at N.

Glue the masts into position. Put in a nail at O in the stern, and a piece of cane, D, at the bow. Hammer in three nails in side DC and three on the other side for rigging. Insert the strips of cane through the holes in the cardboard ; put a little glue into the holes in the wooden deck, and tap the cane in very gently ; put the smaller pieces of cane into the holes round the bow. Tie cotton round the pieces of cane as in Fig. 284 ; tie cotton to masts, etc.

The funnels are made of rolls of paper. If the liner is a Cunarder, the funnels should be red with black bands round the top and two black lines lower down. The wooden sides of the boat are painted dark brown.

CHAPTER III

MOTOR-CAR (PLATE VIII), SWINGING CRADLE, DECK-CHAIR

A PIECE of flat wood $2\frac{1}{2}$ inches by $5\frac{1}{2}$ inches forms the bottom of the car. Two pieces of wood, $5\frac{1}{2}$ inches by 1 inch, are marked out and sawn as in Fig. 287. If it is found too difficult to saw out the corner pieces E F G and H K L, piece A E C M can be cut right off,

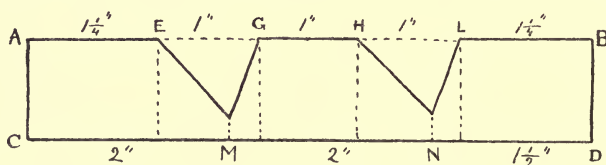

FIG. 287

by sawing along a line E M ; G M H N can be cut off by sawing along lines G M and H N, the same with L N B D.

The corners E, F, G, H, K, L should be rounded with a file, as shown in the plate. The two side-pieces are then glued at each side of the bottom. Front and back pieces are then cut, and fitted between the bottom and sides ; also a top to fit over A E, and seats to fit over G H and L B.

These seats are then provided with backs and arms as shown in the plate. Axles and wheels should be made and put on as described in Part I, Chapter XIII. The wheels should be $\frac{1}{2}$ an inch thick and have the edges rounded to represent the tyre. Lastly the steering pillar, with cardboard wheel attached, is fixed into bottom.

A drawback to this toy is that it is made of so many separate pieces of wood, but children delight in it and can make it most successfully. Children from nine to twelve have turned out most effective motor-cars.

A Swinging Cradle (Fig. 288). The *cradle* is a wooden box, 5 inches by $2\frac{3}{4}$ inches, and 2 inches deep. Before nailing this

together, holes must be drilled in the two short sides, large enough to take a wooden axle about $\frac{1}{4}$ inch in diameter.

A and B are two pieces of stripwood $\frac{1}{4}'' \times \frac{1}{2}'' \times 5''$; their tops are rounded and holes similar to those in the cradle are drilled in them about $1\frac{1}{2}$ inches from the top.

A is fastened to E, which is 4 inches in length, by means of triangular pieces of wood, C and D, which are glued and nailed to A and E.

F and K are wider pieces of wood, 5 inches by 1 inch. E is glued

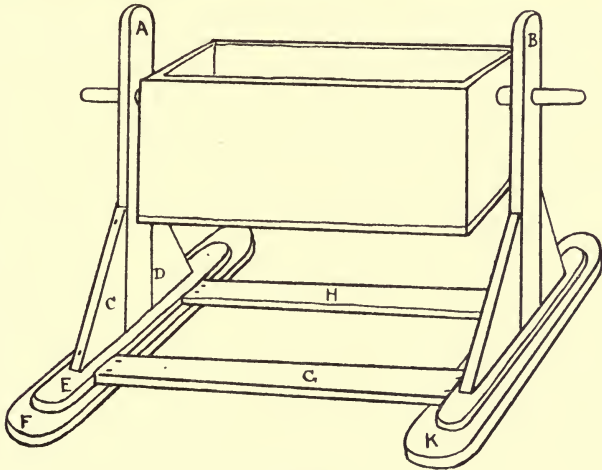

FIG. 288

and nailed to F; a wider space must be left on one side of E so that the supports, H and G, can be fastened securely to F. G and H are $5\frac{1}{2}'' \times \frac{1}{2}'' \times \frac{1}{4}''$.

For the axles on which the cradle swings two pieces of stripwood, $\frac{1}{4}'' \times \frac{1}{4}'' \times 1\frac{1}{4}''$ must be cut and rounded, passed through holes in A and B, and glued securely to the holes in the sides of the cradle.

A Deck-chair (Fig. 289). Two pieces of stripwood, $\frac{1}{4}'' \times \frac{1}{4}'' \times 6''$, A B, C D, are taken. These are nailed and glued to E and F, each $2\frac{1}{4}$ inches. E and F should not be placed too near the ends of A B and C D, as the wood may split when the nails are driven in. E and F may be rounded. For the smaller frame of the chair, cut two pieces of stripwood, 5 inches in length. To get

the measurements for the bars, M and L, place G H and J K inside A B C D as in Fig. 289, and measure distances G J and H K. This must be done very accurately. Before nailing G H and J K together, notches must be cut in them as in Fig. 290. The wood

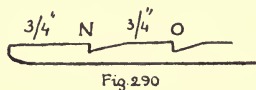

Fig. 290

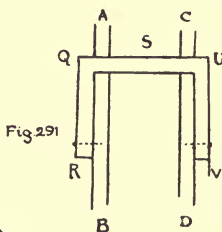

Fig. 291

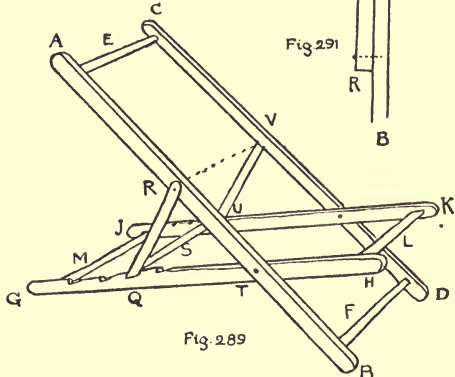

Fig. 289

is partly sawn through at N and O, and the notch is then filed out, the safe edge of the file being turned towards N and O. To make the support, two pieces of wood are cut 2 inches in length, Q R and U V in Fig. 291, which shows how the length of the piece of wood S, which fastens Q R and U V together, is obtained.

Frame G K is now nailed to frame A D (Fig. 289). Fix the point for the nail at T about 2 inches from H and B. When hammering the nail in at T, the bars A B and G H should rest upon the edge of the bench or table.

From A and C measure distances of $2\frac{1}{2}$ inches to R and V respectively. To these points nail the arms of the support, Q R and U V.

A piece of coloured print or casement cloth is fastened to E and L.

Other toys which can be made in a similar manner are a camp-stool, a clothes-horse, a screen.

CHAPTER IV

A TRAM-CAR

THIS toy is made of wood, cardboard and paper (cartridge).

A piece of wood, E F G H (Fig. 292), $8\frac{1}{2}$ inches by $2\frac{1}{4}$ inches is required for the bottom of the car, and two pieces, A B C D, 5 inches by $1\frac{1}{2}$ inches, for the sides.

The supports (1, 2, 3, 4, 5, 6) are pieces of stripwood $\frac{1}{4}'' \times \frac{1}{4}'' \times 3\frac{1}{2}''$.

Glue three of these to one of the sides as in Fig. 293, allowing

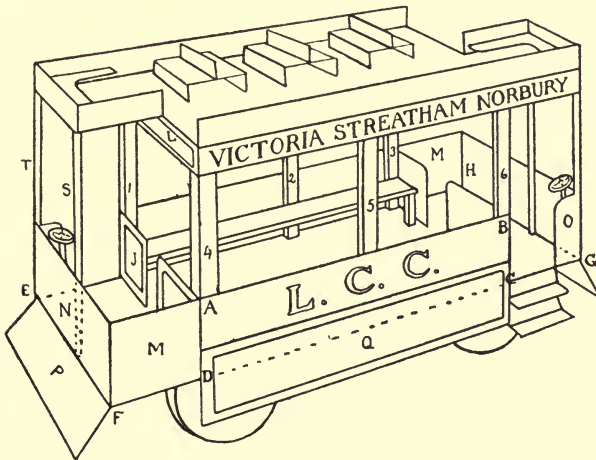

FIG. 292

A B C D to project beyond them for a space equal to the thickness of the wooden bottom of the car, E F G H. This forms one side of the car; make the other in the same way.

Fig. 294 shows how the sides and seats are fastened to the bottom of the car.

The seat is a piece of stripwood $\frac{1}{4}'' \times \frac{1}{2}'' \times 5''$.

The top of the car is made of thick cardboard cut as in Fig. 295 to the given measurements. Before the top is fastened on strips of cartridge paper are gummed round its sides. These strips are

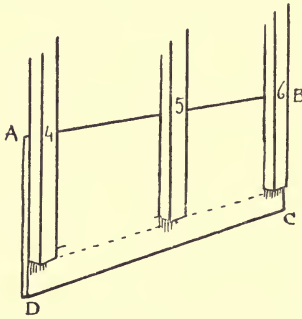

FIG. 293

about an inch wide, and are doubled in half; one half is gummed to the cardboard as in Fig. 296. The other half bends downward and the names of places to which the car runs are printed on it. Similar pieces are gummed to the top and bent upward to form the railings round the top (Fig. 297.)

These pieces are painted yellow and edged with dark brown. Fig. 298 shows the entrance to the interior of car. J and K are pieces of cardboard, coloured yellow, and glued into position; L is a similarly coloured piece of cardboard or paper glued to supports 1 and 4. The other entrance is finished off in the same way.

Cut two pieces of cardboard, $4\frac{1}{2}$ inches by $1\frac{1}{2}$ inches, as in Fig. 299. Make half-cuts along the dotted lines. These pieces are bent round and glued to the ends of the bottom of the car (M, N, O in Fig. 292).

These are also coloured yellow and their edges are dark brown.

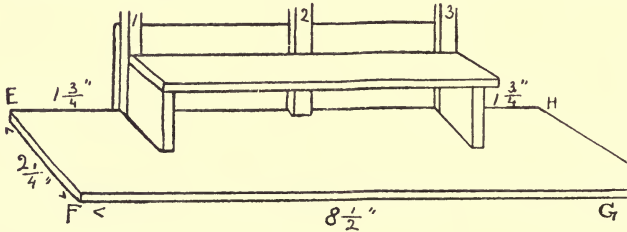

FIG. 294

The wheels are put on as the wheels of the engine (Part I, Chapter XIII).

Cut two pieces of cartridge paper (P in Fig. 292), colour as described before, and gum under each end of car.

Part Q is a piece of cardboard one inch wide, coloured like M N O, and gummed along the side, so that it covers at least half the wheels.

The top can now be glued on. Thin strips of wood or pieces of cane (s and t in Fig. 292 and 296) are gummed in position.

The steps into the car are made of cartridge paper coloured black.

Fig. 300 shows the simplest way of making the stairs leading to the top of the car.

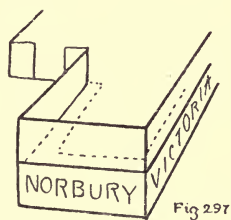
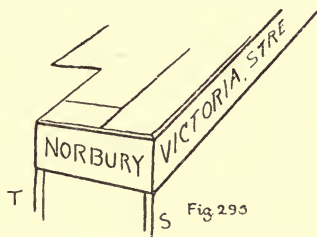
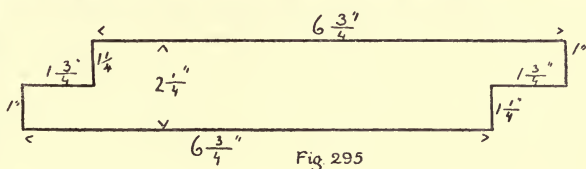

w x is a piece of cardboard, 1 inch wide, to which pieces of stiff

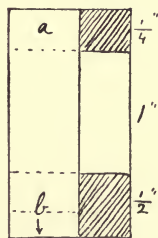
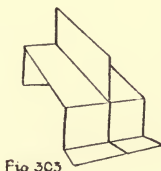
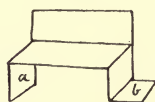
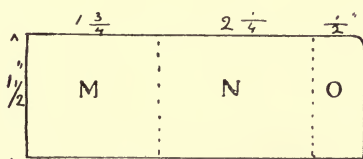
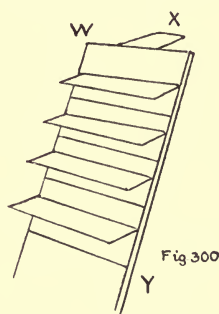
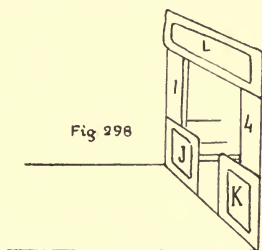

paper are gummed as in diagram. x is a flap of paper which fastens the steps to the top of the car.

Seats for the Top. Pieces of cartridge paper are cut out, $1\frac{3}{4}$ inches by $\frac{3}{4}$ inch, and coloured yellow. These are folded and cut as in Figs. 301 and 302. Part *a* is gummed to the side of the car, flap *b* is gummed to the floor. The second seat is gummed back to back to the first seat (Fig. 303). The top of the car will hold about six of these double seats. Single seats can be gummed in the corners.

Steering wheels are made as in Fig. 292. The top is of cardboard, cut or marked as in the figure and coloured black. This is gummed to a round rod, about $1\frac{3}{4}$ inches in length, which is fastened to the end of the car (N in Fig. 292). A similar steering-wheel is fastened to the other end.

CHAPTER V

A CRANE

A Crane. *Foundation, Arm, Pulley.* Cut a piece of wood about $5\frac{1}{2}$ inches by $4\frac{1}{2}$ inches (H in Fig. 304). Cut a second piece a square, A, side $2\frac{1}{2}$ inches. Cut off the corners. This forms a stand on which the crane, etc., is fastened.

Cut a piece of stripwood, $\frac{1}{4}'' \times \frac{1}{2}'' \times 8''$. This is the arm of the crane, c, and is usually inclined at an angle of 45° to 60° . To support this arm cut B with sides about $\frac{3}{4}$ inch, angles 45° or 60° and 30° .

Cut two pieces of stripwood $\frac{1}{4}$ inch by $\frac{1}{4}$ inch, each 2 inches

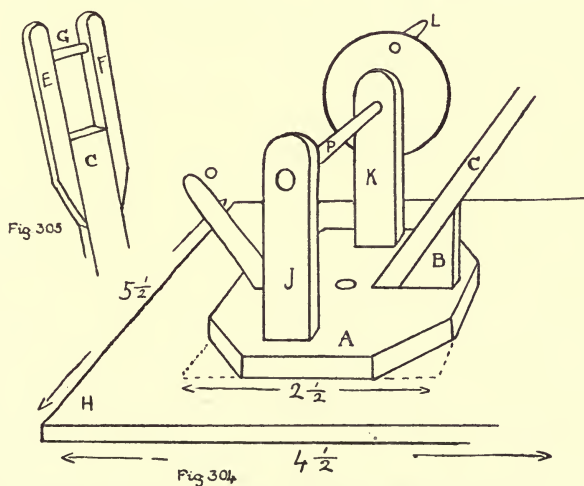

in length; shape like E and F in Fig. 305. These can now be glued and nailed to the arm c, projecting an inch beyond.

A wheel for the pulley is cut from a round rod about $\frac{3}{8}$ inch in diameter.

If a groove is to be made round the circumference, the wheel should be about $\frac{1}{4}$ to $\frac{3}{8}$ inch thick. The groove is made with a

file. A simple way to make the groove is to cut two cardboard discs a little larger in diameter than the wheel and glue them to each side of the wheel, in which case the latter need not be quite so thick. A hole is drilled through the wheel and enlarged by a round file to $\frac{1}{4}$ inch in diameter.

A piece of wood is now rounded for an axle, so that the wheel turns on it easily. This must fit tightly between E and F. Pass it through the wheel and glue it in position (G in Fig. 305).

Winding Gear. Cut two pieces of stripwood, $\frac{1}{4}'' \times \frac{1}{2}'' \times 2''$, J and K in Fig. 304. Round their tops, drill and enlarge holes in them.

A hole must now be made through the centre of A, to enable this part to rotate on the foundation H, so that the crane may swing round in any direction. One of the simplest ways of doing this is to use a rivet, but if such is not procurable a screw may be used; the hole in A is made large enough for A to turn easily on the pivot which can be screwed into H. Before this is done, pieces J and K are fastened to A about one inch apart. To do this, drive nails right through A in correct positions, glue the ends of J and K and hammer them on to the nails. The head of the nail should rest on a piece of metal when the wood is being hammered down on its point.

The support B should now be glued and nailed to A. When B is firmly fixed the arm C is fastened to it. The hole in the centre of A must be left clear.

A is now riveted or screwed to H. A wooden axle, P, is made to pass through holes in J and K, and to the ends of this axle wheels are glued. (The figure shows one only.) The wheels can be made from reels, or several discs of cardboard gummed together. Before glueing on the wheels, wooden handles, L, are fastened to them. A wooden handle O is fastened to A. This is used for turning the crane. A piece of stout thread is tied to and wound round P and passed over the pulley. To the end of this a hook is fastened, made from wire or a bent pin. Bags can be made and filled with sawdust, etc.

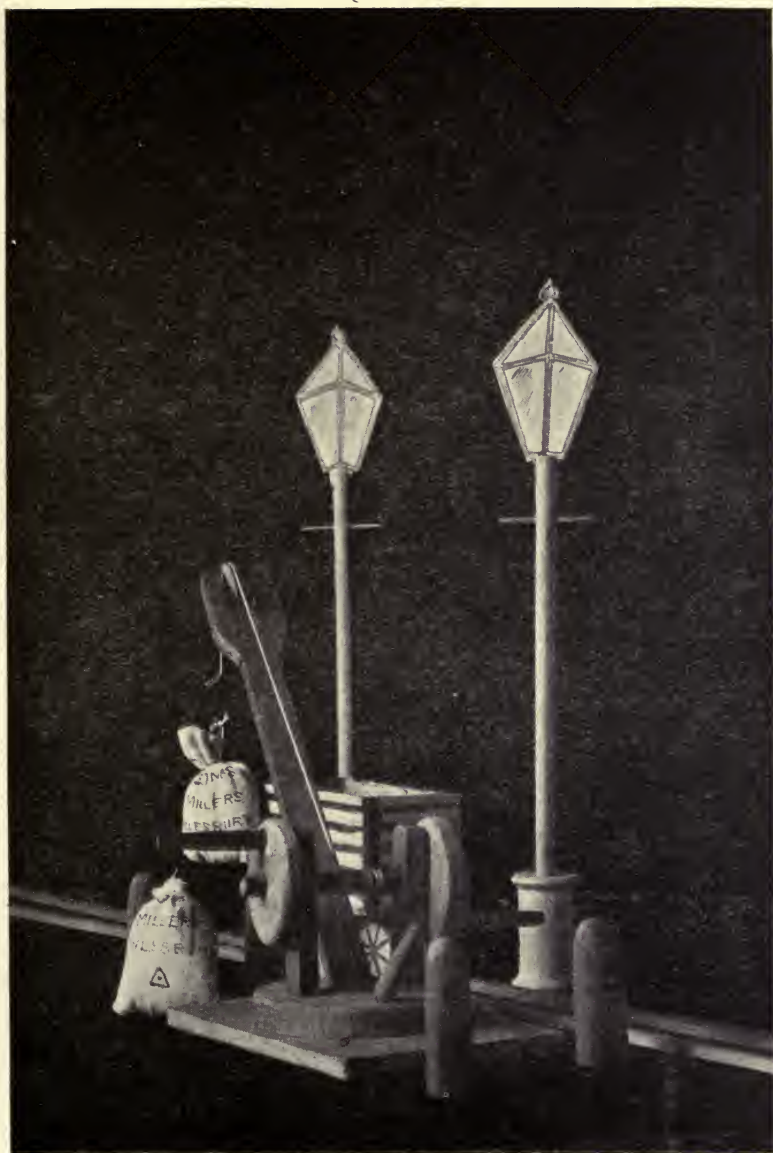

CHAPTER VI

WINDMILL, WATER-WHEEL, AND WELL

Windmill (Plate XII). Cut a square of wood, side 5 inches. This is the stand *A* in Fig. 306. To the centre of this glue a large reel, *B*.

Next cut two 4-inch squares of wood and drill through their centres holes of about $\frac{1}{4}$ inch in diameter. Glue one to the top of the reel so that the holes coincide. Next cut and glue into position the supports, *c*. For these stripwood $\frac{1}{2}$ inch by $\frac{1}{2}$ inch can be used.

Cut two pieces of wood, 4 inches by 6 inches. These form two sides of the windmill; glue and nail them to the other 4-inch square, which forms the bottom of the windmill.

Next cut two pieces of wood as in Fig. 307, for the other

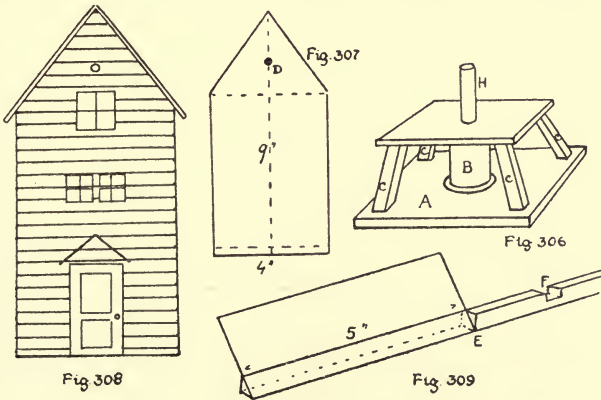

sides of the windmill. Drill a small hole in each at *D* about $1\frac{1}{2}$ inches from the top.

On one of these sides mark and paint a door and windows as in Fig. 308, and over the door make a small roof, like the roof over the porch of the signal-box (Chapter XII). The windows

and door may be cut out with a fret-saw and the door hinged on by means of a strip of strong linen. Glue and nail these sides in position. Make and fix the roof.

The Sails. For these, two strips of wood, $\frac{1}{4}$ inch square and 12 inches long, are necessary.

In the centre of each of these, cut a slot half-way through the wood so that one may fit tightly into the other (F in Fig. 309). The sails are made of cardboard, and are rectangular in shape, measuring 5 inches by 2 inches. They are coloured light brown, with dark markings on them, as shown in the plate. Shape each end of the arms of the sails as in Fig. 309. This is easily done by filing, if the wood is fairly soft. Saw halfway through the wood at E, and file, or cut off the wood with a pen-knife. To this flat surface the sails are glued, so that they may be inclined to the wind. Now glue the two arms together, and when they are firm make a hole through the middle, F, where the arms cross. Take a short steel knitting needle, about $6\frac{3}{4}$ inches; fix one end into this hole with glue; then glue a small piece of cardboard or wood over it, and a cork washer behind, to keep the sails from touching the walls of the windmill; pass the needle through the holes in the sides of the windmill and glue a little knob of wood to the other end to prevent the needle slipping back. If a needle cannot be obtained, an old bicycle spoke, or even a wooden meat skewer, will do, but in the latter case the holes in the walls must be made larger, and the sails fixed to the end of the skewer by a small nail.

Now glue a piece of round rod into the reel (H in Fig. 306) so that it projects about an inch. Place the mill on this stand, so that the rod passes through the hole in the bottom of the mill. The mill can be turned round in any direction so that the sails may catch the wind. Make a small ladder to reach the door.

A very pretty but somewhat more difficult windmill is shown in Fig. 310. It is made of cardboard. The foundation, platform and railings can be made as described in the case of the lighthouse (Chapter XIII).

The truncated hexagonal pyramid forming the body of the windmill is made as follows. With centre O (Fig. 311), and a radius of about 10 inches, describe an arc, A B.

From any point on this arc mark off six spaces, each 2 inches.

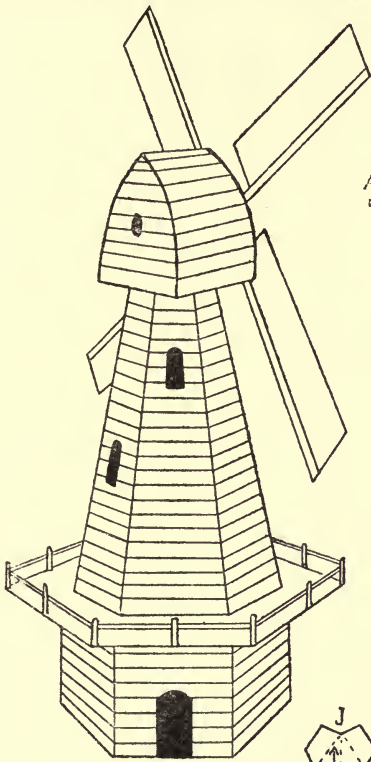

Fig.310

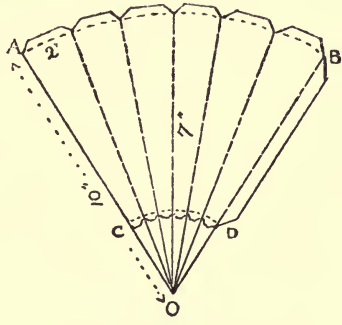

Fig.311

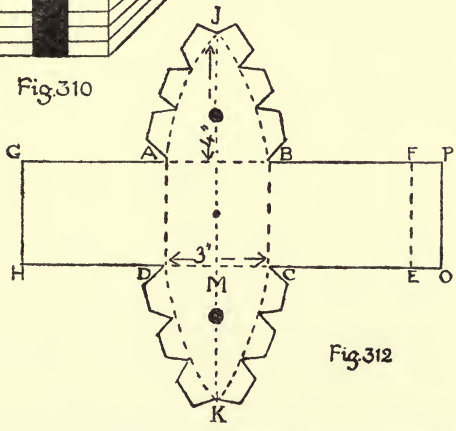

Fig.312

Join the several points to each other and to o. With radius about 3 inches make arc c d. Join points where c d cuts radii, by dotted lines. Draw the flanges; make half cuts along the dotted lines, cut out along the dark lines, and fold into shape. Fasten together with seccotine; turn in the flanges at the bottom, and fasten them to the platform.

The *Top of the Windmill* can be cut from one piece of cardboard. Draw square, A B C D (Fig. 312), large enough to project beyond top of hexagonal pyramid (side of square should be about 3 inches). On the middle of D C draw M K = 4 inches, and draw a similar line on A B. Join A J, J B, K D and K C, by curved lines. Produce A B and D C both ways. Make B F, C E, D H, A G, equal in length to arc B J. Draw the flange E F P O. Make holes in the middle of A J B and D K C through which the knitting-needle (on which the sail is fastened) may pass. Draw flanges on B J, J A, etc. Make half cuts along the dotted lines, and cut along the dark lines.

Before fastening the top together, put a very small paper-clip through the middle of square, A B C D, and fasten it to a square of cardboard of the same size, so that it turns freely on it. This second square will be gummed to the top of the hexagonal pyramid, so that the top of the windmill may be turned in any direction. Bend up A J B and D K C at right angles to square, A B C D. Bend up B C E F and A D H G and gum them to the flanges of A J B and D K C; gum flange F O to A D H G. The sails are made as already described.

A Water-wheel (Plate XII). *The Wheel.* Cut two discs of cardboard, 4 inches in diameter. Make holes in the centre, glue them to a small reel (about an inch high), and pass a round rod through for an axle. This wheel is an overshot water-wheel—that is, one that receives the water *shot over* the top, and must be fitted with ‘buckets.’ These receive the water at the top of the wheel and retain it until they reach the lowest point (see Fig. 313).

The ‘buckets’ may be made of stiff paper or thin cardboard. Cut pieces 1 inch in width, and in length the distance of the two wheels apart plus $\frac{1}{2}$ an inch. Mark these out as in Fig. 314, where *a b* is the distance between the wheels, and *c, d, e, f* are flanges for fastening the bucket to the wheels. Fold as in Fig. 315. Make at least twelve of these buckets; divide



WINDMILL, AND WATERMILL,

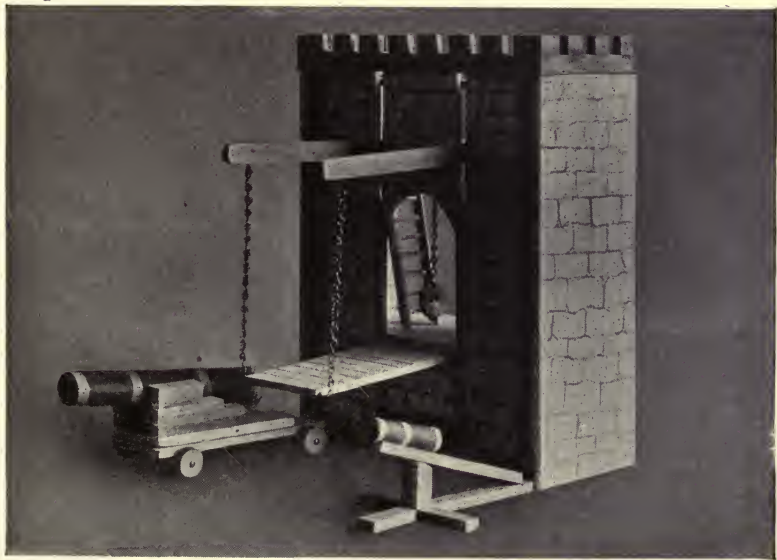

PLATE XII

DRAWBRIDGE
(Chapter VII)

the wheel into twelve parts, and fasten the buckets between the wheels.

To make the toy technically correct, the buckets should rest against a solid wheel contained within the two outer ones, as in Fig. 313, so that no water can run down toward the centre of the wheel. This can be easily managed, if desired, in the following manner :

Before fastening the wheels to the reel, cut a long strip of paper, with flanges, as in Fig. 316, in which $a b$ is the distance between

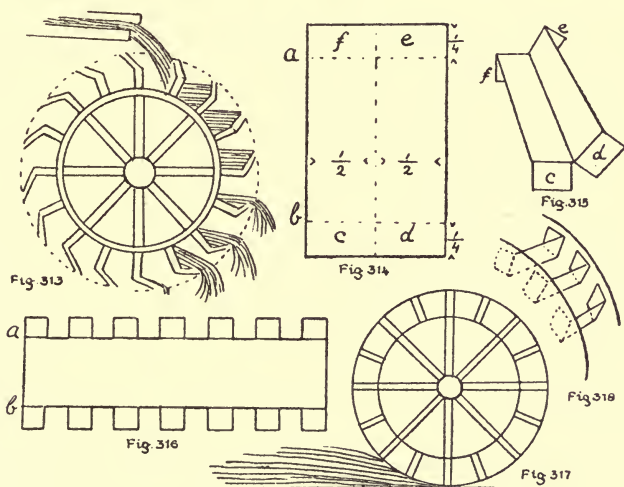

the two outer wheels. Describe a smaller circle on one of the wheels, about 3 inches in diameter ; glue the reel in position, then bend down the flanges of this strip of paper (Fig. 316), and gum these round the smaller circle of the wheel. Now gum the other wheel to the reel and to the flanges of the paper.

The wheel should be painted brown, with spokes marked in darker colour. The plate shows the wheel and the mill-house. A hole is made in the side of the house, into which the axle of the wheel is inserted ; the other end is held by the upright standard shown in the plate. The shoot may be made of cardboard ; it should slope a little and should come just over the top of the wheel, which revolves freely beneath it.

A chimney may be made of a cork, one end being cut on the

slant, so that it stands upright on the roof, which is made of cardboard. The whole should be suitably coloured.

An Undershot Wheel. This wheel is very simple to make. It has a number of float-boards arranged round it and is turned by a stream of water moving against the float-boards at its lowest point (Fig. 317).

Fig. 318 shows how the float-boards, which are made of cardboard, are fastened between the wheels. With this undershot wheel, the shoot represented in the plate is not required.

A Well (Fig. 319). The round part of the well is made from a mantle-box or other round box. A is a fairly deep box turned upside down, with a circle cut out into which the mantle-box

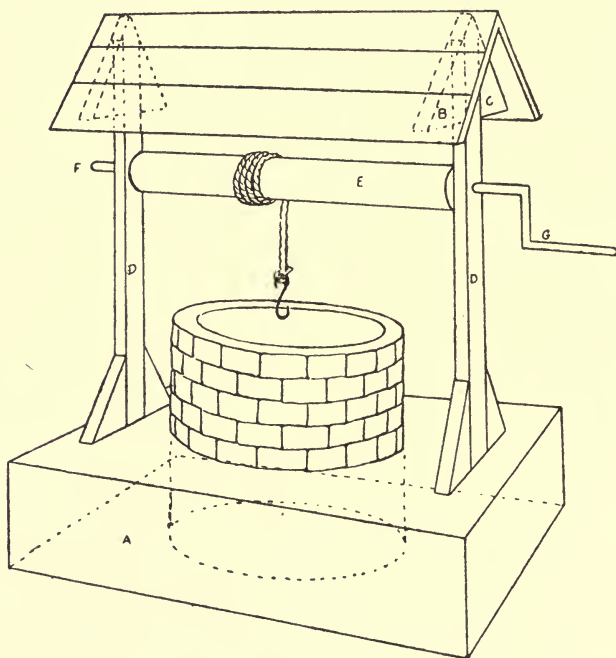

FIG. 319

fits closely. This gives a fair depth. Cover the well with paper coloured to represent bricks; colour the box, A, green. The cardboard roof is glued to posts, D, and to triangular pieces of wood, B and C, glued to each side of D.

Holes are drilled through the posts to take the roller, E, which is a round rod about $\frac{1}{2}$ an inch in diameter. Drill small holes in it at each end. Push a pin from the end F through the side post into the roller. Bind a piece of wire to form a handle, G, and push one end of this into the roller. Bend a piece of wire or pin to form a hook, tie this to a piece of string, wind it round the roller and fasten the other end of the string to roller with secotine. If a small chain is used this can be fastened by one of its links to the roller with a staple, and should be so fastened before the roller is put in position.

CHAPTER VII

DRAWBRIDGE AND SIEGE TOWER

A Drawbridge (Plate XII). Two pieces of wood for the front, *H* and *I* (Fig. 320), must first be sawn 11 inches by $2\frac{1}{2}$ inches. The white wood of chocolate boxes, etc., is the best.

Next two strips of wood, $7'' \times \frac{1}{4}'' \times \frac{1}{4}''$ are cut (satin walnut stripwood will do)—*D E* and *F G* in Fig. 321.

The bridge is made of a piece of white wood, $2\frac{5}{8}$ inches by $5\frac{1}{4}$ inches. The posts, *D E* and *F G*, are nailed to the bridge so that the bridge turns on the nails. (Note that the bridge is nailed about $3\frac{1}{4}$ inches from bottom of post.)

Next two lengths of stripwood, *R S*, are sawn $10'' \times \frac{1}{2}'' \times \frac{1}{4}''$, these are nailed to pieces *H* and *I* (nails are about $8\frac{1}{2}$ inches from bottom), so that the portions *R T* project about $5\frac{1}{2}$ inches. The strips *R S* turn freely on their nails.

Before nailing them in position, their ends should be rounded as in the figure. The posts *G F* and *D E* (which hold the bridge) are then glued to *H* and *I*. A piece

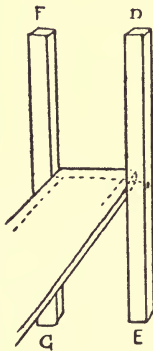

Fig. 321

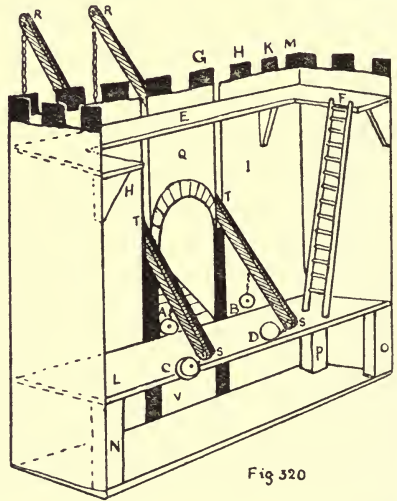

Fig. 320

of wood, *v*, about 8 inches by $2\frac{1}{8}$ inches, is glued to the lower parts of *H* and *I*, and joins them together.

Next the piece of wood Q is cut; its width will be the distance of post F G from D E (about $2\frac{1}{2}$ inches)—this distance should be carefully measured so that the piece fits well; its length will be about 5 inches. The arch is cut with a fret-saw. Piece Q is kept in position by having the ends of the arch glued to posts F G and D E, and by a length of stripwood ($\frac{1}{2}$ inch by $\frac{1}{4}$ inch) glued along the top as shown in the plate. Lengths of stripwood ($\frac{1}{2}$ inch by $\frac{1}{4}$ inch) may also be glued down the sides. Holes must be drilled in the ends, R, for wire loops, care being taken that these holes are over the bridge; wire loops must be placed on the bridge exactly underneath, and these loops are joined by chains, which can be made of wire or else bought from an ironmonger.

Fig. 320 shows the inside of the drawbridge; A, B, C and D are the lead weights for raising and lowering the beams. These weights can be cut from a piece of sheet lead or may be lead buttons. They are attached to the beams by chains and wire hooks. E F is a ledge for the defenders of the bridge to stand on. Sides have been added and a platform, L. The battlements, G, H, K, etc., are made of pieces of stripwood $\frac{1}{2}'' \times \frac{1}{2}'' \times \frac{1}{4}''$, glued round the top.

The ladder is made of matches as described in Chapter IX.

A Movable Siege Tower (Plate XIII). Two pieces of wood (A and B in Fig. 322) are sawn to the shape and measurements of Fig. 323. To the broader ends of these, pieces of stripwood $\frac{1}{2}$ inch by $\frac{1}{2}$ inch are glued and nailed (C in Fig. 323), and other pieces, D, $\frac{1}{4}$ inch by $\frac{1}{4}$ inch (about three on each side), are fastened at equal distances apart. D₃ and the corresponding piece on the other side must not extend to edge of B, but a space must be left of $\frac{1}{2}$ inch for the posts of the drawbridge.

Next the wood is cut for the foundation and the platforms, J, H, etc.

A stands about 6 inches from B, so this must be the width of all the platforms, except the foundation, F, which is wider and projects about $\frac{3}{4}$ inch on each side of A and B, and the platform K, which rests on A and B.

The other dimensions of the platforms will be the same as those of the pieces of stripwood on which they rest. The platform K must be about $\frac{1}{4}$ inch narrower than tops of A and B, to leave room for posts L and M. A and B are now glued and nailed

to the base by means of the pieces of stripwood, *c*, at their ends, and the platforms are glued in position.

Two pieces of stripwood $\frac{1}{4}$ inch by $\frac{1}{2}$ inch, *s* and *t* in Fig. 324, are now cut equal in length to distance of *k* from *n*, for the supports of bridge. Place these in position between *k* and *n*, and measure distance between them; this gives width of drawbridge; its

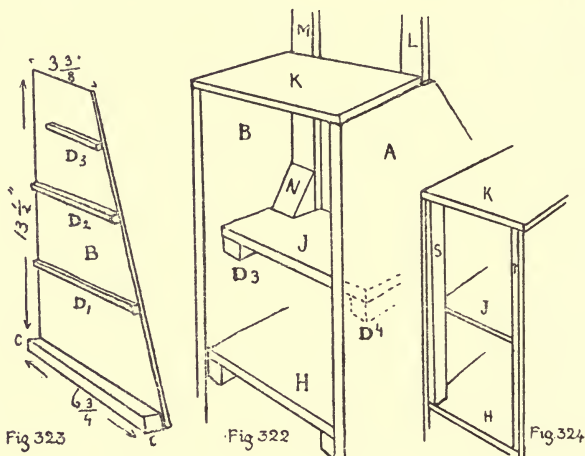

length is $6\frac{1}{4}$ inches. This can now be sawn. Fix in position as explained for previous toy.

Next cut two pieces of stripwood $\frac{1}{2}'' \times \frac{1}{4}'' \times 10\frac{1}{2}''$, *L* and *M*. At the ends of these drill holes, $\frac{1}{4}$ inch in diameter, through which passes the chain of the drawbridge. Fix these in position by triangular wedges glued to sides and to platform *J*.

On top, *K*, add struts to support *M* and *L*, as shown in the plate. The chains of the drawbridge are looped over nails driven into *A* and *B*, just above platform *J*.

The base may be mounted on small wheels and strengthened with projecting beams by which the tower may be pushed into position. (These are not shown in plate.) Ladders to reach the top can also be made (see Chapter IX), and a battering ram may be swung from platform *H*, as shown in the plate. A tower of this kind was used by the Crusaders in the siege of Jerusalem (1099).

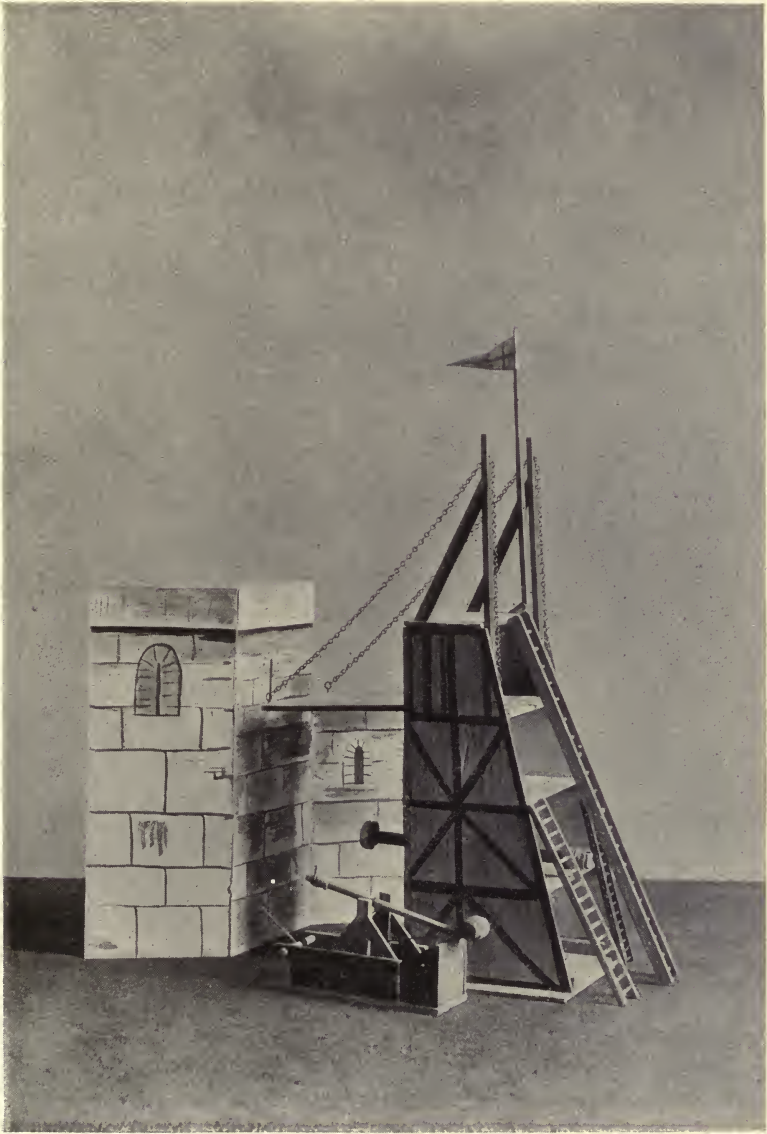

CHAPTER VIII

WAR ENGINES PAST AND PRESENT

A War Engine (Plate XIII). This piece of artillery was used at the time of the crusade of Richard I. It is a simple and interesting model to make. The sides (A B C D in Fig. 325) are built up of pieces of stripwood $\frac{1}{4}$ inch by $\frac{1}{4}$ inch, length about 3 inches, or the sides may be pieces of cigar-box. If made of stripwood, grooves

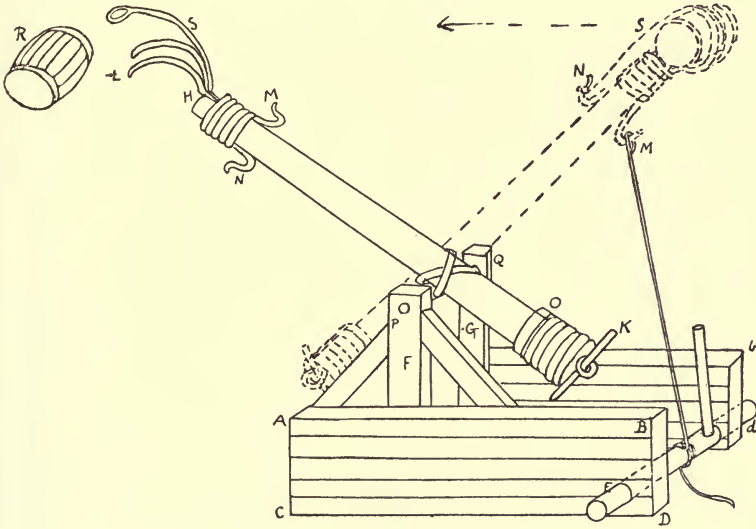

FIG. 325

can be filed in the two bottom pieces to make holes, E, when these pieces are glued together. A round rod passes through these holes to form a windlass. Two posts, F and G, $\frac{1}{4}'' \times \frac{1}{2}'' \times 3\frac{1}{4}''$, are glued to the sides about $1\frac{1}{2}$ inches from end, A C, as in figure; these must either have holes drilled through them for a rod of wood (or thick wire) or have circular grooves filed in the tops into which a rod can be glued.

The sides $a b c d$ and $A B C D$ should be about $2\frac{1}{2}$ inches apart, and are kept together by pieces of stripwood glued across the bottom. Make struts as in the figure to support posts F and G .

The beam $H K$ may be made from a piece of stripwood, $\frac{1}{2}'' \times \frac{1}{2}'' \times 5''$, filed to a round shape. Two pieces of wire, $L L$, are bent to form a fork and two hooks, M and N are bound firmly to one end with thread. The other end, K , has a small screw-eye screwed into it through which passes a wooden bolt to keep the rings of lead, O , from slipping off. These rings of lead are easily made from strips cut from a piece of sheet lead and bent round the beam. (A pair of old scissors should be kept for cutting lead, or a knife and hammer may be used.)

Now the beam $H K$ must be fastened to rod $P Q$. This may be done in different ways. The simplest but least effective way is to bind the beam firmly in the middle to the rod with thread or elastic.

A second way is to drill a hole through the beam, through which the thread or elastic that binds it to the rod can pass. The best way perhaps is to make the hole in the beam large enough for rod $P Q$ to pass through, and then bind it to the rod with elastic or thread or, if a large model is being made, catgut. (A jeweller is generally ready to give away a small quantity of this.) A barrel, R , can be filed or cut from a small piece of wood or cork, or it may be a small reel.

To work the machine pull the beam down by means of a piece of thread looped on to the hook M and wound around the windlass. When the beam head is down, place the barrel on the fork and keep it in position by rope, S . When the beam head is released, it flies up and the barrel is shot forward.

This trapget or war engine was used for casting Greek fire, with which the barrel was filled. It may interest the maker of this toy to know its composition. In the words of an old writer: "You make Greek fire thus: Take quick-sulphur, dregs of wine, Persian gum, 'baked salt,' pitch, petroleum, and common oil. Boil these together. Then whatever is placed therein and lighted, whether wood or iron, cannot be extinguished except with vinegar or salt."

Generally this engine had a kind of wooden hood in front to protect those working the machine (Fig. 326). This hood is easily made of stripwood or an old cigar-box. Notice that the stripwood that forms the sides, A B C D, must be longer (extended in diagram to S T), so that strips of wood, 1, 2, 3, 4, 5, can be nailed and glued as in diagram.

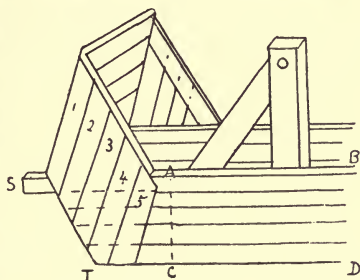

FIG. 326

The Mangonel, Fig. 327 (an instrument for casting great stones to beat down walls and to slay the enemy), makes an interesting toy.

First cut two pieces of wood, $10\frac{1}{4}$ inches by $1\frac{3}{4}$ inches (the sides of a wooden chocolate box will do when sawn the right size and filed), and shape them as in Fig. 328. Saw slits in both pieces at

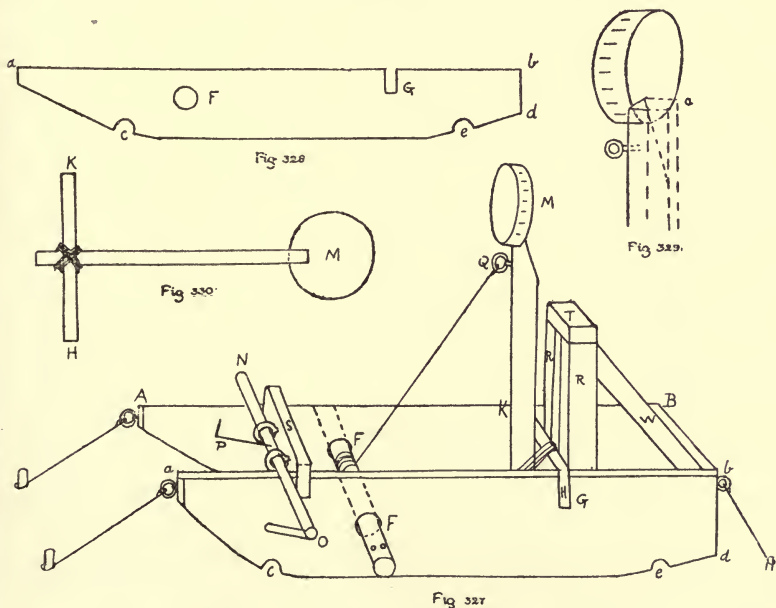

Fig 327

G, $\frac{1}{4}$ inch wide and $\frac{1}{2}$ inch deep. If two saw-cuts are made for each slit the wood between can be cut away with a pen-knife. These slits must be about $2\frac{3}{4}$ inches from end, *b d*.

With a round file make semicircles at *c* and *e* to hold the rollers on which the engine is moved into position.

With a bradawl and round file make holes, *F*, in both pieces about $3\frac{1}{2}$ inches from end, *A* (diameter of hole about $\frac{3}{8}$ inch, or larger if a larger windlass is required).

Put these two pieces aside, and next saw a length of stripwood, $\frac{1}{2}'' \times \frac{1}{2}'' \times 5''$; saw a slit about $\frac{1}{4}$ inch from one end and hammer it on the metal top of a bottle of Le Page's liquid glue as in Fig. 329. The corner *a* should be cut or filed off. A small screw-eye is screwed into the wood just below the metal top. Saw a piece of stripwood, $\frac{1}{2}'' \times \frac{1}{4}'' \times 3\frac{1}{2}''$, tie this firmly with elastic to the other end of the first piece of stripwood as in Fig. 330. This elastic constitutes the propulsive force. The ancients used catgut, which formed a thick coil, stretched from *H* to *K*, the lever passing through the middle of the coil. The pulling down of the lever gave additional twist to the coil, which reacted strongly on release. Now fasten the sides *a b c d* and *A B C D* together by nailing and glueing them to two pieces of stripwood, $\frac{1}{2}'' \times \frac{1}{2}'' \times 2\frac{1}{4}''$. Then glue *H K* securely into the slots *G* so that the beam with the stone-holder *M* is upright. Push a round stick through the holes *F*, for a windlass; this can have holes drilled in the portions that project, to hold sticks for turning the rod. A piece of thread is tied to the screw-eye *Q*, and wound round the windlass *F*; when this thread is tightened the beam is pulled down, then when let go it flies up, causing anything placed in the tin, *M*, to be shot some distance. The safest 'stones' to put in this pan are pieces of cork or small pieces of wood. The following additions can be made to the model:

- (1) *RR* are pieces of stripwood, $\frac{1}{2}'' \times \frac{1}{4}'' \times 4''$, glued to the sides and carrying a strip, *T*. This strip *T* in the olden days was covered with leather and was so placed that the beam carrying the stone-holder would abut against it. Notice the struts *w* for supporting the posts *R*.
- (2) *N O* is a rod (about $\frac{1}{4}$ inch in diameter) passing through two small screw-eyes fixed in a piece of stripwood, *S*, $\frac{1}{2}'' \times \frac{1}{4}'' \times 3\frac{1}{4}''$. A piece of strong wire, *P*, passes through hole in rod *N O*; it is bent so that it cannot work out, and the other end is bent to just catch the holder, *M*, when it is pulled down. A releasing handle is fastened to the

rod, *NO* at *O*. The beam *s* is glued into slots in *ABC D* and *abcd*, so that when the beam is pulled down the catch *P* clutches *M*.

- (3) Small screw-eyes may be screwed in at *A, a, B, b*, for holding ropes to fasten the machine to pegs in the ground. Rollers may also be made to fit under *c* and *E*.

This toy is an attractive one, because it really works successfully. It must be strongly put together, for the beam when pulled down flies up with considerable force.

Stone-throwers like this were used at the siege of Acre. Very often these engines had special names given to them. For example Philip of France had a very good engine of war called 'The Bad Neighbour,' and inside Acre the Turks had one called 'The Bad Kinsman.'

Cannons of the Fourteenth Century. These are very easily made. Figs. 331 and 332 show two that can be copied.

In Fig. 331 a piece of wood is cut to the shape of *AB*; a groove is then filed in it, into which the cannon *c* is glued. The cannon

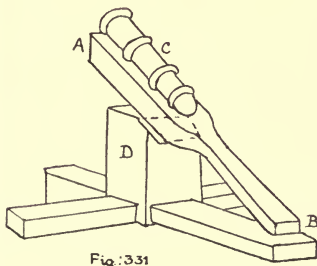

Fig. 331

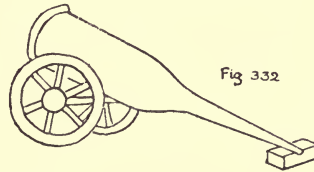

Fig. 332

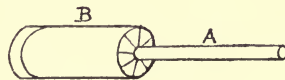

Fig. 333

may be made of a roll of brown paper (two pieces may be pasted together for greater strength) with four bands of cartridge paper painted yellow and gummed round it, or it may be a piece of wood filed to shape and circled with bands of lead.

The cannon in Fig. 332 consists of two cardboard wheels on an axle of stripwood, $\frac{1}{4}$ inch by $\frac{1}{4}$ inch, and the cannon is glued to a groove in the axle. It may be made of wood with a lead rim, or of two rolls of brown paper as in Fig. 333, where the flanges of the smaller roll *A* are gummed to flanges of *B*.

Cannon of the Fifteenth Century. This may be made of a short mantle-box (with lids on), cardboard wheels and pieces of stripwood, $\frac{1}{4}$ inch by $\frac{1}{4}$ inch. Fig. 334 shows the finished cannon. The stripwood cart which the cannon rests on must be made to fit the mantle-box; the shafts *a* may be straight or curved. Round holes may be cut at *b*. This same cannon may be fitted with axles, and swing between two posts. The wheels should be

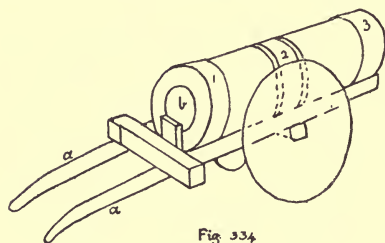

Fig. 334

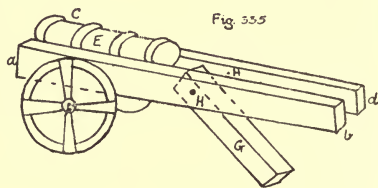

Fig. 335

painted black, and the mantle-box covered with black paper, with bands of yellow paper at 1, 2 and 3.

Toward the end of the fifteenth century artillery was much improved.

Fig. 335 shows a gun that is interesting to make.

The carriage consists of two pieces of stripwood, $\frac{1}{2}$ " \times $\frac{1}{4}$ " \times 8" (*ab* and *cd* in Fig. 335). A cannon, *E*, is made out of a roll of brown paper, length $3\frac{1}{2}$ inches, diameter about $\frac{3}{4}$ inch, and glued between *ab* and *cd*, or it may simply rest on cross-pieces of wood joining *ab* and *cd*. *G* is a piece of wood, $\frac{1}{4}$ " \times $\frac{3}{4}$ " \times $3\frac{1}{2}$ ", turning on a pin or piece of wire, *H*, which passes through *ab* and *cd*. *ab* and *cd* are glued to a piece of stripwood *F* ($\frac{1}{4}$ inch by $\frac{1}{4}$ inch) which has its projecting ends rounded to receive two cardboard wheels. The great fault of these earlier cannons was that though they were often of immense bore and weight, throwing balls of from one to five hundredweights, they were for the most part without carriages, and therefore very difficult to move about and very slow in their operations.

The Scots were the first to anticipate the modern gun-carriage by what they called 'carts of war,' which carried two guns. Many of the guns of the English required fifty horses to drag them!

'Mons Meg' (a fifteenth-century cannon still to be seen at Edinburgh Castle) is an easy model to make.

Parts A and B (Fig. 336) are drawn on cardboard, cut out and coloured (brown and black). They are joined together by strips

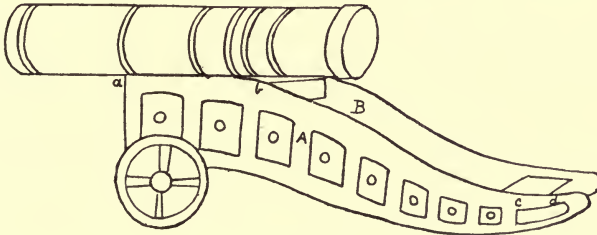

FIG. 336

of cardboard at *a b* and *c d*. To the cardboard at *a b* the cannon is gummed. The wheels are of cardboard, the axle of stripwood ($\frac{1}{4}$ inch by $\frac{1}{4}$ inch). Mons Meg fired a granite ball weighing 300 lb.

A Tudor Cannon (Fig. 337). The sides A A may be cut out of cardboard or, better still, of three-ply wood with the fret-saw. The wheels are solid discs and may also be cut out with the fret-saw, holes being drilled in the centre for the axle. The cannon itself can be shaped out of wood with pen-knife and file, or a cardboard roll (such as is used for transmitting music or pictures) can be used, the thicker parts are then made by gumming additional pieces of cardboard round it, or glueing strips of lead.

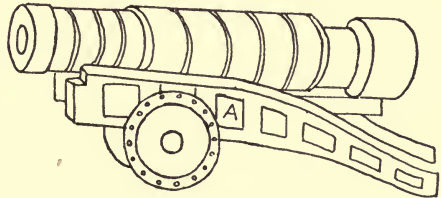

FIG. 337

It is difficult to discover when gunpowder was first used. Probably its use was learnt from the Saracens in the fourteenth century.

Roger Bacon (? 1214-1294) suggested that it might be used in warfare.

In a Florentine document of 1326 mention is made of the use of gunpowder in Europe. The first use of the cannon recorded in English history is in 1327, when Edward III was at war with Scotland.

In making the guns described in this chapter it is necessary to distinguish between breech-loading cannons and muzzle-loading.

The breech-loader is loaded from the breech or rear end of the barrel and not at the muzzle. Figs. 334, 335 and 337 are examples of this kind and therefore must have a hole at each end.

Figs. 331 and 332 are examples of muzzle-loading cannons and therefore have holes only at one end.

During the sixteenth century breech-loading was gradually abandoned for muzzle-loading owing to the large escape of gas and air at the breech. It was not until 1860 that it was reverted to with great improvements.

A Ship Cannon. A piece of wood (about $\frac{1}{4}$ inch thick, the side of a wooden chocolate-box or any other light box will do) is first

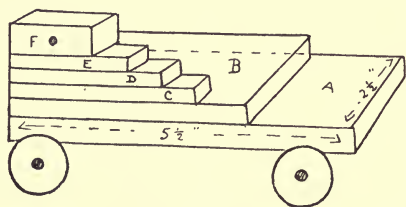

FIG. 338

sawn out $5\frac{1}{2}$ inches by 2 inches (A in Fig. 338). Another piece of wood, B, $4\frac{1}{2}$ inches by 2 inches, is cut and glued on the first piece. Three pieces of stripwood $\frac{1}{4}$ inch by $\frac{1}{2}$ inch, C, D, E, are cut to lengths $3\frac{1}{2}$ inches, $2\frac{3}{4}$ inches, 2 inches respectively.

These are glued on one side as in the figure, and similar strips are cut and glued to the other side. Two pieces of stripwood, F, $\frac{1}{2}'' \times \frac{1}{2}'' \times 1\frac{1}{2}''$, have holes drilled half way through them, to receive the pivots of the gun, but must not be glued on to E until the gun is in position.

The cannon is made of a roll of brown paper 6 inches long; one end should be narrower than the other (the widest end say 1 inch in diameter, the narrowest end $\frac{1}{2}$ inch to $\frac{3}{4}$ inch).

The roll must be securely fastened together by seccotine, two layers of brown paper make a strong cannon; black paper is then pasted over it and bands of brown paper as in Fig. 339. A hole is pierced through the cannon about half-way along it, and a round stick, K M, passed through; this pivot should be just long enough to fit into blocks F when these are fixed and glued in position.

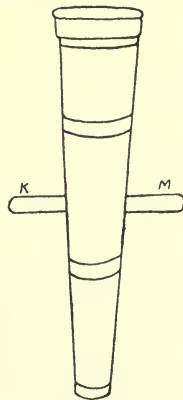
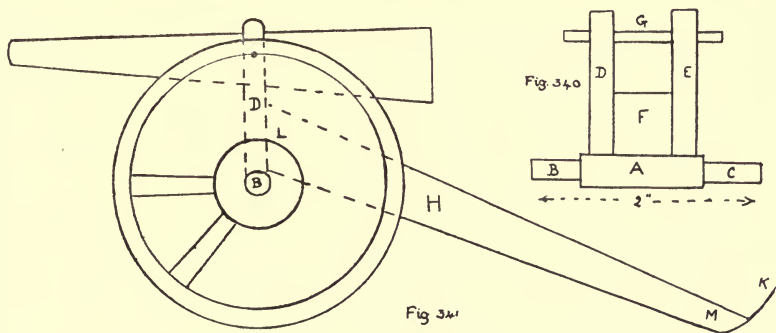

FIG. 339

Before this is done, the wheels should be made and fastened on.

This is an easy matter. Two lengths of stripwood ($\frac{1}{4}$ inch by $\frac{1}{2}$ inch) are cut $2\frac{1}{4}$ inches long. The little wheels ($\frac{3}{4}$ inch in diameter) are cut from any round rod available, or if no rod can be obtained they may be cut out of cardboard. Holes are drilled in the wheels and nails with large heads passed through and driven into the stripwood. The axles are either glued or nailed to the bottom of A. Finally the pivot, κ M, is fitted into its blocks, and these are glued into position. A wedge can be made to slip in under the cannon to raise and lower it. The wedge should be just wide enough to slip in between the two layers of stripwood.

A Modern Breech-loading Field Gun (Fig. 341). This is a simple toy to make. A piece of stripwood, A, $\frac{1}{4}'' \times \frac{1}{4}'' \times 2''$, must first be cut, and the ends, B and C, rounded for about $\frac{1}{2}$ inch (Fig. 340). Next two pieces of stripwood, D and E, $\frac{1}{4}'' \times \frac{1}{4}'' \times 1\frac{1}{4}''$, are cut. These must have their tops rounded as in Fig. 341, and have



holes drilled through them to receive a rounded match, G. F is a piece of wood $\frac{1}{2}'' \times \frac{1}{4}'' \times \frac{5}{8}''$. Pieces F, D and E are glued or nailed to A. Before the pivot G is put in position the cannon must be made. This is a roll of black paper, $3\frac{3}{4}$ inches long, $\frac{1}{2}$ inch in diameter at widest end, and $\frac{1}{4}$ inch at the narrowest. Holes are made through it to receive the pivot. The ends of the match sticks that project beyond D and E can be cut off. Next the wheels are cut. These may be cardboard discs of diameter $1\frac{3}{8}$ inches.

A piece of wood, H, is next cut, $\frac{1}{2}'' \times \frac{1}{2}'' \times 4\frac{1}{2}''$, and worked to the shape shown in Fig. 341. The end L must be sawn at an angle, so that when H is glued on, D is perpendicular. The end L is

glued to the piece of wood, *F*. *K* is a piece of cardboard with a hole through it for pulling the cannon along ; it is glued to end *M*.

The wheels, etc., should be painted black or grey. The cannon itself may be made of white paper and painted grey or yellow, or else made of yellow or light brown paper.

A Cart must next be made to carry ammunition for the cannon. The shells for the cannon described would be about $2\frac{1}{4}$ inches long, so the cart must be $2\frac{1}{2}$ inches long, and $1\frac{3}{4}$ inches wide (Fig. 342). It can be made of wood or cardboard. Notice the end to which the lid is attached.

The wheels must be the same size as those used for the cannon and can be made and attached in the same way to an axle, but

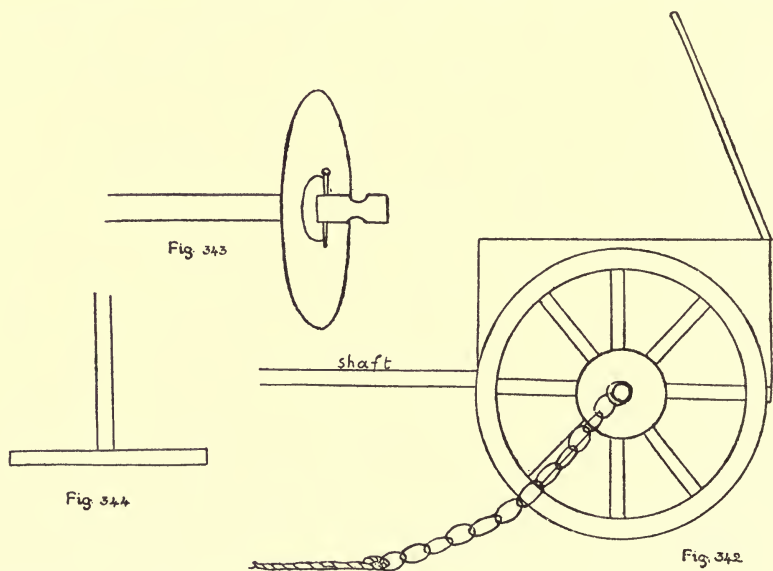

this axle must project some distance beyond the wheel, as in Fig. 343, and have a groove filed round it, so that short chains may be fastened on each side ; ropes are attached to these chains to allow the cart to be pulled along by hand.

Fig. 344 shows the shaft. It is $1\frac{1}{2}$ times the length of the cart. It can be made of strips of cardboard or wood. Matches painted black make good shells.

CHAPTER IX

A FIRE-ESCAPE (PLATE XIV)

To make this toy, plenty of used matches are required, and some strips of light wood (that obtained from a soap-box or chocolate-box will do) and liquid glue.

Two lengths of wood, Q R and S T, are cut $12\frac{1}{2}'' \times \frac{1}{2}'' \times \frac{1}{4}''$, and one long edge of each is rounded. These pieces are sand-papered if they are rough or uneven.

Twenty-three pencil dots half an inch apart are marked down the middle of the widest side of one piece. The two pieces are then clamped together (the piece with the 23 marks on top), and holes drilled through them both together with an Archimedean drill.

Next seventeen matches are taken, and cut exactly to the length $1\frac{3}{4}$ inches; the ends are tapered so that they will fit in the holes drilled. Beginning from one end of one long strip, hammer these matches in the first seventeen holes, place the second long strip of wood on top of these matches, so that the first seventeen holes are exactly over the seventeen matches and hammer it on. (Be careful to hammer in between the holes, a file makes a good hammer.) Hammer first one strip, and then the other until the matches are driven firmly in the holes, as far as they will go; file away all projecting ends of matches. Through the eighteenth hole of Q R and S T, a long piece of wood, A B, must pass to project $1\frac{1}{8}$ inches on each side of the ladder (Fig. 345).

Two pieces of wood, $3\frac{1}{2}'' \times \frac{1}{2}'' \times \frac{1}{4}''$ (C D and E F), are cut, and have six holes drilled in them; these six holes must be marked off from the six remaining holes in the main ladder, so that they will come exactly opposite them; these pieces are secured to the main ladder by matches, and by the cross-piece, A B. The whole ladder is then glued to a strip of wood, G H, $\frac{1}{2}$ inch by $\frac{1}{4}$ inch of a length equal to the total width of the ladder. This can be put aside for a time.

Next the shaft in Fig. 346 is made. $K P$ is the same length as $G H$ in Fig. 345 and about $\frac{1}{4}$ inch by $\frac{1}{4}$ inch; $K M, L N, O J, P U$ are each $4\frac{1}{4}$ inches long, they are the same distances apart as $C G, Q R, S T$ and $E H$ in Fig. 345. They are held together by strips, v, w, x, y, z . These strips may be matches; in this case they must be inserted first, and then the whole of $K M P U$ is glued to $K P$.

This shaft is fastened to the main ladder in Fig. 345 midway

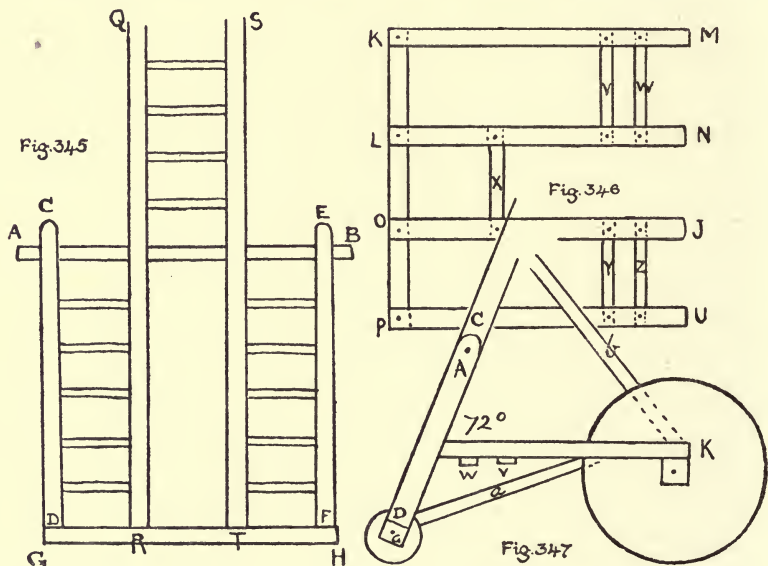

between $A B$ and $G H$, so that when the shaft is horizontal the main ladder makes an angle of 72° with it.

Fig. 347 shows the shaft $M K, P U$, attached to the main ladder; it is supported in its place by four struts, two on each side (a and b in Fig. 347). Care must be taken to saw off the ends M, N, J, U (Fig. 346) so that they rest exactly against $C D, R Q, S T, E F$ (Fig. 345), at about an angle of 72° . The ends of the struts must also be carefully bevelled to fit; the main ladder can then be glued to the shaft and the struts to the main ladder and shaft.

Small wheels of cardboard or wood are nailed (as for ship's cannon) at each end of $G H$.

An axle for the larger wheels must be made to be glued on $K P$ (Fig. 347). Care must be taken in deciding on the size of the large



wheels, the diameter must be such a length that the shaft, $\kappa \text{ M P U}$, is parallel to the ground.

Next the back portion shown on the plate is made similarly to the shaft shown in Fig. 346. It is glued to G H so as to be at right angles to the main ladder. Pieces of wire bent and pushed into holes in C D and E F form railings. Pieces of stout thread are attached to strengthen the whole, as shown in the plate. An extra ladder (necessarily narrower) can be made to rest on the bar, x , and lean inside a piece of bent wire as shown. The wheels can be made of cardboard or sawn from any of the materials suggested in Part I, Chapter XIII.

Note.—In making the fire-escape it will be a help to cut out two cardboard angles of 72° , these help to keep the shaft $\kappa \text{ M P U}$ in the right position while the glue is drying.

CHAPTER X

CASTLE, TOURNAMENT, AND FAIR

A Castle (Plate XV). Fig. 348 is an example of a mediæval castle and is somewhat similar to the Castle of Chaluz, which was besieged by Richard I. It is made of cardboard of medium thick-

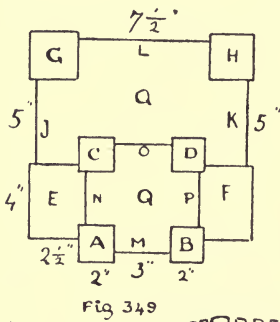

Fig. 349

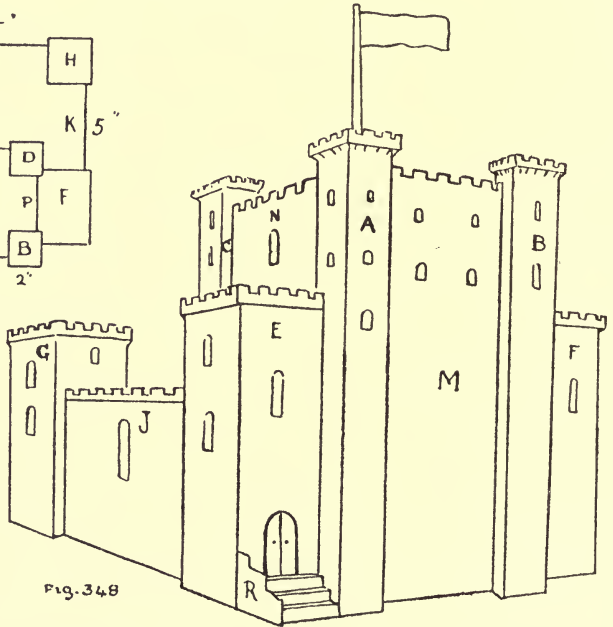

Fig. 348

ness. First make the four towers, A, B, C, D, Fig. 349. Cut a piece of cardboard 10 inches by $8\frac{1}{4}$ inches.

Divide this as in Fig. 350, and make half cuts along the dotted lines. Cut out the windows. Fold and gum together. Make the other towers in the same way.

To make overhanging battlements, cut pieces of stripwood

$\frac{1}{2}$ inch by $\frac{1}{4}$ inch the correct length, and glue them round the tops of the towers (Fig. 351). Then cut out pieces of cardboard as in Fig. 352, and gum these to the wood. It is best to cut a strip of cardboard long enough for two sides only, and to make a half cut at the bend; then to cut another strip for the other two sides. Small pieces can be cut off a length of stripwood, $\frac{1}{4}$ inch by $\frac{1}{4}$ inch, and glued underneath, as *a*, *b*, *c*, in Fig. 351.

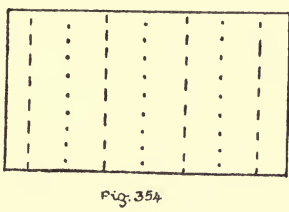
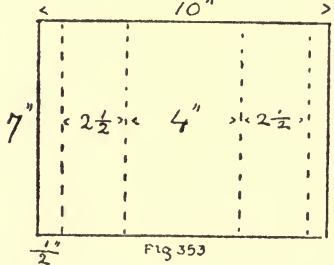
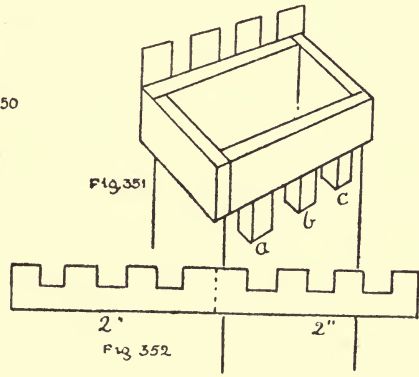
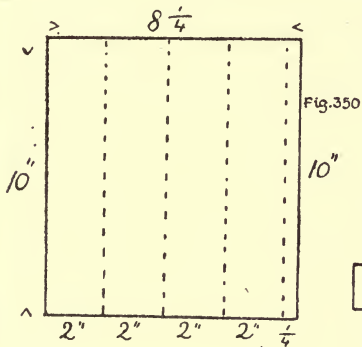

Next make the sides, *m*, *n*, *o*, *p*; these are about 3 inches in width, but a $\frac{1}{2}$ inch must be allowed on each side for flanges for fastening them to the towers; in height they just reach the battlements of the towers. Make battlements as described, cut out the windows and fasten these sides to the four towers. Colour this part suitably. To make a flat roof for *q* (Fig. 349), cut eight lengths of stripwood $\frac{1}{4}$ inch by $\frac{1}{4}$ inch just long enough to come about $\frac{1}{2}$ inch below the battlements of the sides, *m*, *n*, *o*, *p*, and glue these into the eight corners of *q*. Cut a piece of cardboard to fit over *q*, cut doors in this for access to the roof, and glue it to the tops of the pieces of stripwood.

To make towers E and F. Cut a piece of cardboard, 7 inches by 10 inches. Mark it out as in Fig. 353, and make half cuts along the dotted lines; the narrow strips at each end are flanges for fastening the tower E, to A and C. Make battlements round the top, colour, mark the windows and door, and gum to A and C; make F in the same way. G and H are similar towers $2\frac{1}{2}$ inches square and 7 inches high. The four towers, E, F, G, H, can be covered with roofs in the way already described. G and H are fastened to E and F respectively, by pieces of cardboard 5 inches long and about $4\frac{1}{2}$ inches high. G is fastened to H by L, which is about $7\frac{1}{2}$ inches long and $4\frac{1}{2}$ inches high. A door can be made in L, leading into the courtyard, Q.

Cut a piece of cardboard, R in Fig. 348, about $2\frac{1}{2}$ inches high, and gum it to the side of E to form a wall; between the latter and tower A fit a flight of steps. These are marked out as in Fig. 354.

Make half cuts along the lines marked - - - -; turn the cardboard over and make half cuts on the other side along the dotted lines; bend in alternate directions. Flanges may be added to each step.

A Tournament (Plate XV). Fig. 355 shows a royal tent at a tournament. The platform inside may be made of 12 match-boxes (A, B, C, D, E, F show the six foremost ones) or of any suitable cardboard box. Pieces of cardboard, G H K L and M N O P, are gummed on each side. *a b c d* is a piece of cardboard gummed to a match-box and placed in front of the opening between H L and M O. Paper steps may be made to lead from the ground to the top of the match-box, and thence to the top of the platform.

The roof, S, is a piece of paper, bent along T V, to fit the triangular tops of the cardboard sides, Q and R, to which it is fastened by paper hinges. A piece of cardboard is gummed at the back. Flags, etc., may be added.

X and Z show stands at the back for the more ordinary spectators. They are simply strips of cardboard, suitably painted and gummed for support to match-boxes or strips of wood.

The railings shown in the plate are made of cardboard or strip-wood, and placed in suitable positions to represent the lists. If the railings are made of cardboard they should be fitted into a groove in a piece of wood to enable them to stand.



CASTLE AND TOURNAMENT



Across the enclosed space, and parallel to the royal tent, a partition is placed to separate the combatant knights. It may be made of cardboard or wood (see Fig. 356).

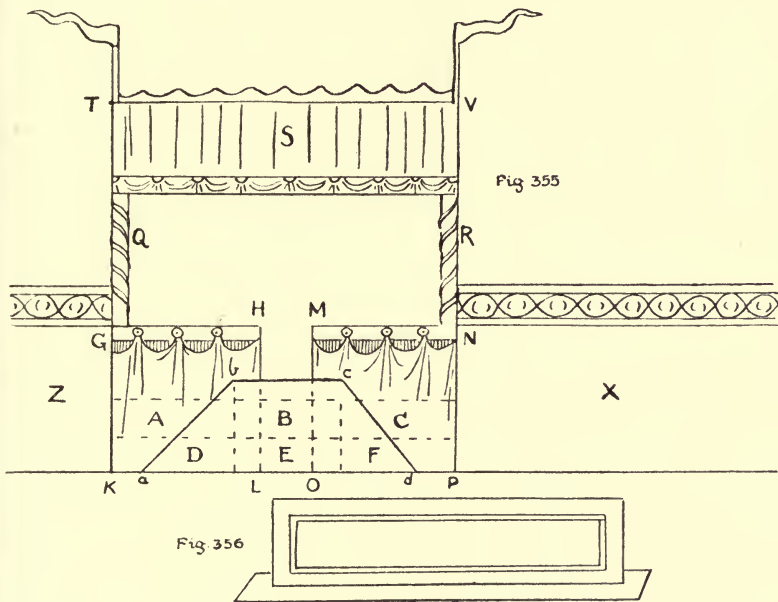

Two circular tents made of cardboard and paper stand at each side; in these the knights put on their armour.

In Fig. 357 A is a cardboard disc to which the paper covering c is gummed by a flange; B is a post which is glued into a hole in the middle of the cardboard disc and rests on the ground inside the tent.

The horses are made of corks and matches as described in previous chapters. A piece of coloured paper (A in Fig. 358) is gummed over the horse's back. The saddle, B, is a piece of coloured paper, gummed to A. The bridle is cut out of paper.

Knights may be cut out of paper as in Fig. 359. Two pieces of paper should be cut out, of the same shape except that one arm bears a lance, the other a shield; gum the head and upper part of the body together; the knight can be fastened to the horse by gumming his legs to the trappings, A.

Heralds, a king and queen to sit in the royal box (for which a bench must be made), spectators, etc., may be drawn and cut out, or suitable figures can sometimes be cut from old history books

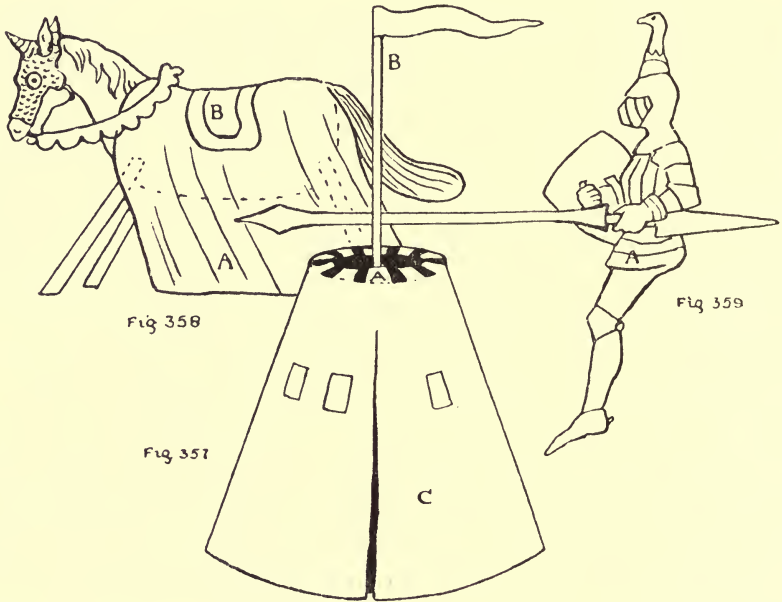

or advertisements. The background may consist of trees or of a castle. In a similar way, with cork horses, etc., a procession of the Canterbury pilgrims can be made.

A Fair in the Days of Henry VIII (Plate XV). The plate shows the background of the fair. It is a piece of cardboard, with houses drawn upon it and coloured; behind it are fastened two cardboard supports which enable it to stand upright. This piece of cardboard should be as long as possible, to give plenty of room for many booths to be placed in front of it. Fig. 360 shows a booth at which cloth and woollen materials are sold.

The covering of the booth is made of paper. The tables may be of different shapes in different stalls. In the cloth merchant's stall, rolls of coloured paper are piled up to represent bales of cloth. To the pole is tied a sheep cut out of cardboard. An apothecary's booth with its red and white pole can be made.

Shelves of cardboard, supported on little pieces of wood glued to the posts of the tent, may be fastened round three sides of the

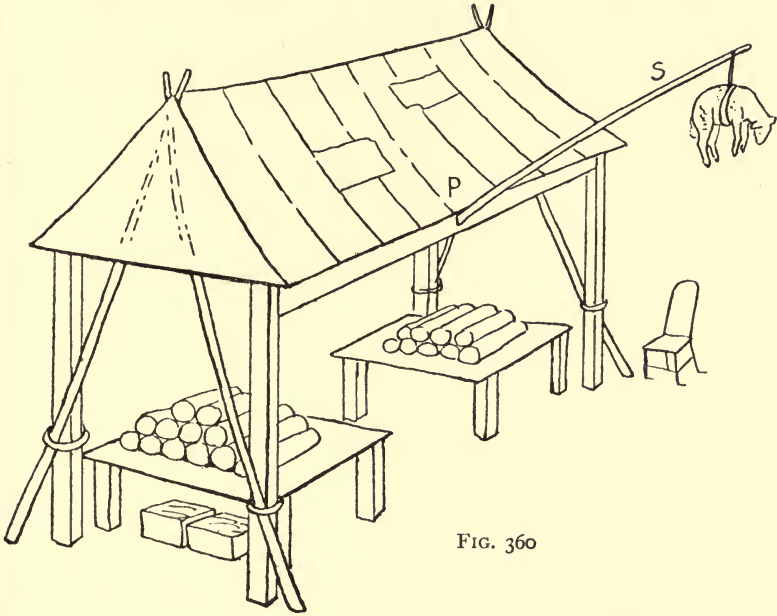

FIG. 360

booth ; cardboard bottles are cut out, painted and fastened to the shelves by paper hinges, or bottles can be made of plasticine.

Other booths may be added, one for 'ribbons of all the colours of the rainbow,' others for books, leather, ironmongery, pewter and silver articles for the table, etc.

CHAPTER XI

AN OLD CHARIOT AND SOME QUAIN'T DOLLS' FURNITURE

FIG. 361 shows a quaint swinging chariot of the eleventh century ; it can be made of stout cartridge paper, cardboard and stripwood ($\frac{1}{4}$ inch by $\frac{1}{4}$ inch).

First draw on cartridge paper two arcs of a circle (about

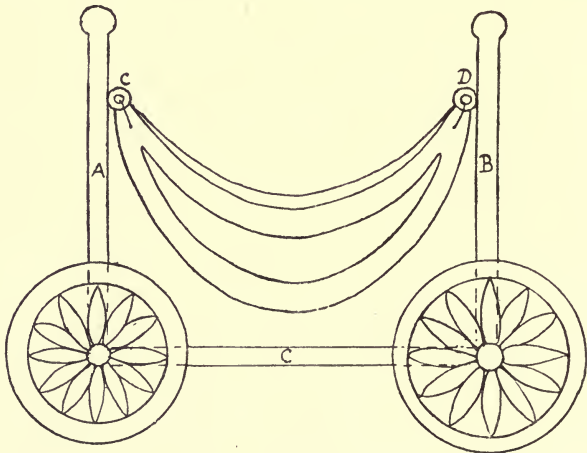

FIG. 361

3-inch radius), *a b c* and *d e f* in Fig. 362 ; join them by straight lines *a d* and *c f*. This is for the floor of the chariot.

To make the sides, draw arc *g h k* (Fig. 363) with same radius, but portions *g l* and *m k* project about 1 inch beyond the arc *a b c* in Fig. 362. Join *g* and *k* by the curved line, *g n k*. Draw the flange *o p*. Colour the side yellow and brown, cut out. Bend the flange *o l m p* and gum it to *a b c* in Fig. 362. Draw and cut out the other side in a similar manner and gum it on ;

the chariot will then appear as in Fig. 361. Two seats of paper can be gummed inside.

Two pieces of stripwood ($\frac{1}{4}$ inch by $\frac{1}{4}$ inch), A and B in Fig. 361, are then cut; their height must be determined by the size of the

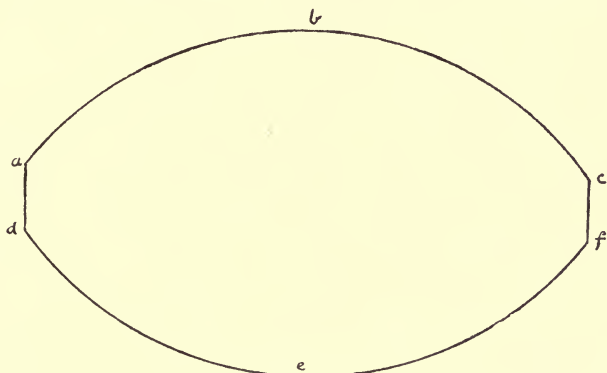

FIG. 362

car. Two small screw-eyes are screwed in at c and D (Fig. 361), from which the car is slung by pieces of thread or wire. The posts, A and B, are glued and nailed to the middle of the axles, which must be flat, the ends only being rounded for the wheels.

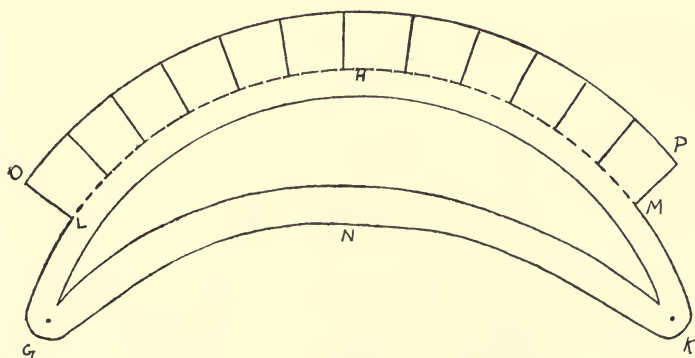

FIG. 363

Pieces of stripwood ($\frac{1}{4}$ inch by $\frac{1}{4}$ inch) or strips of cardboard, c, connect the axles on each side.

The wheels are cardboard discs, with a pattern drawn on them as in the figure, and painted yellow and brown.

Fig. 364 shows a pretty chair for a doll's house. It is a copy of a carved oak chair of the fourteenth century. It is made of wood or cardboard. If made of cardboard, a small square box, A, to which the sides and back are gummed. The sides and back should be cut in one, with half-cuts down *a b* and *c d*, where the cardboard is bent and gummed to

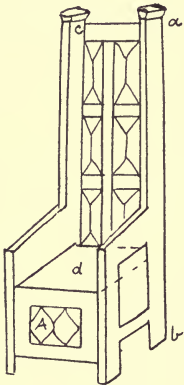

Fig. 364

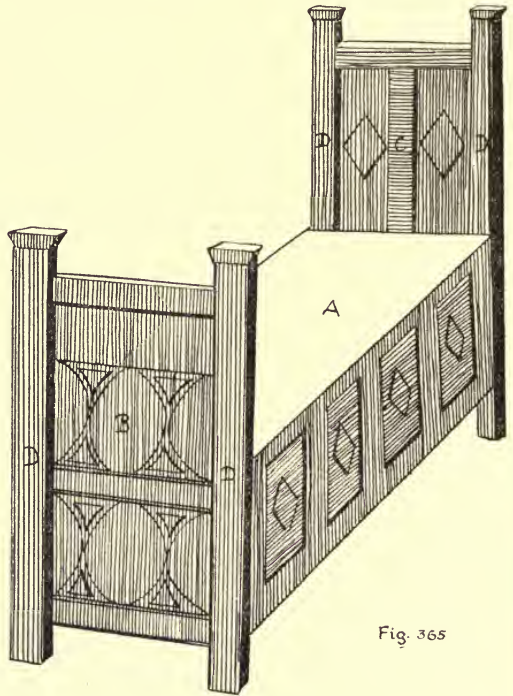

Fig. 365

the box. The chair should be painted a very light brown with dark brown markings. It looks well if made of the wood of a cigar-box.

Fig. 365 gives a pattern of a fourteenth-century bed that goes with the chair. A can be an oblong box, covered with paper suitably coloured (light brown with panels of dark brown). B and C are pieces of cardboard (painted as indicated) gummed to each end of the box; four pieces of stripwood, D ($\frac{1}{4}$ inch by $\frac{1}{4}$ inch), are glued on to the cardboard.

This bed is easily made of wood. A may be a cigar-box, or the bed can be made of separate pieces of wood carefully glued and nailed together.

A Fire-place (Fig. 366). This toy is made of wood and cardboard. Its size will depend upon the doll's house for which it is made. The mantelpiece, D, is a piece of wood glued and nailed to two wooden supports, E and F. To the back of these a piece of cardboard, A, is glued. This is coloured to look like tiles, and space c is painted black. The grate is made of cardboard

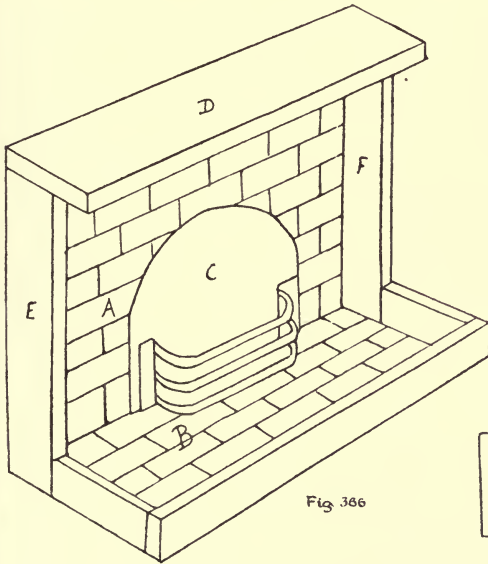

Fig. 366

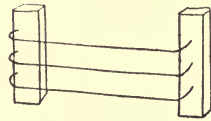

Fig. 368



Fig. 369

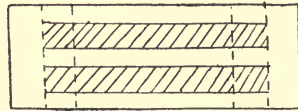

Fig. 367

(Fig. 367). The shaded portions are cut out and half cuts are made along the dotted lines. It is coloured black, bent as in Fig. 366 and gummed to the cardboard back. The fender is of wood, and is glued to E and F and to a cardboard bottom, B, which is coloured to represent tiles.

The grate may also be made of pieces of wire bent to shape and passed through holes in two pieces of wood (Fig. 368), which are then gummed to A.

Fire-dogs can be made from matches glued together as in

Fig. 369. A poker and shovel can be cut from cardboard. The most convenient sizes of stripwood from which to make this toy are lengths of $\frac{1}{2}$ inch by $\frac{1}{4}$ inch for supports E and F, lengths of $\frac{1}{4}$ inch by $\frac{1}{4}$ inch for the fender, and 1 inch by $\frac{1}{4}$ inch for the mantelpiece.

CHAPTER XII

RAILWAY SIGNAL AND SIGNAL-BOX

A Railway Signal. Fig. 370 shows a simple method of making this toy. A is a piece of stripwood about $11'' \times \frac{1}{2}'' \times \frac{1}{4}''$, fastened to a wooden stand. Holes are bored in A at F about $\frac{1}{2}$ inch from the top

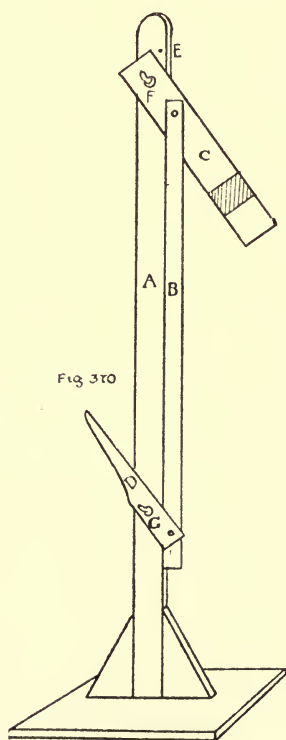

Fig. 370

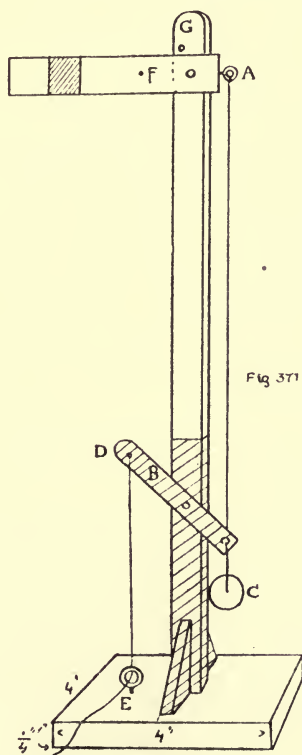

Fig. 371

and at G about $2\frac{1}{2}$ inches from the ground. The arm, c, is a piece of cardboard 3 inches by $\frac{1}{2}$ inch with a red band painted across it.

The lever, *D*, is a smaller piece of cardboard. *C* and *D* are fastened to *A* by pieces of wire or by rivets so that they move freely up and down. *B* is a narrow strip of stiff cardboard fastened by small paper-clips to *C* and *D*. When the lever, *D*, is pulled down, the arm, *C*, is pushed up. A small nail is put in at *E* to keep the arm from rising too high.

Fig. 371 shows a railway signal which can be worked by a lever placed at any distance away.

In this model the arm, *F*, is a piece of wood about $4'' \times \frac{1}{2}'' \times \frac{1}{4}''$. Into one end is fixed a screw-eye, *A*. About $\frac{1}{2}$ inch from this end bore a hole. Nail the arm through this hole to the post about $\frac{3}{4}$ inches from the top, so that it moves freely on the nail. *B* is a piece of wood, $2'' \times \frac{1}{2}'' \times \frac{1}{4}''$. Make three holes in it. Nail it through the middle hole to the post, 3 inches from the ground, so that it turns freely on the nail. Take a piece of fairly strong wire, fasten one end to *A* and the other to *B*. A weight (a lead button) is needed to keep the arm of the signal up. Attach this weight, *C*, by a piece of thread to *B*, as in the figure. Tie a piece of thread to *D*, pass it through a small screw-eye, *E*, fixed on the stand. When this string is pulled the arm is lowered.

This toy may be worked entirely with thread. Tie a piece of thread from *A* to *C*, taking care to keep the lever *B* in the position shown in the figure; then tie another piece from a small nail at *F* to *D*. A small nail should be put in at *G* to prevent the arm from rising too high.

The stand and the shaded part of the signal post should be painted black, the rest of the post is white, the arm is white with a red band.

A Signal-box (Plate VIII). For the foundation of the signal-box, take a piece of wood 9 inches by 4 inches, *A B C D* (Fig. 372). Cut two pieces of wood, $4\frac{1}{2}$ inches by 4 inches. Glue and nail these to *A B C D* (*E* and *F* in Fig. 372). Next cut four pieces of wood, *G H J K*, $\frac{1}{4}'' \times \frac{1}{4}'' \times 6\frac{1}{2}''$. Glue these to *E* and *F*. Measure and cut two pieces of wood, *M* and *L*, to fit in between *K* and *J*, and *G* and *H*. Glue these in position. Next measure and cut out a piece of cardboard, *N* (Fig. 374), that will fit in between the posts, *G H J K*, and rest on the sides, *E* and *F*, and the ends, *L* and *M*. This forms the floor of the signal-box.

Measure and cut two pieces of cardboard that will fit across

the space between the posts G and K. Mark and cut out windows in these as shown in the plate, and glue them on each side to the posts. Next cut out two pieces of cardboard, 9 inches by 4 inches (Fig. 375). Measure along the sides the distances C J and K B; find the middle, O, of top, join O K and O J, and cut off the shaded portions. Make half cuts along the dotted lines and bend back the flanges to which the roof is fastened. In one piece make a

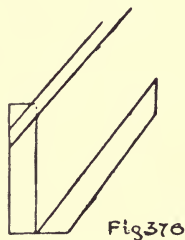
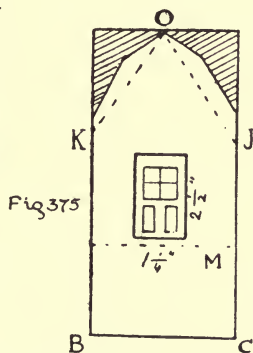
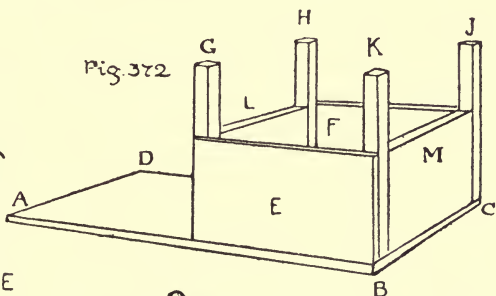
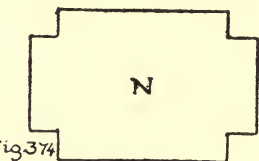
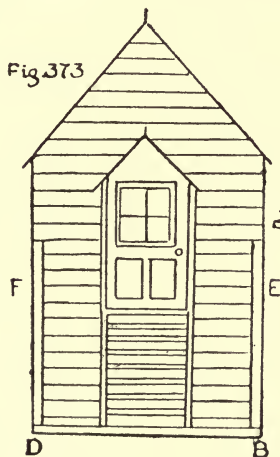

door, the bottom of which must be on a level with the floor. A window may be cut out in the door, or simply drawn in with pencil and painted; on the other side, mark and cut out a window similar to the window in the sides. Glue these pieces in position. Make the roof of cardboard as described in the case of the Noah's Ark, and glue it to the flanges.

The Porch. For the platform of the porch cut a piece of wood $1\frac{3}{4}$ inches by $1\frac{1}{4}$ inches. Cut two sides, $2\frac{3}{4}$ inches by $1\frac{1}{4}$ inches. Glue and nail these to the platform. Cut two supports as shown in the plate, and glue these to the ends just underneath the door, so that when the porch rests on them, and the door is

open, the floor of the porch is level with the floor of the signal-box. Next cut the two outer posts, glue them into position as shown in the plate, and glue the platform of the porch on the four posts. The roof of the porch is cut from cardboard, with flanges to be glued to the end of the signal-box. The slope of the roof should be parallel to that of the roof of the signal-box.

Make a ladder as described in Chapter IX. Bevel the ends of the ladder as in Fig. 376 so that it can be glued into position. Glue two small posts on each side and glue two strips of cardboard to these and to the sides of the porch for railings.

Windows may be painted in the wooden sides, the rest is coloured to represent bricks; the window sashes are dark green or brown, and the roof grey.

From this signal-box the signal shown in Fig. 371 can be worked in a very simple manner. Fig. 377 shows the arrangement.

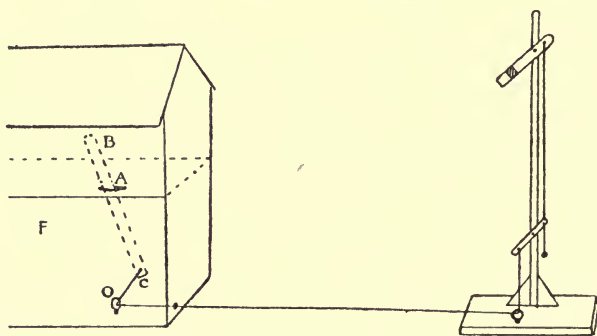

FIG. 377

Through a hole, A, in the floor fits a wooden lever, B C. Pass the thread belonging to the signal through a small hole in the side of the box, then through a small screw-eye at O, and tie it to the end of the rod. When the lever, B, is pushed over the signal arm is lowered.

A small nail is put through the lever just above A, to act as a fulcrum. The side F (Fig. 377) may have large windows which open to enable the child to insert his hand and push the lever. If the signal-post is set up some distance away from the signal-box, it may be found necessary to add another weight.

CHAPTER XIII

LIGHTHOUSE, TRANSPORTER BRIDGE

A Lighthouse (Plate XVI). This lighthouse is similar to one called the Gull Island Light in Newfoundland. It is a hexagonal column and is therefore somewhat easier to make than a circular structure.

The main column is 9 inches high, and each of the six faces is 2 inches. Cut out a piece of cardboard, of medium thickness, 9 inches by $12\frac{1}{4}$ inches (Fig. 378).

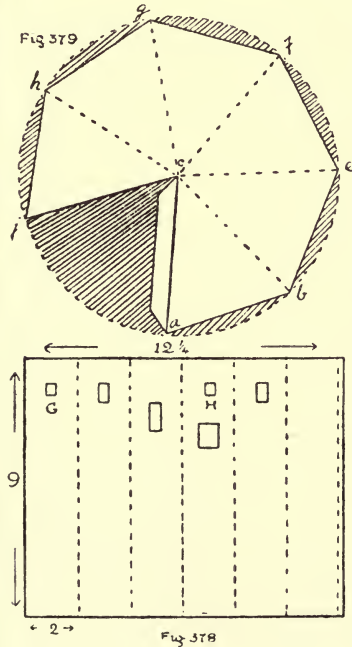

9 inches by $12\frac{1}{4}$ inches (Fig. 378). Divide it into six parts 2 inches in width, leaving a flange $\frac{1}{4}$ inch wide at the end for fastening the column together. Make half cuts along the dotted lines. Cut out a door and windows, and two holes, G and H, $\frac{1}{4}$ inch square. Fold and gum together. The hexagonal column above the first platform is $2\frac{1}{2}$ inches high, sides 2 inches; that above the second platform is 2 inches high, sides $1\frac{1}{2}$ inches.

Before folding and gumming the top column, or lantern, together, windows must be cut out. It is easier to cut the windows out completely and gum the bars behind the openings. A door is cut just above the first platform as shown in the plate. The top of the lantern is a hexagonal

pyramid $1\frac{1}{2}$ inches high, edges 2 inches. To make this, the length of one of the sloping edges (as $a' d'$ in Fig. 380) must be found.

Draw a line ab (Fig. 381) 2 inches long. This is one edge of the hexagonal base. On it make an equilateral triangle acb .

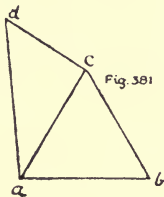
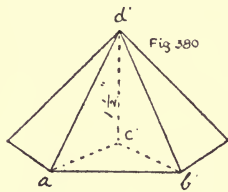

This is the same as triangle $a'c'b'$ in Fig. 380. At c (Fig. 381) draw cd at right angles to ac ; make cd equal to the height of the pyramid—namely, $1\frac{1}{2}$ inches; join ad ; this is the length of one of the sloping edges ($a'd'$ in Fig. 380). With radius ad describe a circle (Fig. 379). Mark along its circumference the distance ab , six times; join a to b , b to e , etc., and join each point to the centre. Cut off the shaded portions, leaving a flange for fastening, and make half-cuts along the dotted lines. Bend and gum together.

The first platform shown in the plate is a circle of cardboard or wood, radius 3 inches. Holes are made round the edge.

To this the upper column is fastened by paper hinges, unless the columns have been provided with flanges at top and bottom. Glue match sticks or pieces of cane, about 1 inch in length, into the holes in the platform for railings, round which black thread may be tied. Now fasten the whole to the main column so that the sides coincide.

In the same way the lantern is fastened to the upper platform and the latter to the upper column, after similar railings have been made round the upper platform. Lastly the pyramidal top is fixed on the lantern, by either paper hinges or flanges. Now cut a piece of stripwood, $\frac{1}{4}$ inch by $\frac{1}{4}$ inch, of the right length, so that it passes through the holes G and H in the lower column and projects about $\frac{1}{8}$ inch over the doorway; into this projecting end screw a small screw-eye, pass a piece of string through it and bring the ends inside the door. This is the pulley by means of which goods are hauled up from the boat into the lighthouse. A ladder can be made of matches (as described in Chapter IX); two wire hooks are inserted at the ends, and it is hung to the doorway.

The lighthouse can be coloured grey and fastened to a piece of cardboard painted blue.



A Transporter Bridge. The supports for this bridge, A and B (Fig. 382), are two small wooden Bovril boxes (those containing one dozen one-ounce tins); their bottoms have been knocked out and they are mounted on wooden supports or on two smaller boxes of about the same width.

Take two lengths of stripwood, c, D, $2' \times \frac{1}{2}'' \times \frac{1}{4}''$; on to each of these glue and nail a similar length of stripwood, $\frac{1}{4}$ inch by $\frac{1}{4}$ inch (Fig. 383). Next the overhead trolley should be made (Fig. 384). The axles G and H are about $3\frac{1}{2}'' \times \frac{1}{4}'' \times \frac{1}{4}''$. The wheels are made

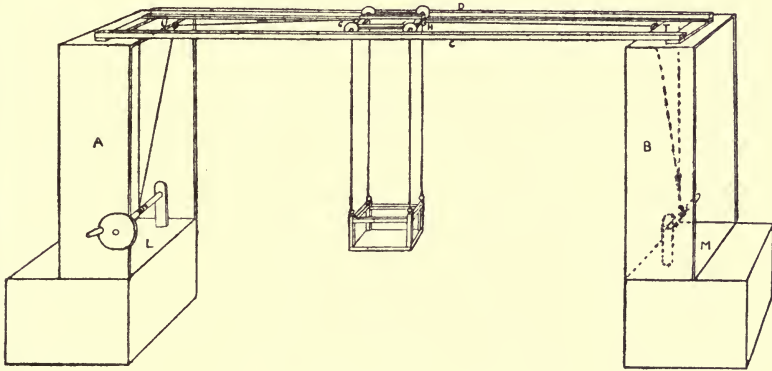

FIG. 382

of wood and can be cut from an old broom handle. Before these are put on, the two pieces E and F, which are $3\frac{1}{2}'' \times \frac{1}{4}'' \times \frac{1}{4}''$, are glued to G and H. C and D are placed so that the trolley runs easily along their ledges, the distance between them is measured and two pieces of stripwood (J in Fig. 383) are cut, by means of which C and D are fastened together. This frame can rest on A and B. There is no need to fasten it permanently.

To each end of H and G, very small screw-eyes are screwed, K in Fig. 383, to which the strings or chains which support the car are attached—also two screw-eyes are screwed in at H and G.

Fig. 385 shows part of the car and gives the necessary measurements. Side R is made of stripwood, $\frac{1}{4}$ inch by $\frac{1}{4}$ inch. The gates at each end are made of strips of cardboard. Four screw-eyes are placed in the corner posts for hanging the car to trolley (see Fig. 382). Pieces of thread are tied to the screw-eyes at H and G,

202 TOY-MAKING IN SCHOOL AND HOME

and pass through screw-eyes in the supports (r and u in Fig. 382). Two windlasses can be made to stand on m and l, similar to the

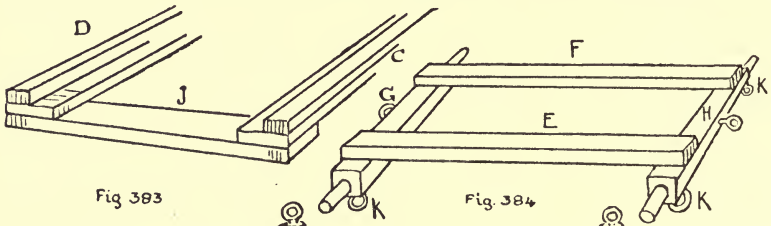

Fig. 383

Fig. 384

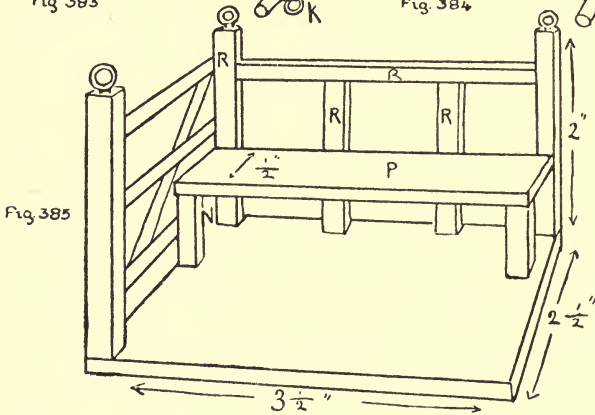

Fig. 385

winding gear described in making the crane (Chapter V), by means of which the car can be drawn backward and forward. The bridge may stand across a piece of cardboard painted to represent a river.

CHAPTER XIV

YACHTS AND BOATS; THE USE OF THE CHISEL

FOR the toys described hitherto, the chisel has hardly been required, but to carve boats from a solid block of wood it becomes somewhat of a necessity, the pen-knife being but a poor substitute. The use of the chisel has been postponed owing to the dangers which attend its use. However, when children have become accustomed to handle tools properly and to respect them, they are no more likely to cut their hands with a chisel than with a knife when sharpening pencils or peeling potatoes.

The following tools will be found useful in making exact models of boats, hollowing them out, etc. :

- (1) A $\frac{1}{2}$ -inch or $\frac{3}{4}$ -inch chisel. This is a good one to start with.
- (2) A smaller chisel about $\frac{1}{4}$ inch wide.
- (3) A gouge. A $\frac{3}{8}$ inch and a $\frac{5}{8}$ inch gouge answer most purposes. This is an indispensable tool when hollowing out a boat.
- (4) A spoke-shave. This is used to smooth a curved surface after it has been roughly cut with a chisel or knife. It is not really necessary, as its work may be done with sand-paper or a file. However it is not expensive, and it leaves the wood with a 'clean' surface much superior to that obtained with sand-paper.

(5) A vice.

The best wood for making the following boats is *yellow deal* or *American whitewood*. This, though not expensive, must be bought. One does not often find a piece of waste wood suitable for boat-making.

A very simple boat can be made in the following way. Procure a block of wood about $7'' \times 1\frac{1}{2}'' \times 2''$. On the top surface of the block draw a plan of the boat as in Fig. 387; on the bottom surface draw the plan shown in Fig. 388. Take care not to make the keel too narrow, especially in first attempts at boat-making. The keel of this boat may be quite $\frac{1}{4}$ inch thick. See that it is really in the middle.

204 TOY-MAKING IN SCHOOL AND HOME

Mark on both sides of the boat the lines shown in elevation, Fig. 386. Mark lines showing the stern elevation

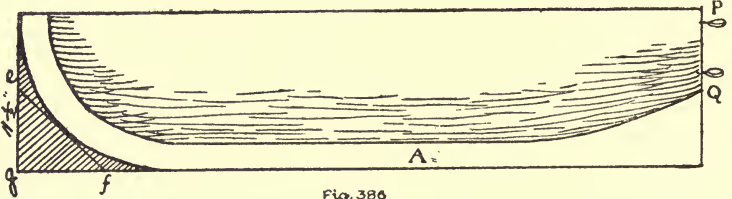

Fig. 386

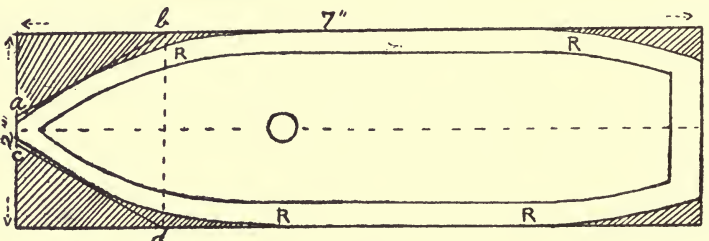

Fig. 387

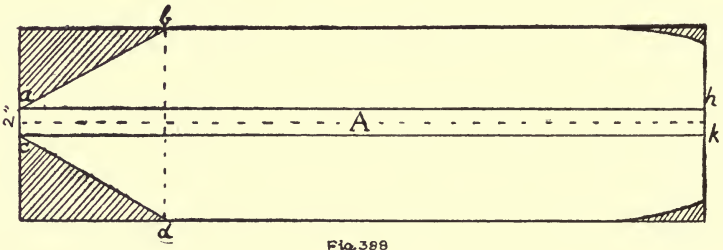

Fig. 388

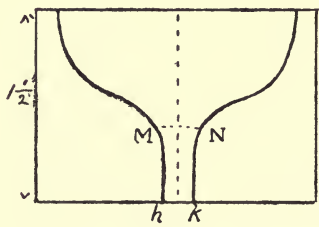

Fig. 389

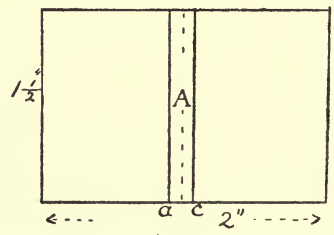

Fig. 390

as in Fig. 389, at the other end the stem, as in Fig. 390. Now saw away as much surplus wood as possible. It is well

to begin by sawing along lines *a b* and *c d* in Fig. 387, to roughly shape out bow. If a very curved bow is desired, saw off the corner *e f g* (Fig. 386). To make the keel, saw along lines *a h* and *c k*, about $\frac{1}{4}$ inch deep (Fig. 388), at the stern end saw down to *m* and *n*. Now carefully round and model the sides and keel with gouge, chisel, spokeshave and file, or simply with chisel and file.

Before finishing off with sand-paper or spoke-shave, the boat should be tried in the water, it will probably lean to one side ; cut off a little wood from this side and try again. (Be careful to dry your tools if they get wet.) When the boat is properly balanced, nail a strip of lead along the keel.

A hole may be bored on the deck for a mast.

To make the Rudder. Saw a piece of wood out about 1 inch by $2\frac{1}{4}$ inches (wood should be about $\frac{1}{4}$ inch thick). Draw a rudder on it as in Fig. 391, cut out this shape with saw and file. Round the top as at *c* for the handle. Make holes with a fine bradawl and insert two pieces of bent wire at *a* and *b*. To put them in it is best to hold them with a pair of pincers. Ordinary pins with their heads cut off do just as well as wire. Make two wire loops and fix them in the stern of the boat (*p* and *q* in Fig. 386), that the rudder may hook on to these, care must be taken that the eyes are exactly opposite the hooks. To make the tiller, drill a hole in a piece of wood, as in Fig. 392, and file it large enough to fit tightly round the top of the rudder, then work the tiller to shape.

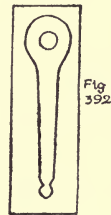
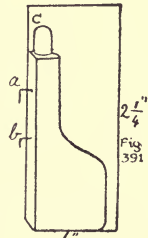

This boat can be hollowed out with the gouge. First draw line *R R R R* round the boat (Fig. 387) to give the thickness of side. Before starting on the actual boat, it is as well for the amateur to practise cutting a few hollows. With satin walnut, pine, American whitewood, gouging is not a difficult matter. When the boat is being gouged out it should if possible be placed in a vice. (Always put a piece of thin wood between the jaws of the vice and the article you wish to hold to prevent marks.) Another way of hollowing the boat is to begin boring centre-bit holes as close together as possible, being careful not to bore too deep,

then gouge out as much wood as you safely can, finish with file and sand-paper. When the boat is hollowed out, seats can be made for it. These should be cut the exact length of middle of boat, bevelled at the ends, and fitted into the boat by forcing them into position.

Figs. 393, 394, 395 show elevation and plans of a common

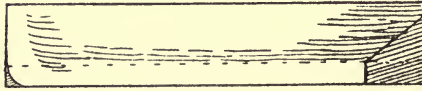

Fig. 393

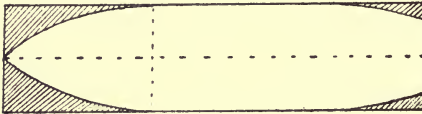

Fig. 394

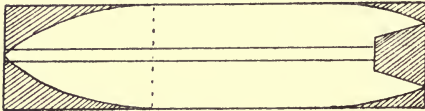

Fig. 395

type of boat. Saw off triangular pieces of wood to form the bow, cut out the stern with the tenon saw and chisel. Model the sides and keel with gouge, chisel and file as before. To put a rudder on this boat, notice that a hole must be bored through the deck for the rudder to pass through. There is no need in a boat like this, or indeed in any boat (when practice has

been attained), to saw out the keel, the gouge and chisel are sufficient, but the sawing sometimes helps the beginner.

A Schooner (Plate IV). On a suitable piece of wood (a square

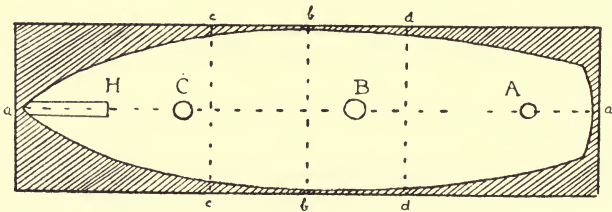

Fig. 396

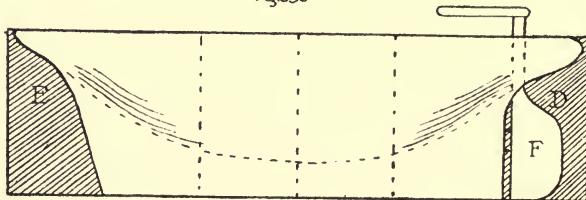

Fig. 397

prism, length $3\frac{1}{2}$ times width) draw a line *a a* (Fig. 396) on the surface through the middle from end to end. Then draw a line

across the middle $b b$, and divide the surface in three by lines $c c$ and $d d$. Pencil out the deck as in Fig. 396. Now here is a piece of advice that it is well to follow in all boat-making. To mark off the deck make a cardboard template the shape and size of one half, taken from the middle line, $a a$. Lay the template on one half of the piece of wood and pencil round the edge. Then turn the template over on the other side and pencil round the edge again. In this way the shape of the deck is more accurate and both sides are symmetrical, which is very important if the boat is to float upright in the water. Now on the sides draw the elevation as in Fig. 397.

Cardboard templates will also be found useful in getting the cross-sections correct.

Now saw and file away the stern, D , and the bow, E , and chisel away the sides and keel as described before. Fig. 398 shows the appearance of the stern.

Having chiselled and filed the outside of the hull to correct shape and exactly equal on both sides, gouge out the inside as described before. Next make the deck from deal about $\frac{1}{8}$ inch thick, cutting it the exact size of the outline in Fig. 396. Before fastening the deck, bore a hole at A for the rudder (a corresponding hole being bored in the hull), and holes at B and C for masts (with corresponding holes, not more than $\frac{1}{4}$ inch deep, in the hull). If need be (in large models) the under part of the deck where holes come can be strengthened by pieces of wood nailed across. With a hard pencil draw lines along the deck to give the appearance of boards.

A hole for a hatch-way may be cut out with a fret-saw. The hatch-way itself for a large boat can be made of pieces of wood nailed together.

Now fix the deck on to the top of the hull with small nails.

Another way of fixing the deck is to make it just large enough to fit inside the hull, leaving an edge or bulwark all round, $\frac{1}{4}$ inch to $\frac{1}{2}$ inch in depth.

The longer mast goes into hole B . The total length of the schooner is about $1\frac{1}{4}$ times the height of the mast above the deck. The shorter mast goes into hole C and is very little longer than half the boat. The masts must fit firmly into the holes in the deck and hull.

208 TOY-MAKING IN SCHOOL AND HOME

To ballast the boat, nail a piece of lead along the keel. If too large a piece is used at first, it can easily be reduced.

The rudder *F* is cut out and fixed as already described.

H in Fig. 396 shows where the end of the bowsprit comes.

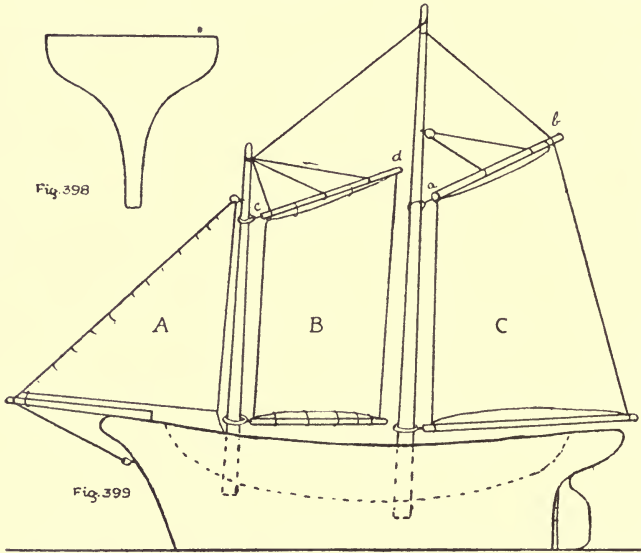

A. Stay foresail. B. Gaff foresail. C. Mainsail.

Fig. 399 shows a drawing of the masts and sails for a schooner. The gaffs, *a b* and *c d*, and the corresponding booms, are fastened to the masts by wire loops. Lawn or Indian muslin make good sails. It is well to wash the material before using it.

CHAPTER XV

THE FRET-SAW

THE Fret-saw is a delightful tool, and very useful to the toy-maker. It can be used for making wheels and the various jointed and mechanical toys described in the following chapters.

In dealing with the fret-saw we have to consider (1) the saw-blades and (2) the frame in which they are held. The saw-blades are about five inches in length and are made of delicate steel wire with correspondingly fine teeth. They are very cheap, being commonly sold at about three halfpence to threepence a dozen, and even less when purchased by the gross. They are supplied in ten different grades, numbered from 00 to 8, proceeding from fine to coarse. For the toys described in this book, Nos. 1, 2 and 3 will be found most suitable. To preserve the saw-blades from rust, keep them in a wood or metal case. Upon the proper tension of the saw-blade depends its action. To keep it taut, a number of frames have been designed, the most practical being one made of steel and varying in size from 12 inches to 18 inches measuring from the saw-blade to the back of the frame. The handle is of wood. The 12-inch size is the most suitable for children.

Cheap frames can be obtained for sixpence halfpenny (smaller ones even for fourpence). In the cheaper kinds the necessary tension is obtained by drawing the arms slightly towards each other when clamping the blade. The spring of the steel will then keep the blade sufficiently taut. In the better-class frames (price from two shillings upward) the tension is secured by the action of a lever. Notice that the saws must be inserted with the teeth pointing downward.

Holding and managing the Saw-frame. The hand saw-frame requires all the steadiness possible ; the bend of the frame should rest along the forearm, and against the shoulder if the frame be

a long one, or under the shoulder if a short one. This prevents the frame from swinging round.

The saw-blade will describe the arc of a circle as it passes through the wood, and this dip is reduced to the minimum by making *short strokes* instead of long ones. This is important to remember. The amateur is sure to break a few saw-blades at first, they are so fragile, indeed even in the hands of an expert they have a precarious hold on life and can only be expected to last a certain time. Fortunately they are cheap.

The saw-blade must not be pressed on into the wood too quickly; the wood is held to the table with the fingers, and every part of the line to be cut is moved in due succession against the cutting edge of the blade. Excessive energy will often cause the blade to stick fast in the wood; in this case the blade must be eased by gently working it up and down so that it does not cut but frees itself. This method can be adopted when turning a sharp corner; work the saw up and down (without cutting) until the blade points in the right direction.

Very often the locking of the blade in the wood is due to gummy or heavy wood, or to a twist in the saw-blade; this latter cause can be prevented by the exercise of care in fixing the saw in the frame.

Children should have the cheaper frames to practise with; however they soon learn to manage them and in due course find out that a saw-blade is really not so delicate as it looks. In cutting out animals, etc., leave a piece of surplus wood round the frailer parts as long as possible so that one has something to hold without fear of breakage.

When an interior space has to be cut out (*e.g.* when cutting away interior portions of wheels to make the spokes) a hole must be made by means of the Archimedean drill to admit the saw; the upper end of the saw is released from its clamp, passed through the hole, and again fixed in position. The hole in all cases should be bored as near as possible to a corner or point, as these are convenient starting-places. A medium-sized drill point rather than fine points should be used wherever space permits. Fine points are apt to break. The drill stock must be held quite vertical and revolved both when the point is entering the wood and when

it is being withdrawn. No pressure is required on the drill beyond its own weight.

In making the various jointed animals, etc., in the following chapters bifurcated nickel rivets are used, small-gauge. The following are useful sizes:—

Sizes No. 14 $\frac{6}{18}$, $\frac{8}{18}$, $\frac{10}{18}$. (These are useful for jointed animals.)

Sizes No. 11 $\frac{12}{18}$, $\frac{14}{18}$, $\frac{16}{18}$. (These are used for the crane, etc.)

These rivets can be bought in boxes of assorted sizes.

Figs. 400 and 401 show how a jointed animal is riveted together. When hammering the rivet open, its head should be



Fig. 400

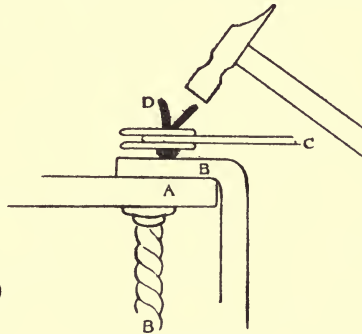

Fig. 401

placed on a piece of metal (the clamp will do). Fig. 401 shows the method of opening the rivet. A represents the table, B the clamp, C the head of the rabbit and its ears, D, the rivet.

CHAPTER XVI

LITTLE GYMNAST; DANCING CLOWN; ROCKING ANIMALS

Little Gymnast. First the little gymnast must be drawn and cut out. He can be made of cardboard of medium thickness and paper-fasteners (Size 00) or better of three-ply wood and bifurcated nickel rivets (Size No. $14\frac{8}{16}$).

First draw the body, A, Fig. 402, $2\frac{1}{2}$ inches long. (The measurements given are important, for unless the limbs are in proportion the figure will not work properly.) Make two holes with the drill, if wood is being used, as in Fig. 402.

The arms, B, are $2\frac{1}{4}$ inches long, the hands must be large enough to contain holes to carry a wooden knitting needle ($\frac{1}{8}$ inch in diameter). The upper part of leg, C, is $1\frac{1}{2}$ inches in length; the lower part, D, $1\frac{1}{2}$ inches. Make holes in these parts as in the figure. Take care that the holes are large enough to hold the rivet or paper-fasteners loosely, so that the limbs swing about easily.

Now fasten all these parts together. (For directions how to hammer the rivets see the previous chapter.)

Paint the figure in water colours if it is made of cardboard, if it is made of wood it may be left unpainted, or painted in oil colours.

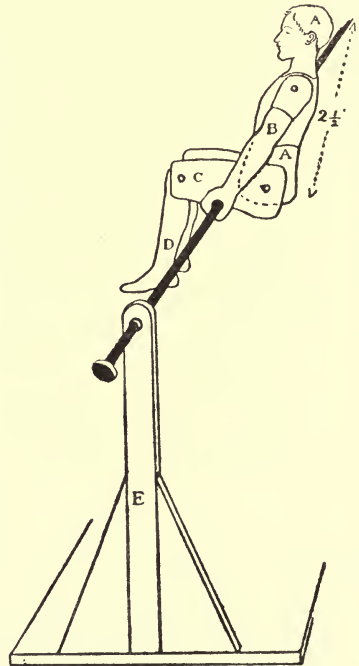

FIG. 402

Fig. 4.07

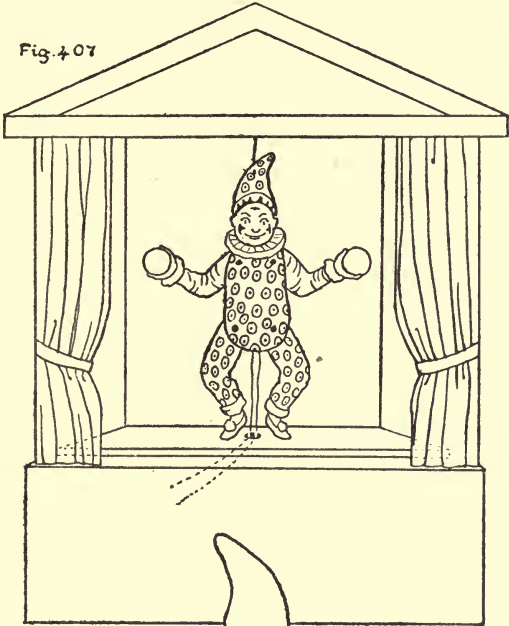

Fig. 4.04



Fig. 4.05



Fig. 4.06



Fig. 4.03

214 TOY-MAKING IN SCHOOL AND HOME

Push a wooden knitting needle (about $\frac{1}{8}$ inch in diameter) through the holes in the hands, see that it fits tightly, add a little glue if there is any danger of the needle slipping round inside the holes.

Two pieces of stripwood, E, are next sawn about $11'' \times \frac{1}{4}'' \times \frac{1}{2}''$. These posts must have holes drilled in them near the top for the knitting needle to pass through, and revolve freely. The posts are nailed and glued to a base, the size of which will depend upon the length of the bar which the gymnast turns upon.

Two or three gymnasts look well swinging together, or a gymnast, a monkey and a clown. In this case $12'' \times 6'' \times \frac{1}{4}''$ makes a good stand. The posts are supported by triangular supports. On turning the knitting needle the little figure will revolve in a life-like manner, and perform many of the professional exercises of the horizontal bar. The actions are made more realistic if the man's head is weighted with a piece of lead, so as to make his head more nearly the same weight as his body.

The Dancing Clown. Draw on cardboard or three-ply wood and cut out the head and body of the clown as in Fig. 403. Colour it, and cut out another piece exactly the same to represent the back of the clown. Draw and cut out two arms as in Fig. 404, two legs as in Fig. 405. Cut out two small discs of lead, and glue them behind the balls in his hands; glue little pieces of lead behind his boots. His arms and legs are fastened together by thread, as in Fig. 406. The back part of the body hides the strings.

This clown can be hung inside a box, and the strings passed through a hole (directly underneath the clown) in another box upon which he can then be made to dance, as in Fig. 407. The figure works best if properly balanced; see that the arms and legs are equal in size and weight.

Rocking Horses and Elephants. The simplest way of making a rocking horse is shown in Fig. 408. Two rockers, A B C, are cut out of cardboard (medium thickness). Next two horses, D, are drawn on cartridge paper, the distance between the fore and hind feet corresponding to the distance A C in the rockers. The horses are coloured and cut out, and their heads and tails gummed together. The four legs are then fastened with paper-fasteners (or with gum) to the ends of the two rockers. A wooden rocking horse is made in the following way. The two rockers, A B and C D,

are cut out of three-ply wood with a fret-saw. The arc of a circle of 4 inches to $4\frac{1}{2}$ inches radius is a good size ; width of rocker, H K (Fig. 409), $\frac{3}{4}$ inch.

Three pieces of stripwood $\frac{1}{4}$ inch by $\frac{1}{4}$ inch are sawn, length $3\frac{1}{4}$ inches, E, F and G. Pencil-marks must be made on the two rockers to show where these strips are to go, one in the middle,

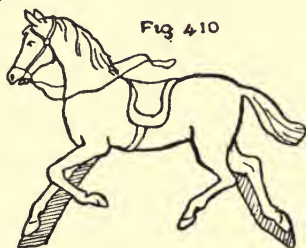
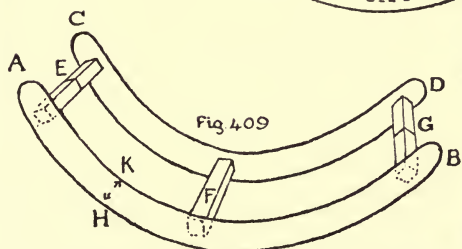
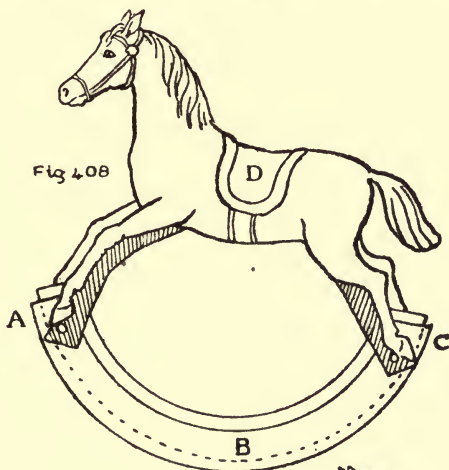

the other two at the ends. Before fastening them on, a slit is sawn in the middle of each end-piece, as at E and G.

Strips E, F and G are glued and nailed to one rocker, then this rocker can be laid on its side, and the second rocker glued to the upstanding strips. There is no need to nail the second rocker ; indeed, if the ends of the strips are very evenly cut, there is no need for nailing at all. The horse (Fig. 410) can be cut out of cardboard and have one front leg and one back leg fitted into the slits. Cardboard of medium thickness will just fit a saw-cut and no gluing is needed. If the horse is cut out of fret-wood or three-

ply wood ($\frac{1}{8}$ inch thick) the saw-cuts must be enlarged with a file and the feet glued in.

Instead of horses, donkeys, tigers, lions, etc., can be fixed on rockers as just described.

The rockers in Fig. 409 can also be built up of cardboard.

A Rocking Elephant. On a piece of cardboard draw a circle $1\frac{1}{4}$ inches in radius; on this draw an elephant as in Fig. 411. Colour the ball red and the elephant grey (both sides must be coloured) and cut out. Cut out a piece of cartridge paper (Fig. 412), length equal to half the circumference of the circle in Fig. 411, width, $1\frac{1}{2}$ inches. Fold in half along D E, cut out D B C E, as in diagram, the shaded portions being cut away. Gum B D C E to disc H as in Fig. 411, so that D F E G forms a rocker; make a similar rocker for the other side. Two pieces of lead (A in Fig. 411) are cut out and glued on each side of the disc at the bottom, as in the figure. The lead must have papersuitably coloured pasted over it. The elephant will swing up and down at the slightest touch. Instead of an elephant a clown can be drawn on the ball.

Fig. 413 shows an elephant rolling on his back. This toy can be made in the same way as the first elephant. A circle ($1\frac{1}{4}$ inches radius) is drawn first, and the elephant drawn in the circle. These elephants can be cut with the fret-saw from satin walnut ($\frac{1}{4}$ inch thick). In this case the lead on each side must almost reach the diameter, as shown in Fig. 413. Another disc of wood ($1\frac{1}{4}$ inch radius) must be fret-sawed out of the satin walnut, sawn in two, and the halves glued one on each side of the lead, to make a base wide enough for the toy to rock upon without upsetting. No lead will then show, and it will look like a wooden toy. If these toys are cut out of thin wood, $\frac{1}{8}$ inch thick, they still require at least twice as much lead as the cardboard toy.

The elephant may also be drawn balancing a ball instead of a clown.

Children will delight in making these toys from cardboard, paper and lead for a toy circus.

Fig. 414 shows a swan drawn in a circle; the shaded part represents the paper rocker on one side. This model requires no lead. A duck can be made in the same way.

Fig. 415 shows a design for elephants on a see-saw. The elephants must be the same size as far as possible.

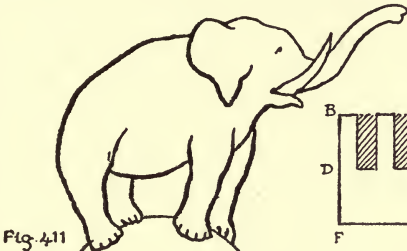

Fig. 411

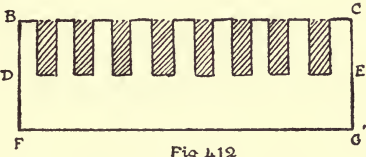

Fig. 412

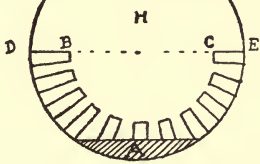

Fig. 413



Fig. 414

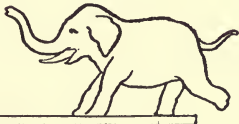
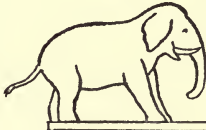
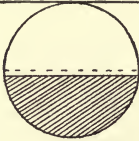

Fig. 415



CHAPTER XVII

MOVING FIGURES

FIG. 416, "The Washing Day," shows a pattern that will please little English toy-makers. It can be cut from wood with the fret-saw, or with scissors from cardboard of medium thickness.

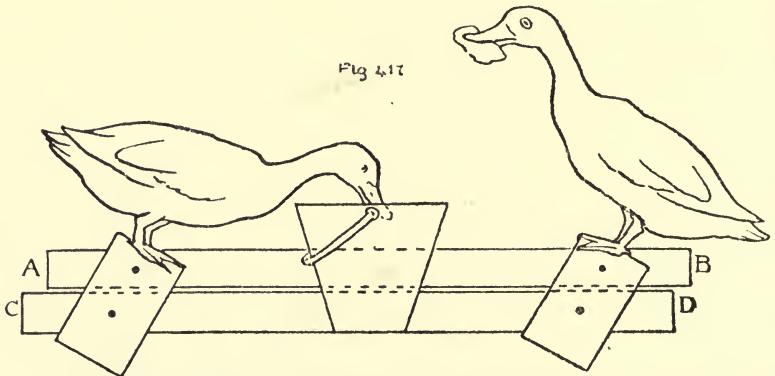
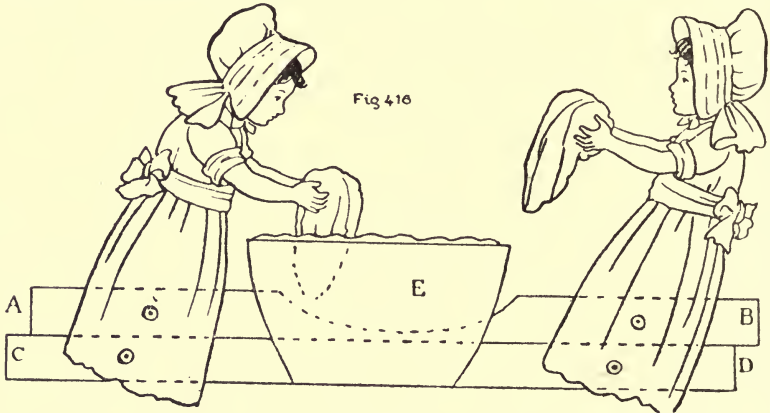

To make the Design. First cut two lengths of three-ply wood or cardboard, $\frac{1}{2}$ inch by 8 inches, A B and C D.

Next draw on wood or cardboard, and cut out, the two little washer-women (they are about $4\frac{1}{2}$ inches high). They look more effective if painted.

These are fastened to the strips of cardboard by means of paper-fasteners (Size 000; one gross sixpence); the holes for the fasteners are about $1\frac{1}{4}$ inches from the ends. The holes in the little washer-women are exactly one above the other, so that when the paper-fasteners are in and A B is exactly above C D, the figures are upright.

A washing tub, E, is cut out of cartridge paper (top of tub, 3 inches, bottom $1\frac{3}{4}$ inches); this can be painted brown or green and have a white rim round the top to represent soap-suds. This tub is gummed to C D, exactly between the two little washers. If the part of A B that comes behind the tub is cut away as in diagram the figures will work better.

When the strips of cardboard are moved backward and forward the figures put their clothes in the tub and take them out again. The toy works best if a little space is left between A B and C D, as in Fig. 417. If it is cut out of fret-wood the figures are fastened by rivets, as explained in Chapter XV.

Fig. 417 shows two ducks eating out of the same bucket; strips of cardboard, A B and C D, are the same size as those in Fig. 416. The bucket is cut out of cardboard and gummed to C D.

The sailors in Fig. 418 are made in the same way, holes are made in their hands, through which yarn is passed (the thicker the yarn the more like rope it is) or oars can be cut out of cardboard and fitted in the holes in their hands, when they will appear to row.

Fig. 419 shows a man driving a donkey. It is made of cardboard, except the whip, A, which is thread tied into a hole in the cardboard at c. The whip will work better if a little piece of lead or something heavy is tied at the end of the thread. The reins, B, are of thread or yarn, and pass through holes in the donkey's mouth and in the man's hand.

Two fishermen can be made in the same way, the whip easily becomes a fishing-rod and a lead fish can be attached to the end of the line.

In the case of the donkey-driver and the fishermen the strips

220 TOY-MAKING IN SCHOOL AND HOME

of cardboard should be longer than shown in the figure, to leave room for holding. The strip for the donkey-driver should be

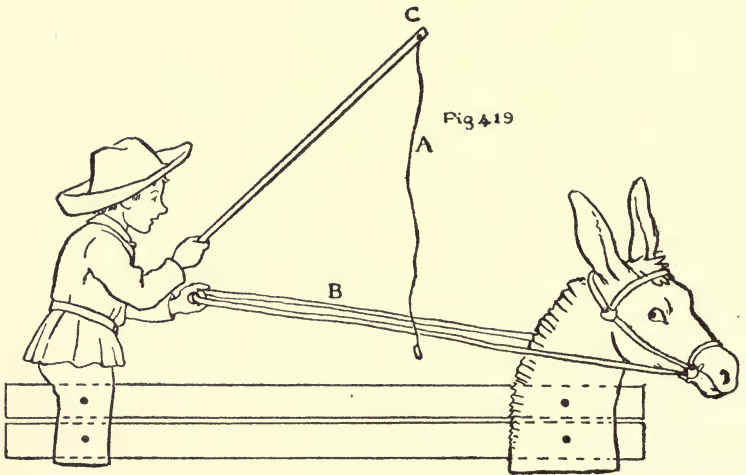
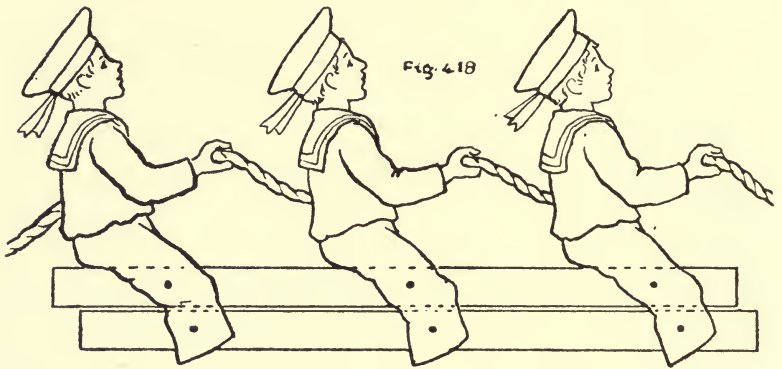

about 9 inches, the fishermen require at least 12 inches if their lines are not to get entangled.

Children will readily think of other designs for this simple but interesting toy.

CHAPTER XVIII

SOME OLD-FASHIONED TOYS—A MONKEY-UP-A-STICK, A JACK-IN-THE-BOX

A Monkey-up-a-stick is a very easy toy to make. First cut out a cardboard or wooden monkey as in Fig. 420. See that the legs and arms turn freely on paper-fasteners, A and B. Paint the monkey grey or brown. With a pin make holes, C and D, in the feet and hands. Next saw two lengths of stripwood, one $1' \times \frac{1}{4}" \times \frac{1}{4}"$, the other almost twice as long. Drill a hole near one end of each of these sticks. Pass a pin or piece of wire through the holes in the monkey's feet and the hole in the shorter stick; bend down the pin on each side to keep the feet from slipping off. (The point of the pin should be cut off with pliers.) In the same way fasten the monkey's hands to the longer stick. See that the limbs (note that they come one on each side of the stick) revolve freely on the pins or wire. The two sticks may be kept together by pieces of elastic; this however rather prevents the one stick from moving freely up and down the other. It is better first to file the sticks (or one of the sticks) round or to use dowel rods. These round rods can then be kept together by cardboard or wooden discs. The disc must have a hole in the middle large enough for the rod to move freely up and down in it. The thicker the piece of wood or cardboard the better. The hole must be made in the wood with a brace and bit (a bradawl will make the hole in cardboard, and it can be filed to the right size with a round file). The longer rod, A, Fig. 421, goes through the hole; the bottom of the shorter rod, B, is glued and nailed to the disc.

By moving the disc C up and down the monkey performs its usual antics at the top of the stick.

The monkey, or a clown if preferred, looks very effective cut out of three-ply wood and riveted together.

For a small model wooden meat skewers may be used as sticks.

Other suggestions for c in Fig. 421 are: a reel (though rod B when glued to a reel tends to break off); half a cork.

More interesting than the "monkey-up-a-stick" is the monkey that climbs a rope, though this little animal has sometimes an irritating manner of swinging about on the rope, and

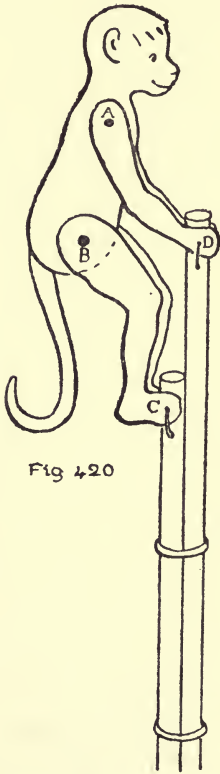

Fig. 420

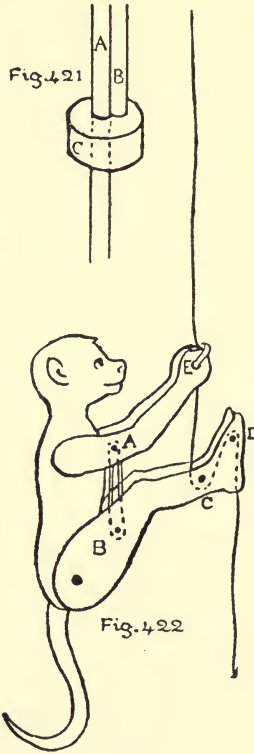

Fig. 421

Fig. 422

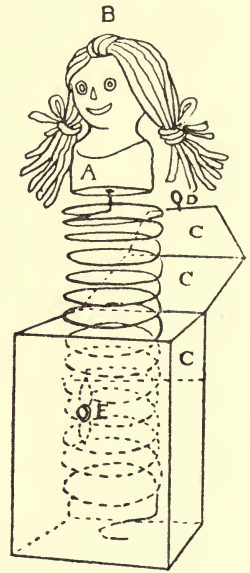

Fig. 423

going no higher. If he is carefully made according to the following directions he ought to climb. The monkey is cut out of cardboard in the same way as the first monkey, except that his two arms are gummed firmly on in the position shown in Fig. 422, his legs only being free to move. Pins or pieces of wire are passed through the holes at A, B, C, D. In the case of pins, the point is cut off with cutting pliers and the rest doubled back to prevent its coming out on one side, the head of the pin prevents it coming

out on the other. Tie a piece of thin elastic round the pins, A and B, so that it is only just on the stretch when the legs are drawn up parallel with the arms, as in the figure. A piece of wire is passed through at E and is bent over outwards, drawing the hands fairly tightly together. A piece of thread is passed through the eye so formed, down and under the pin, C, then over the pin, D. By alternately slackening and tightening the line the monkey will climb up the thread in a very life-like manner.

Care must be taken to nip the wire well together at the hands to get enough friction to hold the thread firmly while the elastic pulls the legs up, on the other hand the thread must be just loose enough to pass through E.

A Jack-in-the-box. The simplest way of making a Jack-in-the-box is the following. Get some ordinary wire (quite thin wire will do) about 4 feet long or longer if a bigger jump is required. Wind this tightly round a broom handle, keeping the rings of wire close together. Slip it off. Take a cork, cut it so that it is about $1\frac{1}{4}$ inches high. File it round in the shape of a head as in Fig. 423. Mark the eyes and nose in ink, the mouth with red paint; or two beads can be glued in for the eyes. To make the hair, cut several short pieces of black wool, tie them in the middle at B, and glue or pin them to the middle of the head; tie back the side ends with yellow or red wool as in the figure. Fasten one end of the wire spring in the centre of bottom of cork, as at A. A piece of muslin is then gummed round the cork to hide the spring, so that it is loose and folds easily.

Next make a box, $2\frac{3}{4}$ inches high, or take the cardboard box that contains a bottle of Le Page's liquid glue, and cut off about one-third. Cut off the cover and glue it on to one side (C in the figure). Make loop of wire at D, and insert a paper-fastener at E to catch the wire loop. Fasten the end of the spring to the bottom of the box, by passing it through the hole in one bottom flap, bending it over and gluing over it the other flaps that form the bottom. Coloured paper or scraps may be gummed to the sides and top of the box. This is a suitable toy to be hung on a small Christmas tree.

A larger and stronger Jack-in-the-box can be made from a wooden box about $5\frac{1}{2}$ inches square. For this a piece of No. 12 gauge wire about 10 feet long is required; it is wound around a

rolling-pin. This spring is then nailed by means of staples to a piece of wood made to fit the inside of the box. Fasten a round piece of cardboard to the top of the spring, and either sew on to it a small doll's head, or make a doll's head of part of a stocking stuffed with wool and having eyes, mouth, etc., sewn on. A cap (a fool's cap looks best) is made to fit the head, and a loose jacket is sewn on to hide the spiral body.

CHAPTER XIX

LITTLE SWORDSMEN

FIG. 424 shows the principle on which this toy is made; the shaded portion represents the inside of a box. A good size for a box to make this toy is $9'' \times 4\frac{1}{2}'' \times 2\frac{1}{4}''$. Slits should be cut in the long side of the box at *a b, c d, e f, g h*. These slits may be made with a pen-knife, and a fret-saw file will make them wide enough for a piece of cardboard to slip up and down in.

Slits are then made in the short side exactly under the long slits, as *p n* in Fig. 425. Widen these slits also with a file.

Next cut out the cardboard figures. Draw head, body and one leg to be cut out in one piece; about 3 inches of cardboard should be left below the foot (*M* and *N* in Fig. 424), the total length of figure being about 8 inches. Cut out another figure like this. Make holes just below the foot as at *D* in Fig. 424.

Next draw and cut out legs, *F* and *H*. Notice that they do not project so far inside the box, their length being about $3\frac{1}{2}$ inches. Fasten these to the figures by paper-fasteners. Next cut out a long strip of cardboard, *A B*, $\frac{1}{2}$ inch by 14 inches. Pass this through the slits (*p n* in Fig. 425) in the short sides of the box. See that it slides easily up and down in these slits.

The portions marked *M* and *N* turn on pivots *h k* and *m l*. These pivots pass through holes, *D* and *E*, in the figures and through holes made at each side of the box exactly opposite the short slits. Steel knitting needles make good pivots, or pieces of cane. When the top is quite complete these pivots may be glued into the holes in the box for greater security. Fasten pieces of lead at the bottom of *M* and *N* so that the figures swing easily on the pivots.

When it is found that the pivots are in the right place, pass the strip of cardboard *A B* through the slits, and fasten the legs,

226 TOY-MAKING IN SCHOOL AND HOME

F and H, to it by paper-fasteners, as at x and y. See that the needles are in the right holes and fasten up the box.

(It is a convenience in making this toy to let the cover form one side, the cover being left off until all the inside arrangements

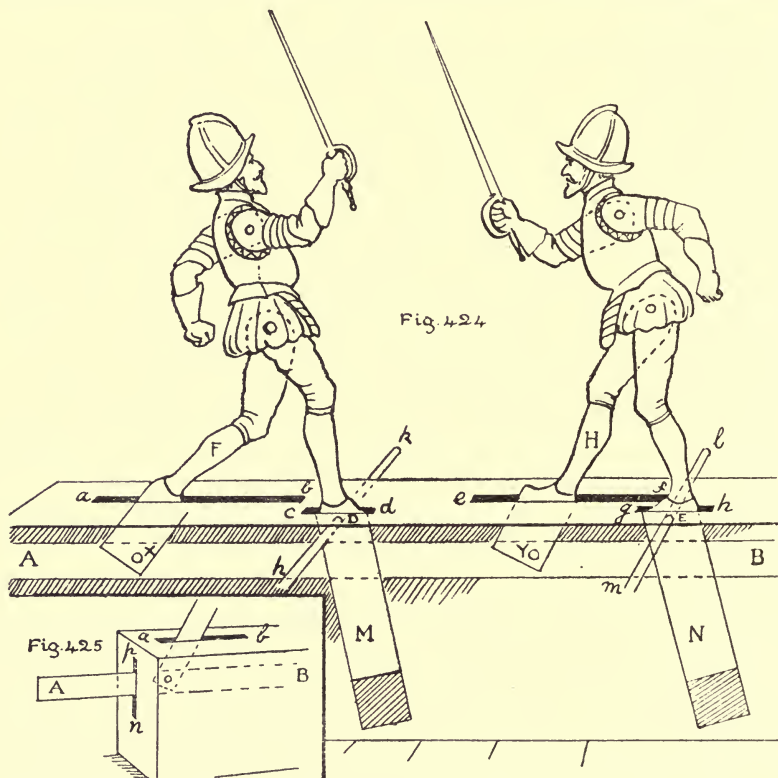

are complete ; the pivots can then be put into their holes in the cover, and the cover put on.)

Now if the projecting ends of A B are pushed backward and forward the figures fight in a very realistic manner. Notice that A B has two movements : one backward and forward, the other up and down. The lead weights in M and N keep A B up. Generally speaking, the longer the slits are the better the figure works. This, however, does not apply to slits c d and g h. The slits need not be so close together as in the figure if it is desired that the swordsmen should fight at a greater distance.

The arms are cut out of cardboard and fastened by paper-fasteners on each side of the figure ; the swords may be cut out with the arms, or made separately and gummed on afterwards, pieces of cane making effective swords. A more difficult but more satisfactory way of putting on the arms is this : pass a very short piece of cane through the hole in the body, where the arms are to be fastened ; see that it turns very easily in the hole ; next scotch the pieces of cane that project at each side into holes in the arms ; see that one arm is up, the other down. To make the arms balance well, it may be necessary to fasten a small piece of lead to one hand.

This toy is most amusing if carefully made. The following hints may be useful :

(1) Draw and paint the little swordsmen as carefully as possible.

(2) See that the slits are perfectly straight and wide enough for the cardboard to pass through.

(3) See that the arms, legs and feet turn easily on their pivots, whether these pivots be paper-fasteners, cane or knitting needles.

(4) See that sufficient lead is attached.

(5) Cover the box neatly with paper, but *not* the slits. A piece of green paper looks well for the top.

This toy may also be cut out of wood with a fret-saw. Many other amusing toys can be made on the same principle.

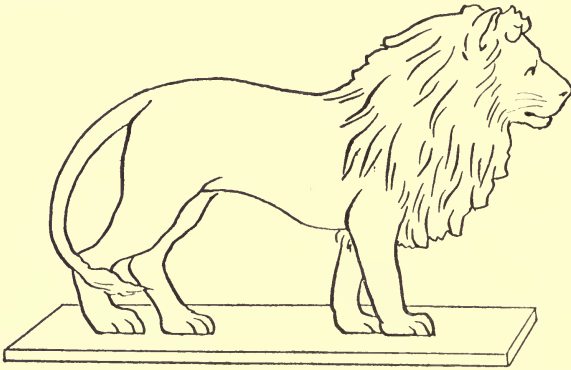

Fig. 426

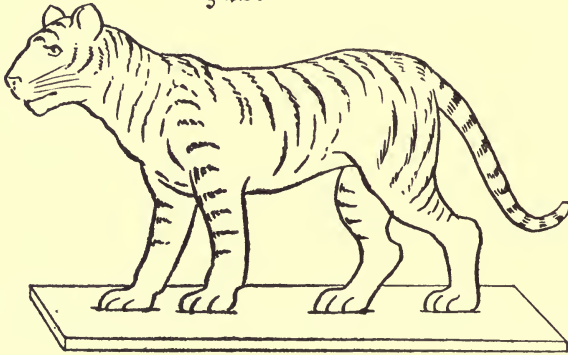

Fig. 427

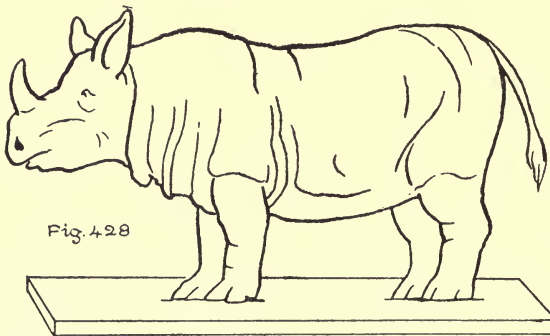

Fig. 428

CHAPTER XX

SOME MORE FRET-SAW TOYS

BESIDES the numerous models already described that can be made with the fret-saw, endless further toys might be made, among others the following.

1. **A Zoo or Wild-Beast Show.** The animals for this may be jointed models like the elephant and giraffe (Part I, Chapter XX); in this case they will stand quite well; or they may be cut in one piece and glued to an oblong strip of wood for a stand, as the lion

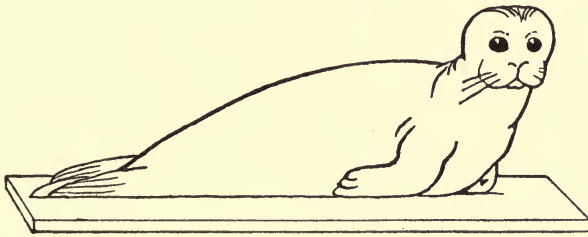

FIG. 429

and other beasts in Figs. 426 to 430. Three-ply wood or satin walnut $\frac{1}{8}$ inch thick is suitable for these animals, which however may also be cut out of cardboard and glued into slits cut in a wooden stand.

2. **Forest, Jungle or Desert Scenes, etc.** (Figs. 431 to 437). These trees, which have very characteristic shapes, can easily be cut out with the fret-saw. Where the branches are slender and there is danger of their breaking, use three-ply wood. They should be painted green, with the markings indicated in the drawings put in with sepia or dark green.

3. **A Farmyard, with trees, ducks, cows, etc.** Figs. 438 to 443 are patterns of farmyard animals. There is considerable educational value in the drawing and cutting out of the simple

230 TOY-MAKING IN SCHOOL AND HOME

outlines necessary in fret-wood trees or animals. It will help children to think in lines, as it were, and to draw boldly.

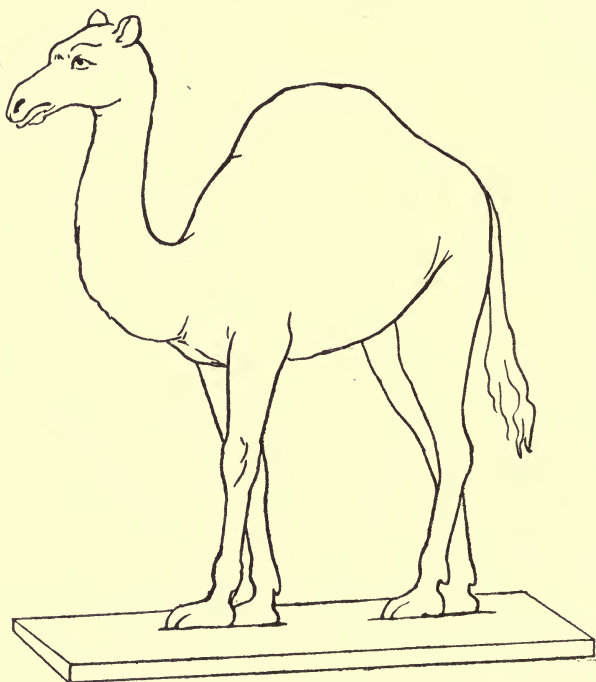

FIG. 430

Teachers will find sets of fret-wood animals and trees of use in the Nature Study and Geography lessons.

4. **Soldiers, Sailors, Boy Scouts, etc.** Figs. 444 to 447 may be cut out and glued on stands in the same way.

The small files used for fret-wood are useful to finish and 'clean up' these toys.



Fig.431 The Walnut



Fig432 The Palm (Cocoa-nut)

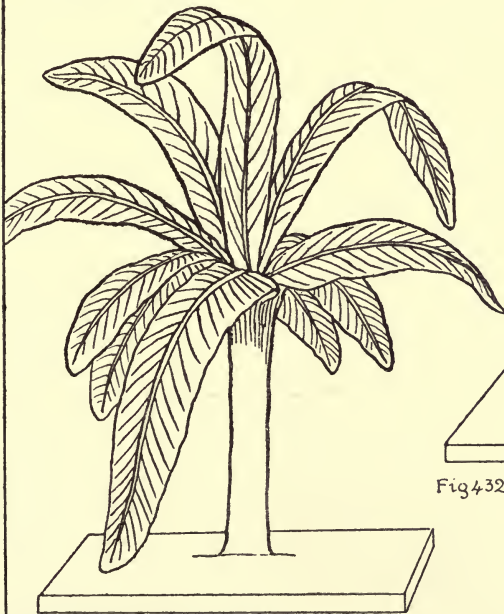

Fig433 The Palm Oil Tree

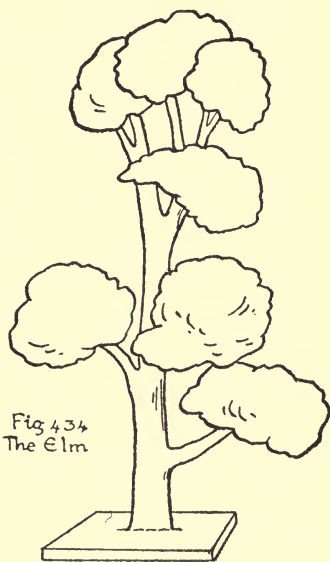

Fig 434
The Elm

Fig. 435
The Spruce Fir

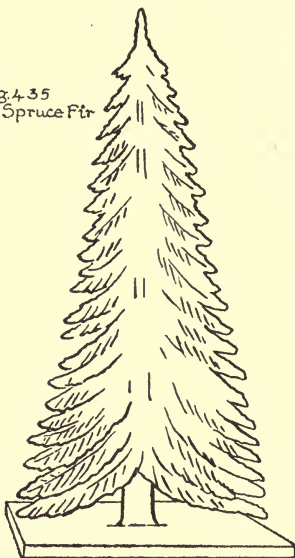

Fig. 436
The Lombardy
Poplar

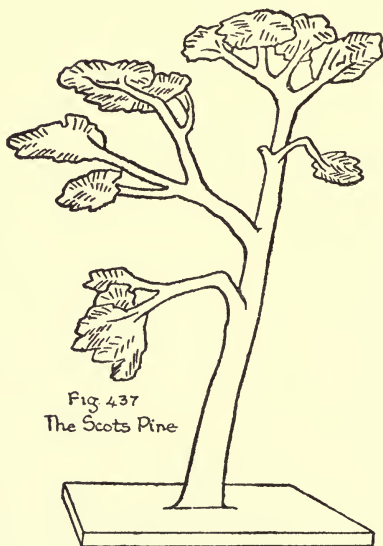

Fig 437
The Scots Pine

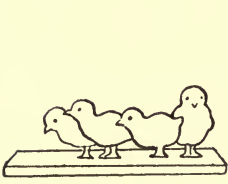

Fig. 438



Fig. 439

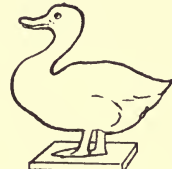

Fig. 440

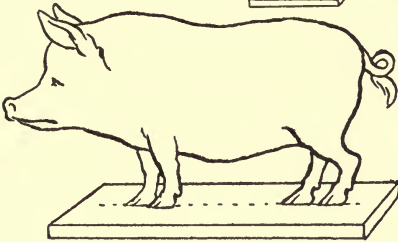

Fig. 441

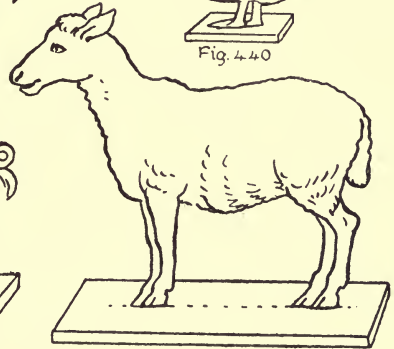

Fig. 442

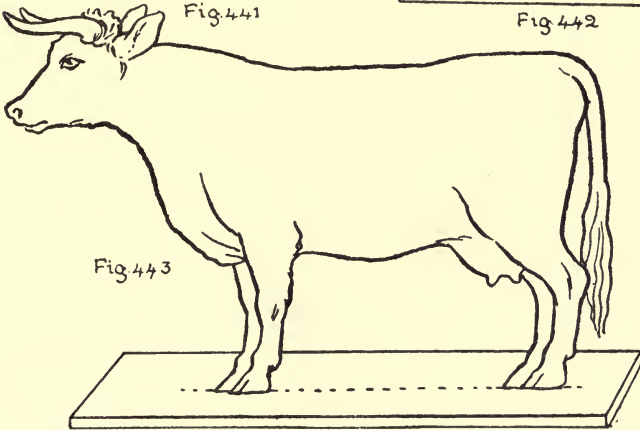

Fig. 443



Fig. 444



Fig. 445



Fig. 446

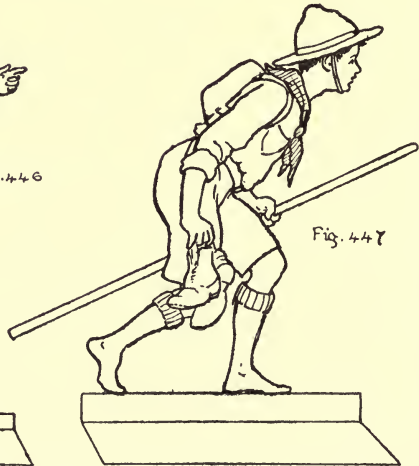

Fig. 447

CHAPTER XXI

TOYS WORKED BY SAND

For these toys a wooden box is required, *A B C D* (Fig. 448), about a foot or more square and 5 inches deep. *L* is a wheel made like the over-shot water-wheel in Chapter VI. Another way of making the buckets is shown in Figs. 449, 450, and 451. These are glued close together between two circles of cardboard as shown in

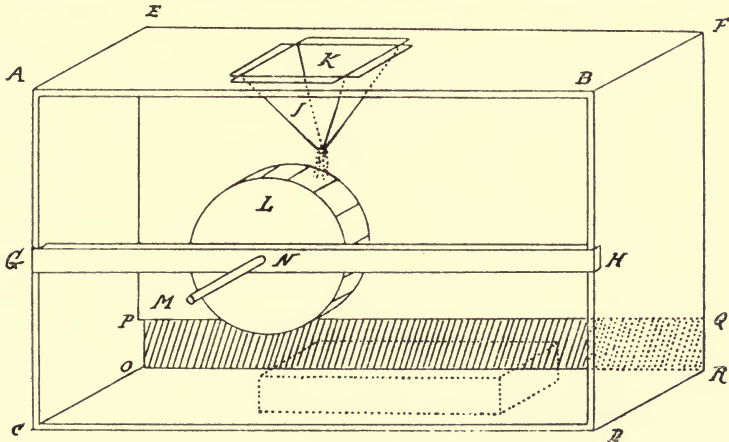
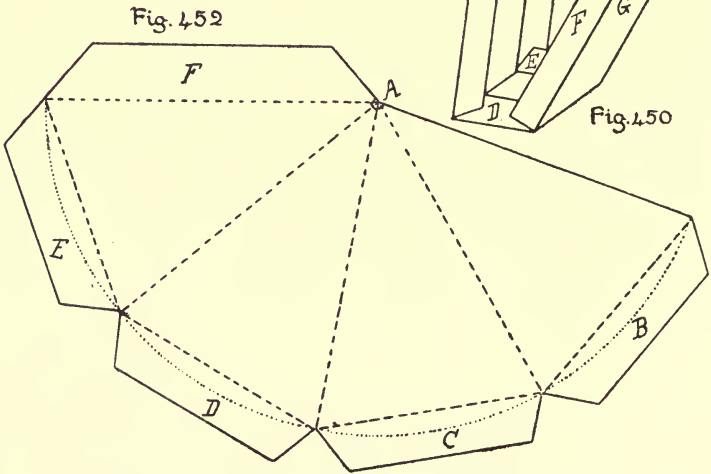
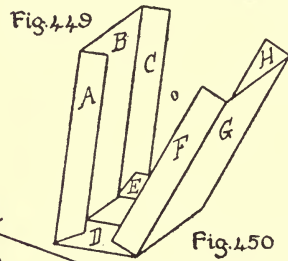
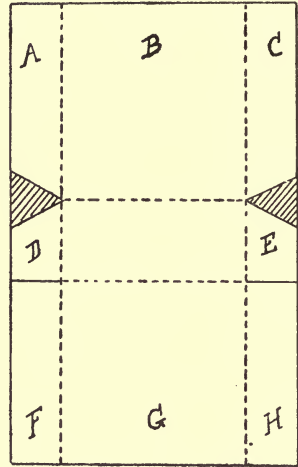
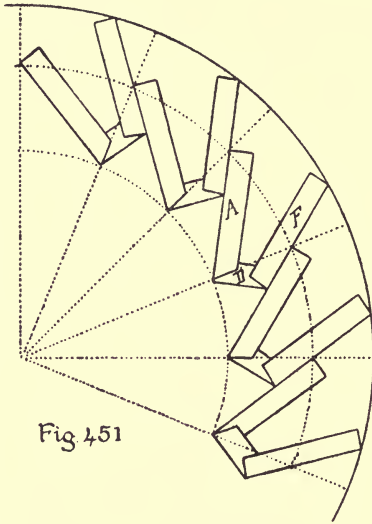

FIG. 448

Fig. 451. This method is somewhat easier if small wheels are required. The wheel should have ten or more buckets; the greater the number of buckets, the faster the wheel works.

Fig. 452 shows the construction of the reservoir, *J*, through which the sand runs. The size of it will depend upon the toy made.

F is the flange for fastening it together, and *E, D, C, B* are flanges for fastening it to roof *A B E F* (Fig. 448). A round hole is filed out at *A*, after the reservoir is fastened together, through



which the sand runs. The wooden side of box, $A B E F$, is taken off and a piece of cardboard is nailed to the box instead. This can have a hole cut in it, κ in Fig. 448, and the reservoir glued under it. $G H$ is a bar of stripwood nailed across the front of the box, through which a hole, N , is bored. The axle of the wheel passes through this and through a corresponding hole in the back of the box. As the sand runs out of the reservoir, it falls into the boxes and so turns the wheel; hence the sails of a windmill, the hands of a clock, etc., fastened to axle, $L M$, can be made to turn. Notice carefully that the hole at the bottom of the reservoir should be over the centre of the boxes of the sand-wheel and a little to one side of the wheel, as in Fig. 448. Part of the back of the box, $P Q R O$, should be cut out to allow a tray to go in to receive the sand.

To make a Bicyclist (Fig. 453). Cut two circles of cardboard, radius $1\frac{1}{4}$ inches. Mark on them the spokes of a bicycle.

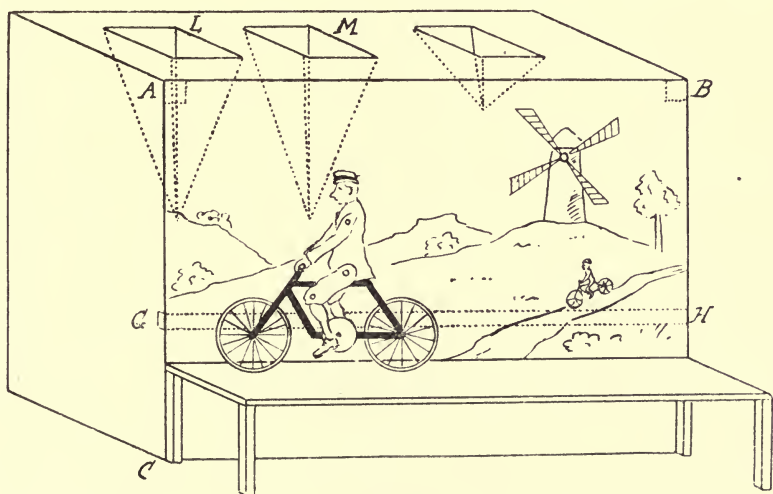

FIG. 453

Make two sand-wheels the same size as the bicycle wheels; their width should be about $\frac{1}{2}$ inch to $\frac{3}{4}$ inch. Take a piece of stripwood $\frac{1}{2}$ inch by $\frac{1}{4}$ inch and the length of the box. Make holes in it, 3 inches, $4\frac{1}{2}$ inches and 6 inches from one end. Nail the bar across the box 3 inches from ground; make holes in the back of

the box exactly opposite the holes in the bar. Make wooden axles to pass right through these holes so that they turn freely in them. The sand-wheels should be glued to two of these axles. Now cut out a piece of cardboard to fit over the front of the box; bore holes in it corresponding to those in the bar, *Г Н*. Paint on it a suitable background, as in Fig. 453. Nail small pieces of strip-wood, $\frac{1}{2}$ inch by $\frac{1}{4}$ inch, to the corners of the box (as at *A* and *B* in Fig. 453), to which the cardboard can be fastened by drawing-pins or glue. Pass the axles of the sand-wheels through the first and third holes from the end of bar *Г Н*, and let them project about 1 inch beyond the cardboard. To these ends the bicycle wheels must be glued. In making this toy it is better not to fasten pieces together too quickly, until all the various parts are ready.

The figure of the cyclist should be cut out to the measurements given for the little gymnast in Chapter XVI. The body and head could be cut out of thin three-ply wood, and the arms

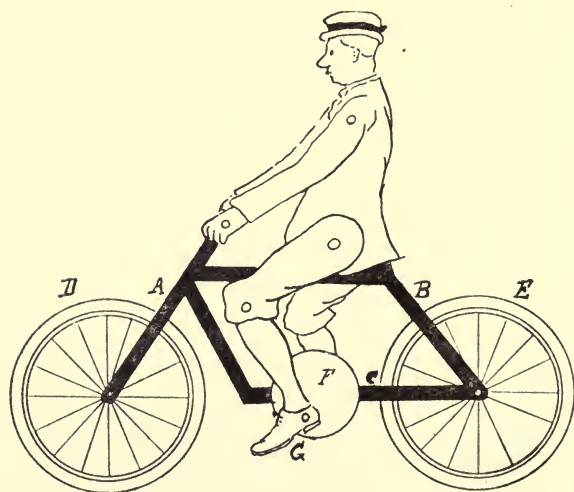

FIG. 454

and legs of cardboard. The best method of joining limbs to the body so that there is the least possible friction is as follows. Cut off a small piece of a pin, including the head, pass it through the holes, and apply to the cut end a tiny drop of sealing wax. Make holes in the cyclist's feet at *G* (Fig. 454). Cut a small cardboard wheel, *F*, about $\frac{1}{2}$ inch in diameter: make a hole in its centre and one near the circumference.

Glue a piece of match stick into the hole near the circumference, the other end of this match stick must turn freely in the hole in

the cyclist's feet at *G* (Fig. 454). Cut a small cardboard wheel, *F*, about $\frac{1}{2}$ inch in diameter: make a hole in its centre and one near the circumference.

cyclist's left foot. Pass the axle already made through this wheel, to which it must be glued, and through the cyclist's right foot and through middle hole in the bar.

Make two small pulley wheels (*e.g.* slices of reels with cardboard flanges), one twice the size of the other. Fig. 455 shows how the toy is put together and how it works. A and B are the sand-wheels; axles, F G and F M, are glued into them and into the two bicycle wheels. K H is the axle passing through centre of pedal wheel. N O are pulley wheels glued to axles, F G and H K,

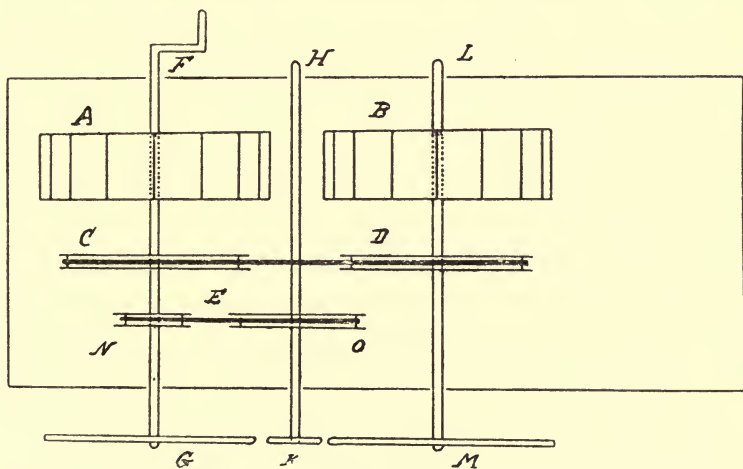

FIG. 455

respectively, and connected by an elastic band, E. When sand-wheel, A, turns round, wheel, N, turns and turns pedal wheel, F, in Fig. 456, and as O is twice as big as wheel N, the pedal will revolve twice as slowly as the bicycle wheels.

Pulleys of equal size, C and D, might be added with advantage to connect the two sand-wheels, and a handle at F to start the wheels.

Fig. 456 shows how the leg is fastened to the pedal wheel. To keep the cyclist's body steady cut a piece of stripwood $1" \times \frac{1}{4}" \times \frac{1}{4}"$. Glue one end to middle of cyclist's body and the other to the cardboard background.

B (Fig. 454) is a thin piece of wood, passing over the projecting end of axle of wheel, E, its other end being glued to the bottom

of the cyclist's body. A similar strip, *A*, is cut. This is fastened between his hands by a little piece of pin, and passes over the axle of wheel, *D*. *C* is a thin strip of wood or cardboard which passes over the axle of *E* and can be glued to the cyclist's right leg and pass behind wheel, *F*.

Make a platform as in Fig. 453 to support the cyclist. Make two reservoirs as already described. Cut a piece of cardboard to fit over the top of box and make holes in it, *L* and *M* in Fig. 453. Glue the reservoirs under these. Make a cardboard tray to fit under the wheels for the sand to fall in. Another wheel might

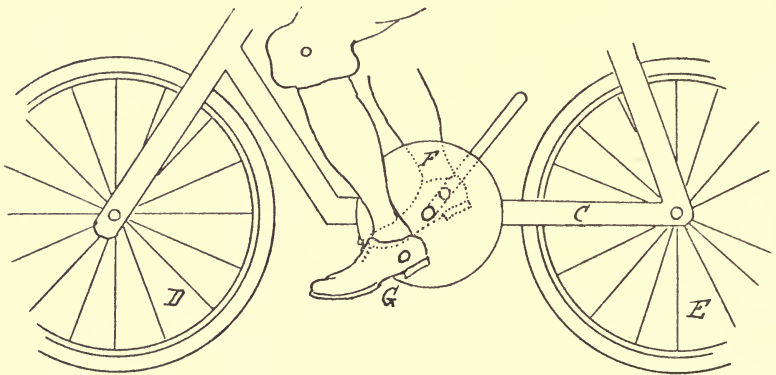

FIG. 456

be added to work the sails of the windmill in the distance. Very fine sand must be used for working these toys, the best is silver sand and it should be kept as dry as possible.

Fig. 457 shows another modification of this toy. *B* is a box turned upside down and placed in front of that containing the sand-wheel. *A* is the cardboard background, suitably coloured. The sailor's legs are cut in one piece and glued into a slit in the box. The body is fastened to them at *F* by a small paper-clip so that it moves very freely. The arm is fastened on at *G*. A small match stick passes through the hole in the hand and is glued in the hole in circumference of wheel *E*.

The axle, *M N*, to which this wheel is glued passes through the cardboard or wooden standard, *D*, through a hole in the background, *A*, and through the centre of the sand-wheel. *D* is fixed to the box. The arm of the crane, *C*, made of cardboard or three-

ply, is glued to D. A hole is made at G and a corresponding hole in A opposite G. Pass a small stick of wood or cane, κ , through these holes and glue it in. The crane should be about 1 inch from the background. κ keeps the arm of the crane steady. Tie a

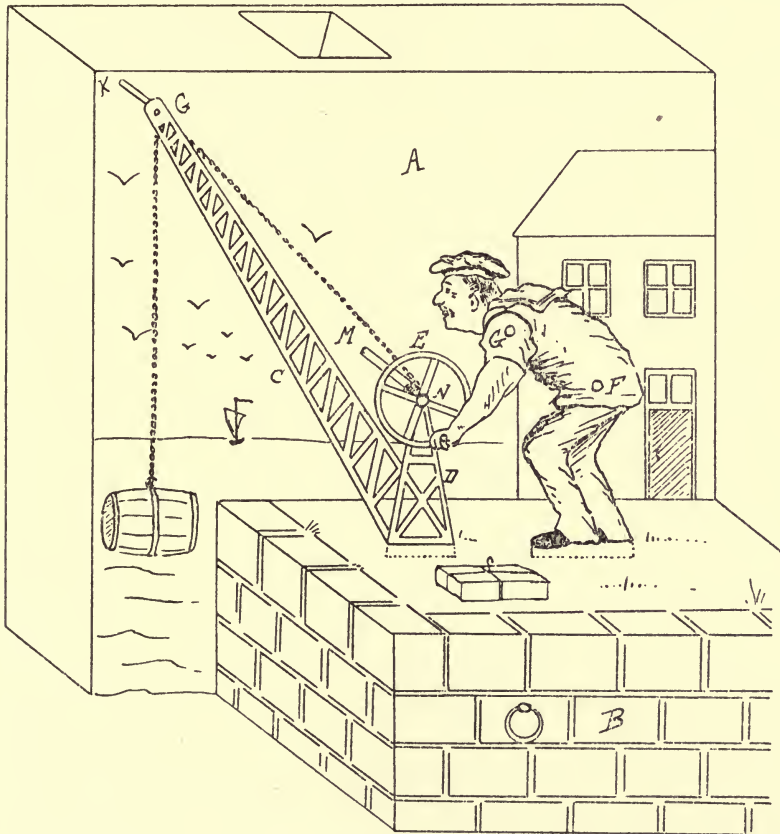

FIG. 457

piece of cotton to the axle of wheel E, pass it over κ or over a small pulley wheel revolving on κ G; tie to it a thin wire hook to which a paper box or barrel can be fastened.

In the same way a sailor can be made to work a windlass and drag a paper boat up a sloping beach, a man can draw water from a well or turn a barrel organ, or a paper mouse gummed to a cardboard base can be drawn along until it disappears into its hole.



FIG. 458

CHAPTER XXII

TOYS WORKED BY WHEELS, ETC.

FIG. 458 shows how a clown can be mounted on a cart so that when the cart is drawn along he dances and waves his arms. In toys of this kind, the wheels should be quite half-an-inch in thickness. They are glued on to round axles which turn freely in small screw-eyes or in holes in wooden blocks fastened under the car or cart. If any part of the axle projects beyond the wheel it gets in the way of the wires. The clown is made of cardboard or three-ply, according to design given in Chapter XVI. It is then fastened securely to rod B, and the latter glued into a hole in the middle of the cart. Fairly strong wire is fastened to the wheel by a nail with a broad head so that when the wire is looped round the nail it turns freely on the nail but does not come off. The wire is bent at right angles twice to bring it close to the figure, as shown at A. It must fit accurately into the holes in the figure. Notice that one leg passes on each side of the post.

The clown works best when cut out of wood. In this case the body E and post B may be cut out in one piece, one leg and one arm are then attached to the front of the body, and one leg and one arm behind.

Fig. 459 shows a soldier on the march. He is made of three pieces of wood. Head, body, arms and stand A are cut out in one piece, the legs are cut out separately and riveted loosely to the body; only two pieces of wire are needed, one on each side, to work the legs. The gun may be a piece of wire or wood fixed on afterward. The wheels are $\frac{1}{2}$ inch in thickness.

Other similar toys worked by wheels can be made by cutting a hole in the bottom of the cart. One axle of the cart must run exactly under this hole, it must be made of wire and bent as B C in Fig. 460.

D and E are pieces of tin nailed to the cart, through holes in



FIG. 459

which axle *BC* freely turns ; or wooden blocks may be nailed on for the axle to turn in, if tin cannot be obtained. The ends of the axle are securely fastened into solid wooden wheels. As the wheels revolve they will push up and down a piece of wire or wooden rod, *F*, which is fastened to the bent part of the axle.

Now *F* can be used to work a number of simple toys, if its free end is fastened to the part which it is desired to move. For example by this means an animal's mouth may be made to open and shut as it is wheeled along, or its head to wag ; a blacksmith may be made to strike his anvil, the drummer to beat his drum. The ingenious child will be able to adapt this simple piece of mechanism to many a toy.

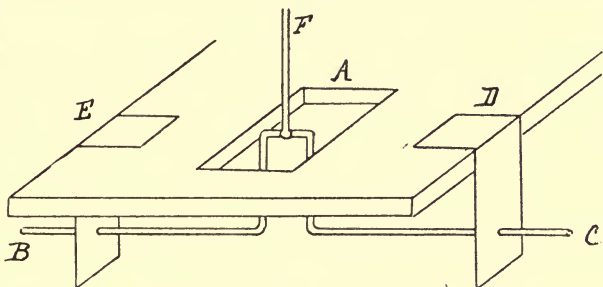

FIG. 460

For example by this means an animal's mouth may be made to open and shut as it is wheeled along, or its head to wag ; a blacksmith may be made to strike his anvil, the drummer to beat his drum. The ingenious child will be able to adapt this simple piece of mechanism to many a toy.

A Lively Dog. Cut out with a fret-saw two pieces of wood as *f* in Fig. 461, which represents the body and legs of a dog in one

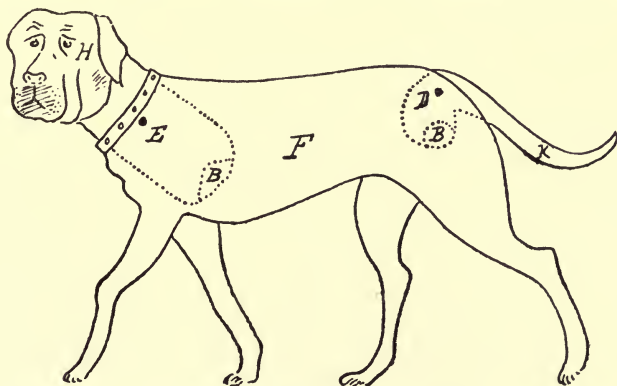

FIG. 461

piece. Now cut out the head *H* (notice length of neck behind body) and the tail *K* from wood $\frac{1}{4}$ inch thick.

246 TOY-MAKING IN SCHOOL AND HOME

Now glue the two bodies to a piece of stripwood *A* ($\frac{1}{2}$ inch by $\frac{1}{2}$ inch) placed along the tops of bodies inside (Fig. 462), and bevelled so that the legs of the dog will be further apart than the upper portion. The legs are joined by pieces of stripwood, *M*, $\frac{1}{4}$ inch by $\frac{1}{4}$ inch, about $1\frac{1}{2}$ inches long. Notice that the ends of these strips are bevelled. Now make hole, *E*, in the head-piece; notice that there is the same length of wood above *E* as below it. Make corresponding holes *E* in sides *F*. Pass a piece of wire through the hole in the

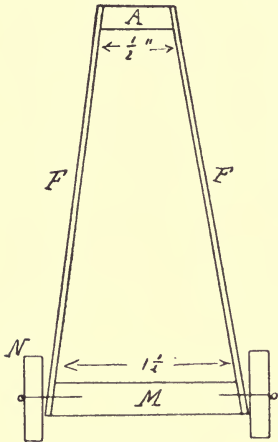

FIG. 462

dog's head and see how it hangs; the head portion will be the heavier and sink. Now take the head off, saw out a piece of wood at *B*, insert a piece of lead and try again. It is an easy matter if too much lead has been added to cut off a little. When the head is correctly balanced, as in Fig. 461, bend over the wire so that it cannot come off. The tail, *K*, is attached in the same way.

Small wheels, *N*, cut from some convenient round rod are then nailed to *M*. The dog should be suitably coloured. When drawn along he wags his tail and bends his head.

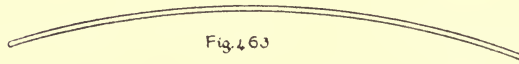

Fig. 463

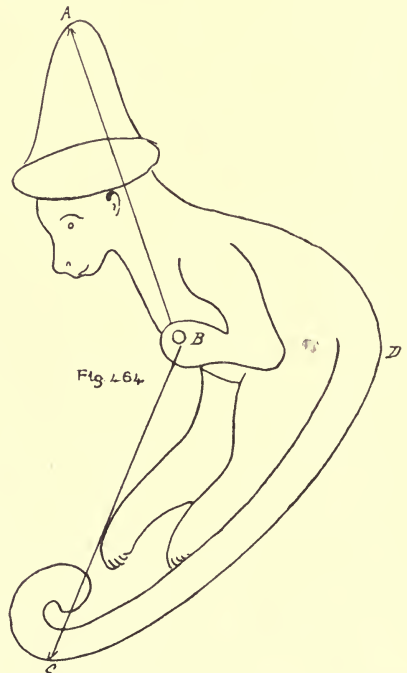

Fig. 464

The legs look rather better if cut out separately and glued to the sides.

The Tumbling Clown or Monkey. Cut out cardboard or wooden animals similar to those in Part I, Chapter XX, but use no lead. Now, instead of swinging them on a perch, make a hole at B where they stand; take a piece of copper wire, about $\frac{1}{8}$ inch thick and 6 inches long.

Bend it slightly as in Fig. 463. Pass the wire through the hole in the animal, so that the animal fits tightly on it exactly in the middle of wire.

The animals are best cut out of thick cardboard. Fig. 464 shows a suitable animal, and the following from Chapter XX—Figs. 256, 257, 259, 263 and 264—can be adapted. As no lead can be used for the purpose to which we are now going to put them, animals that balance without lead, as in Fig. 464, are the most suitable. Therefore in designing them, one must take care that the hole B is exactly at the centre of gravity, and the bend of body, D (that is widest part of body), just below B.

To make the Monkey tumble. Cut a piece of wood 12 inches by $2\frac{1}{2}$ inches, and fix parallel bars to this as in Fig. 465. File or cut notches in the ends at A, to keep the monkey from tumbling

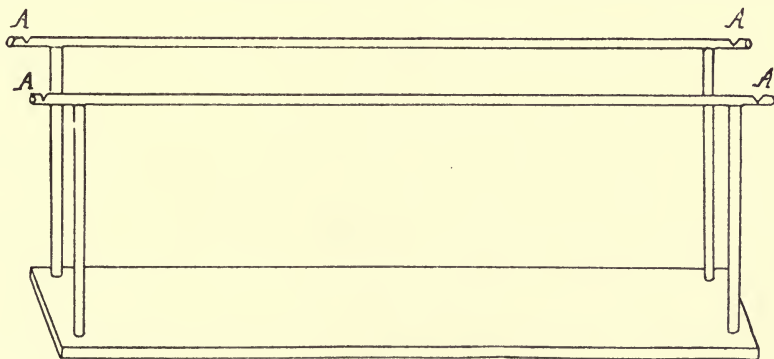

FIG. 465

off in his zeal. Now put the wire with the monkey in the middle across one end of the rails. Push the monkey head over heels and he will go on solemnly turning over and over, however long the rails are, until he lands in safety in the notches at the other

end. It is the bend in the wire and carefully balanced body of the monkey that makes him behave so delightfully.

The longer the stand is the better, for then two or three clowns, monkeys and cockatoos can follow each other rapidly.

The bars must be high enough to allow the monkey to turn

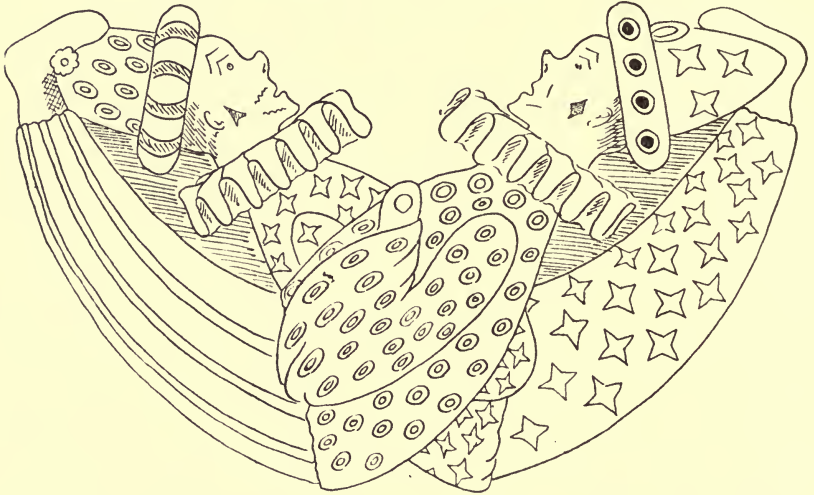

FIG. 466

without touching the ground— $4\frac{1}{2}$ inches high will just do if length of monkey from B to C (Fig. 464) is $4\frac{1}{2}$ inches.

Fig. 466 shows two clowns swinging together; a variety of funny figures can be made to follow each other along the bars.

CHAPTER XXIII

KITES, GLIDERS, AND AEROPLANES

Kites. Perhaps one of the easiest kites to make is one which the children of Annam and Tonking delight to play with. To make it, three light bamboo canes are required—about 2 feet in length—those used for flower-sticks will do quite well. Tie them strongly together as in Fig. 467.

The backbone $E F$ should be quite rigid, but the cross-pieces $A B$ and $C D$ are better if they are slightly curved. A sheet of

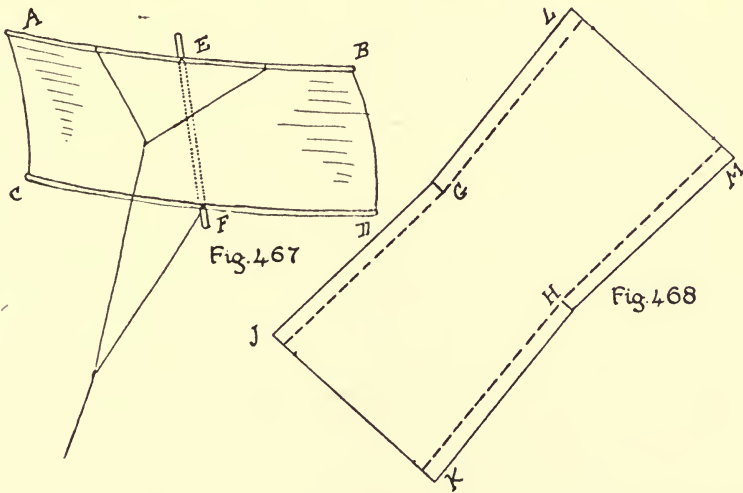

light paper must now be pasted from $A B$ to $C D$ underneath $E F$ in such a way that it is quite tight under $E F$, but rather loose between $A C$ and $B D$.

Fig. 468 shows how the paper should be cut. $G H$ is the exact distance between E and F ; $J K$ and $L M$ are wider than distances between $A C$ and $B D$ in Fig. 467, so that when the flaps on the

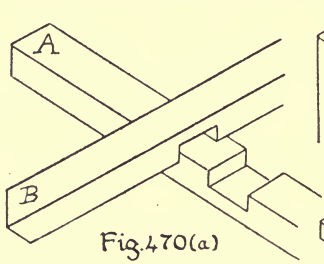

Fig. 470(a)

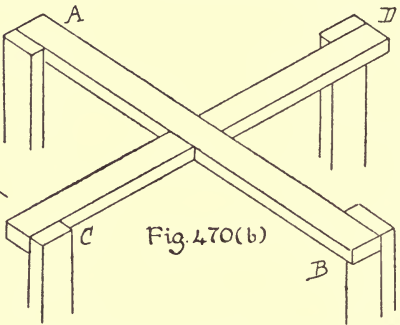

Fig. 470(b)

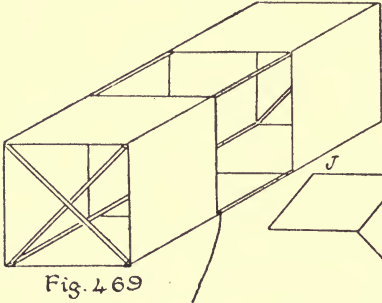

Fig. 469

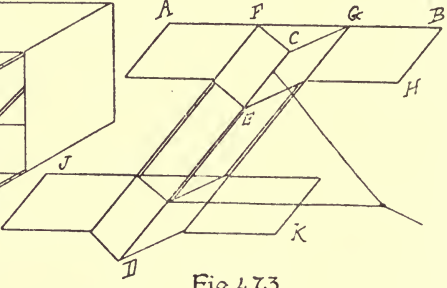

Fig. 473

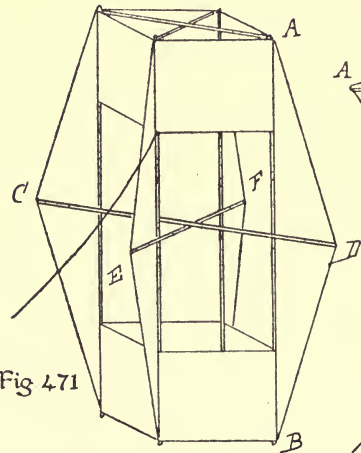

Fig. 471

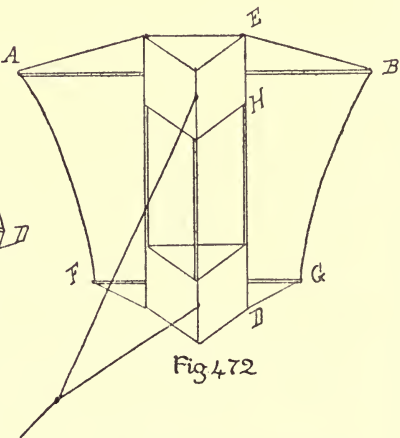

Fig. 472

paper are pasted over the cross-bits the paper is loose between A and C and between B and D (Fig. 467). The secret of the balance is to have the flutter at the edges quite equal. Fig. 467 shows how the string is fastened.

A Box Kite. This is a very common form of kite and quite easy to make. Take four laths from 27 to 30 inches in length and four pieces about 13 inches in length. The smaller pieces are fastened together with nails and glue, as in Fig. 470 (a) and (b). To the ends of these the long pieces are nailed and glued, as in Fig. 470 (b). Mark off the long pieces into thirds and over the two end thirds sew strips of light material. Tie on the string as shown in Fig. 469. This kite is said to be an American invention.

A similar kite may be made triangular in form.

Fig. 471 shows another form of the box kite. Here the material covers a little less than $\frac{1}{4}$ of the strip A B. Cross-bars E F and C D are tied across the middle and to the four sides, and wings are sewn on to them.

Figs. 472 and 473 are modifications of the triangular form of kite. In both these kites the long strips of wood are from $2\frac{1}{2}$ to 3 feet in length.

Notice that in Fig. 472, A B is the same length as D E, $FG = DH$; $EH =$ about $\frac{1}{4}$ of E D.

In Fig. 473 $AB = CD$. $CE =$ about $\frac{1}{4}$ of C D. FG equal about $\frac{1}{3}$ of A B. $FC = CE$. A H and J K are light frames of stripwood covered with calico. The diagrams show how these kites are put together.

A Chinese Kite. The kites used in China are very light and flimsy compared to our kites, as they are made of tissue paper and bamboo.

In making one it is better to use somewhat stronger paper. The paper is cut out as in Fig. 474, the two upper sides being slightly shorter than the two lower. Leave two rectangular pieces A, A, at each end of the shorter sides. A piece of split

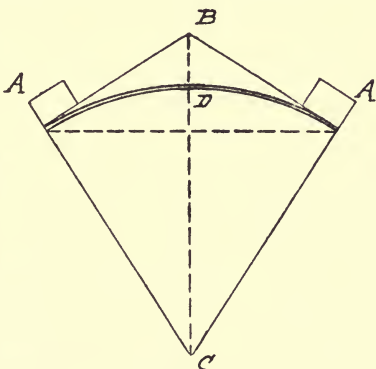

FIG. 474

bamboo, slightly flattened, is glued firmly to the paper from B to C. A second piece of bamboo tapering at the ends is used as a cross-piece D. This is bent as in the figure so that where it crosses the backbone, B C, it is only a few inches from the apex, B. It is tied to B C at D. Its tapering ends are pasted down to the paper by means of the two flaps, A, A. Bamboo B C should not be more than $\frac{1}{8}$ inch in width, piece D, $\frac{1}{4}$ inch. To prevent the paper getting torn in a good breeze, tie fine cotton round the border of the kite—*i.e.* from B to A, to C, to A, and to B again. Paste a thin margin of paper over the cotton, enclosing it, and to the kite. This must be done so that the face of the kite is perfectly flat; it must not bag in any way.

To fly the Kite. Much depends on the way in which the 'belly-band' is tied on. Its upper string is tied to D, and the lower to the backbone, B C, almost anywhere below a line from A to A. If the two strings are very near together, the kite behaves in a more lively manner, darting about in all directions.

The kite must be coaxed into the air by a series of jerks and pulls when the apex of the kite is facing upwards. It is inclined to turn round at first and some patience is required to learn when to pull and when to jerk. If one pulls at the wrong time it will dart down and then unless sufficient string is quickly let out, it will fall to the ground.

When once the kite is up, it does not keep stationary like an English kite, but is always darting about; a skilful flyer can make a kite dart down and almost touch the roof of a house at a great distance off, and then dart up again almost overhead.

It is not an easy kite to manage, but when once the art of flying it is mastered it is never forgotten.

Gliders. The earliest type of toy flying-machine consisted of a two-bladed tin propeller spun on a frame by unwinding string, as

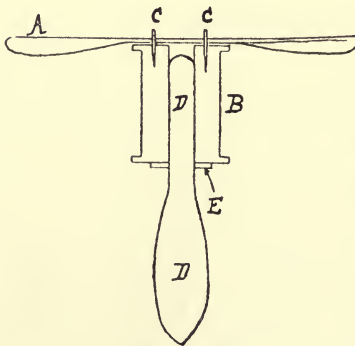

FIG. 475

with a top, and suddenly let go. It is easily made, as shown in Fig. 475, where A is a tin propeller nailed by nails c and c to a

large reel B. In making this toy the nails must be driven into the reel first, their heads are then cut off and they are tightly fitted into holes in propeller A. D is the axle on which the reel spins and the handle for holding it; E is a washer. This flying-machine is worked by smartly pulling a length of string wound around the reel.

Modern aeroplanes are far more difficult to make than this; they need patience, skill and experiment, and besides a knowledge of how to twist and bend wood by steaming it; plenty

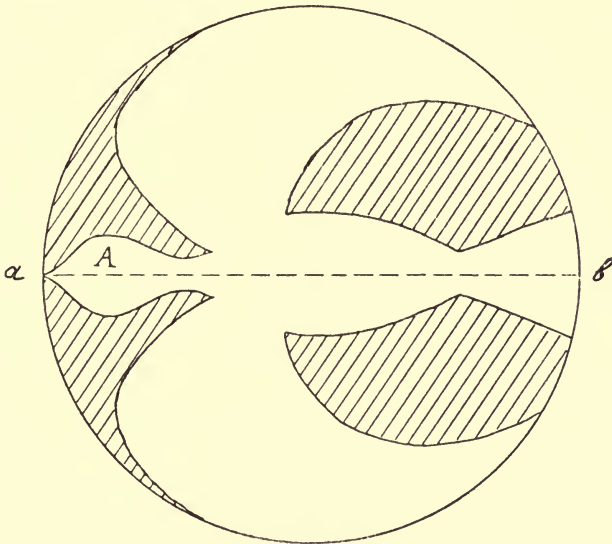

FIG. 476

of cane and whalebone wire, tissue paper or fine Japanese silk, and catapult elastic, which is generally the motive power used in working model aeroplanes. (Messrs Gamage, Holborn, W.C., stock skeins of specially prepared elastic.)

In this chapter only the simple and well-known types will be very briefly described, the boy who is interested must get special books on this subject from his library. In the first place the beginner must know what the three types of machines used in designing models generally are—viz. (1) the glider or motorless model, a glider being a winged structure, which when released from a height does not fall directly to the ground, but descends

gracefully at a gentle slope; (2) the monoplane, which is constructed more or less on the lines of a bird; and (3) the biplane or double-winged aeroplane.

Gliders may be either of the monoplane or biplane type. Experiments with gliders will enable boys to find out some of the principles on which aeroplanes are built, and will prepare them to undertake the construction of more difficult forms.

In making one's first glider one cannot do better than copy a bird. On a piece of paper draw a circle, fold it in half, draw a bird on one half, as in Fig. 476, cut it out, when the paper is opened it will appear as in the figure. If this bird is thrown head first toward the ground, it will probably fall. If two little bits of cardboard are gummed on each side of his head, he will make a better flight and land on the ground after making a gentle curve. A still better bird may be cut from cardboard, a half cut is then made along *ab* to bend it, and the head is weighted with sealing-wax. How well this bird flies depends on the weight, and to some extent on the shape of the bird. Birds of various shapes and with different amounts of sealing-wax should be tried, until one is made that glides to the ground in a long, graceful curve.

In making bird gliders the following points should be remembered:

(1) Draw the bird in a circle as already explained, this ensures that the wings will be exactly balanced.

(2) If the head in Fig. 476 is not long enough for a graceful flight, a longer head cut from cardboard can be pasted on.

(3) If the bird dives quickly down head first, you know that the head is too heavy, or the neck too long.

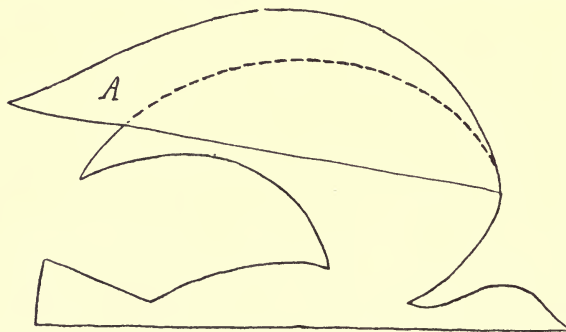

FIG. 477

(4) If the bird rises and then falls the head is too light and probably not long enough.

(5) The wings can be made larger if necessary by the addition of tissue-paper wings gummed on as A in Fig. 477.

Another Glider. Cut out a piece of paper 8 inches by 4 inches, A B C D in Fig. 478. Mark B E and D F each 1 inch; make cuts along the dark lines at E and F to the depth of 1 inch. Draw the broken lines along the paper, dividing it into four equal strips. Draw the broken lines along the paper, dividing it into four equal strips.

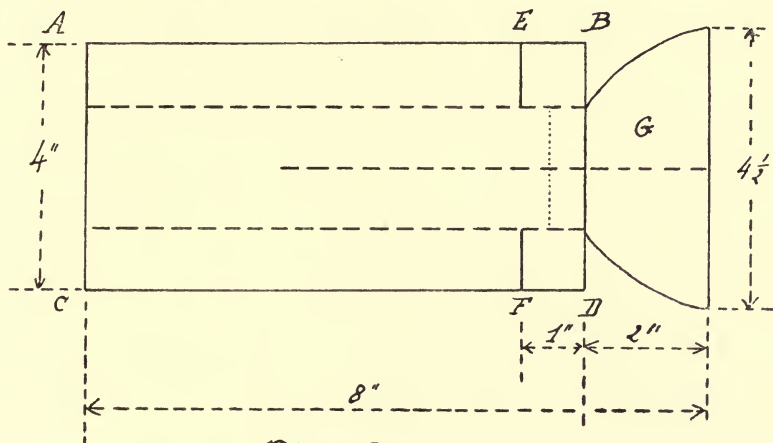

Fig. 478

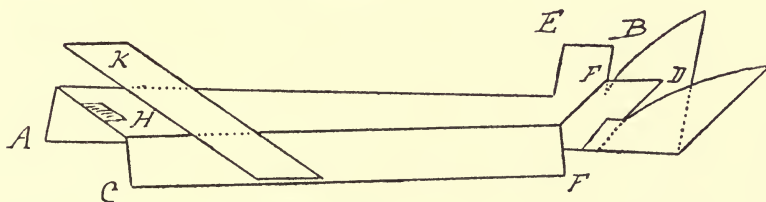

Fig. 479

Bend sides A E and C F downward along dotted lines. Bend E B and F D upward along middle dotted lines, and press side C F toward side A E, part way along this line, but leaving the part near the ends A C flat; to this end plane K will be gummed (Fig. 479). K is 6 inches by 1 inch. Cut tail, G, and gum on as in diagrams. It can be weighted at H by gumming several strips of cardboard across or by affixing sealing-wax. Although this is not a very graceful-looking glider it works most successfully, and will describe quite a graceful curve toward the ground.

The child will find it interesting to make a number of these gliders and then go one day to a window or high place and let them glide to the ground and thus find out the bird that has the longest flight. Or a number of children can have glider races and see who can make a glider that alights on the ground farthest from them. Other forms of gliders can be made, but they are all on the same principle, a somewhat long body, wings and weight adjusted to keep them from falling.

Fig. 480 shows a glider made from a dowel rod, with slits in it at each end through which two cardboard planes are passed and fastened. The cardboard must be of light weight and yet stiff enough not to flap. The size of the planes must be found by experiment, for their size will depend naturally upon the weight of the material used. The bigger plane should be in length about twice the smaller one. It is best to fasten the large plane on first and then adjust the smaller one to give a long, graceful flight.

If a split pole can be found it is an easy matter to fasten the planes in. Canes (bamboo) split readily and can be used as centre pole.

This glider can fairly easily be made into an aeroplane and worked with a propeller. It may be mentioned here that model aeroplanes are generally worked with the propeller in front and not in the rear.

To make Propellers. These can be made of tin or wood. A tin propeller can be cut from any old tin with a pair of shears or strong scissors kept for the purpose. Cut two blades to the shape shown in Fig. 481.

Next cut an oblong block of wood (Fig. 482); notice that width $a b$ in Fig. 482 must equal $a b$ in Fig. 481, therefore width of $a b$ must be a little less than $a b$ in Fig. 481. Slit each end diagonally as in Fig. 482 for about $\frac{1}{2}$ inch to hold the blades. Drill a hole through centre of block for the wire axle $d c$. Insert the blades in the slots, bend the ends over slightly and nail them in the wood to keep them firm. Fix the wire shaft firmly in the block as in Fig. 482. The propeller is now ready to be attached to the glider.

Before this is done, however, we shall consider the making of a wooden propeller. This is rather more difficult to make. Cut a piece of wood to the shape shown in Fig. 483 with a sharp

pen-knife. The propeller must then be given the correct twist by means of the steaming kettle. Take hold of the extreme ends of the propeller and hold it over the jet of steam so that steam plays upon the blades at each side of the thick central portion.

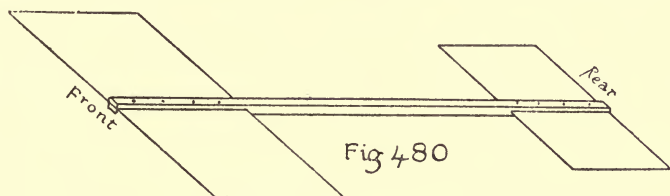

Fig 480

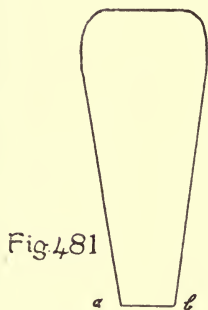

Fig 481

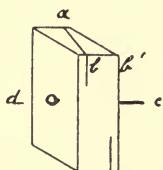

Fig 482

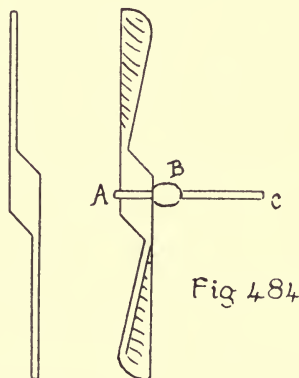

Fig 483

Fig 484

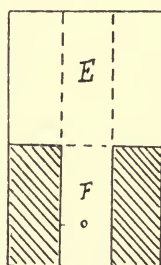

Fig 485

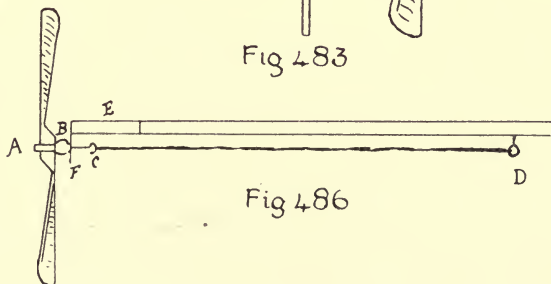

Fig 486

When the wood is supple, twist it as in Fig. 484. This sounds easier to do than it really is, the difficulty being to get the twist on one side exactly equal to the twist on the other. For this reason the tin propellers are more satisfactory to make. However suppose the correct twist has been given, the next thing to do is to sand-paper the wooden propeller carefully and file a groove around the middle at A; now wrap a piece of wire, A C, tightly

around the propeller in this central groove, and put on the head, B. The propeller is now ready to be fastened to the glider shown in Fig. 480.

To fasten Propeller to Glider. Cut a piece of tin to the pattern shown in Fig. 485, bend along the dotted line; make a hole at F for axle, B C, to go through. Bend portion E round the front end of the glider, keep it in its place by bending it with thread coated with glue; portion F with the hole is bent down at right angles as shown in Fig. 486. Now pass axle, A C, through hole F, bend end C into a hook. Put screw-eye D in the rod about one-third of length of rod from the other end (see Fig. 486). Fasten strands of elastic from hook C to D. It is best really to have a hook at D so that the elastic can be slipped over. The strands should be just loose enough to remain taut when unwound. When the propeller is in position the planes will probably have to be re-adjusted. The tin propeller can be attached in a similar way. These propellers will do for almost any simple design of aeroplanes.

When the motor is wound up for flight, the number of turns to give to the propeller will depend upon the strength and number of the elastic strands used. About a hundred turns is a usual number. Throw the motor forward in a slightly downward direction; because it is a glider it will tend to follow a gentle curve to the ground at first, but the whirling propeller will tend to carry it forward and upward. The first attempts may be failures, but these models are well worth many trials.

The Hawk Aeroplane (Fig. 487) is a common flying toy worked as the above by elastic. Cut two blocks of wood, A, A'; make holes in them as shown. Into the square holes fix and glue two square rods C. Through A' bore a hole for the piece of cane, B B', to pass through. F is a wire spindle with a hook at one end for elastic; it passes through the hole in block A', through two beads, and through a piece of cork, E, into which it must be fixed. K is a piece of cane bent as in diagram, passing through a hole in cork, H. The bend is more *permanent* if the cane is held to the spout of a boiling kettle; the ends of K should be slightly warped in opposite directions. Into block A another wire hook is fixed and bands of elastic are passed over this hook and the opposite one, as in the diagram; the more bands the better.

The cane B B' is bent round at each end and fastened to the

wooden rods, *c c*, by thread. The cane, *κ κ*, is fastened by thread as in the diagram; the thread can pass through a hole in the cork. Spaces *τ, τ, τ, τ* are covered with thin tissue paper gummed to thread and cane by means of overlapping edges. The model is wound up and set going like the previous one. Care must be

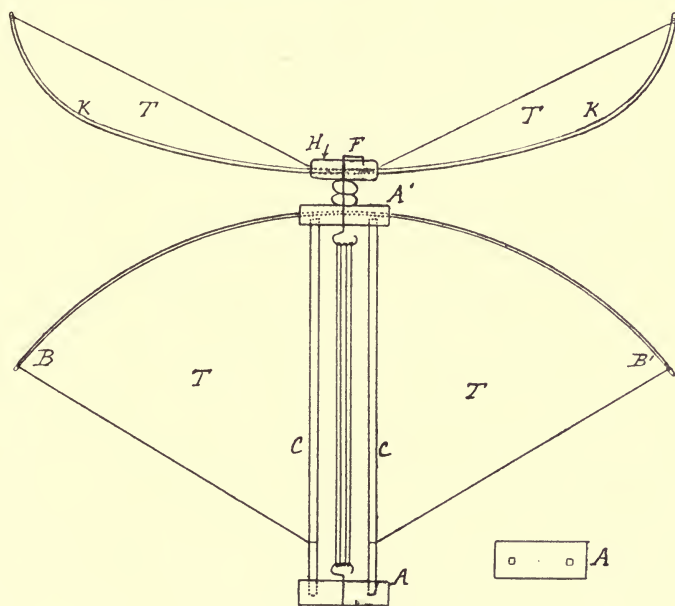

FIG. 487

taken to have it properly balanced, and it must be made as light as possible; the blocks *A, A'* may very well be cut from cork. Light bamboo cane can be used for posts, *c c*. At its best, however, the Hawk Aeroplane is not so good a flyer as the first model described.

An ambitious and clever boy who has once grasped the principles on which flying-machines are made can think out many models for himself and copy some of the more elaborate ones. The biplane makes a very effective toy, but is omitted here because it is somewhat difficult to construct.

CHAPTER XXIV

MORE OLD-FASHIONED TOYS

Jacob's Ladder. This is a very old and ingenious puzzle and an amusing toy. It is very simply made. A number of blocks

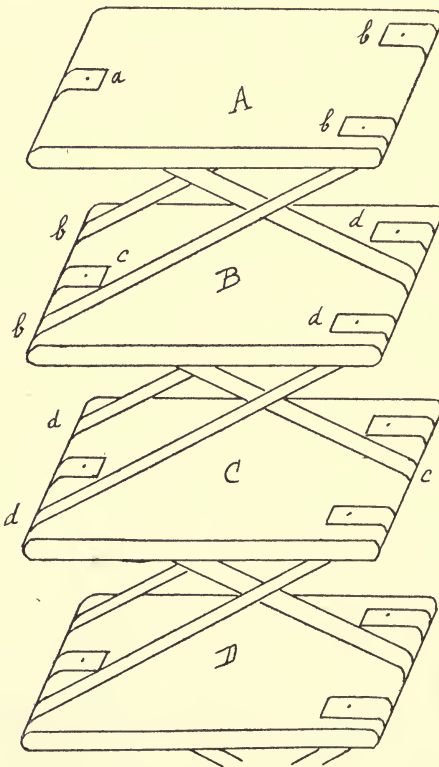

Fig 488

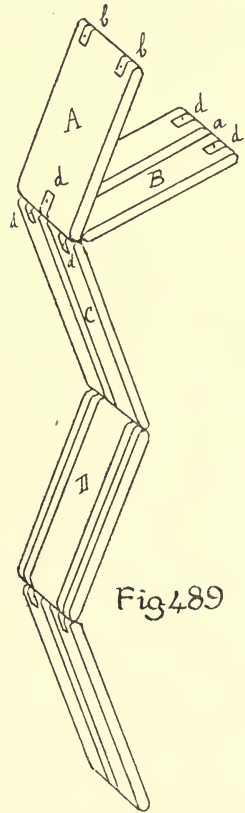

Fig 489

of wood must be made, $4'' \times 2\frac{1}{2}'' \times \frac{3}{8}''$. Any number may be used, but not less than seven; twelve is a very good number.

Round the edges of the blocks and make them smooth with sand-paper, as in Fig. 488. Cut strips of tape about $\frac{1}{4}$ inch wide and long enough to go over the rounded ends of the blocks, *a*, *b*, *b*, etc., in Fig. 488. There are three tapes to each block. Nail and glue tape *a* to the centre of upper end of block A; it is then brought over and downward under the middle of the lower end of block B and fastened.

Tapes *b b* are now fastened to the opposite end of A about $\frac{1}{4}$ inch from the end on either side, and are then brought round the opposite end of B, as shown in the diagram. The centre tape *c* is fastened to B and then brought down underneath to centre of the opposite end of c. The tapes must be arranged like this throughout the whole set of blocks.

Fig. 489 shows how the blocks are held when they are all complete. Top block A must be turned so as to bring the second block to the same level. The top of this block then falls, and it appears to pass rapidly down first on one side and then on the other, until it reaches the bottom. This is only what *seems* to happen. What really happens is that the second block becomes reversed and falls back again, in its former position. This makes it come level with the third block, which at once falls over on the fourth, and so on to the end of the ladder. A very illusive effect is thus produced. The blocks might be coloured with some bright enamel paint, contrasting colours on opposite sides.

The Trellis Toy (Fig. 490).
The strips of wood for this toy should be as thin as possible. They are fastened together at points 1, 2, 3, 4, etc., by small pieces of wire, or by rivets bent

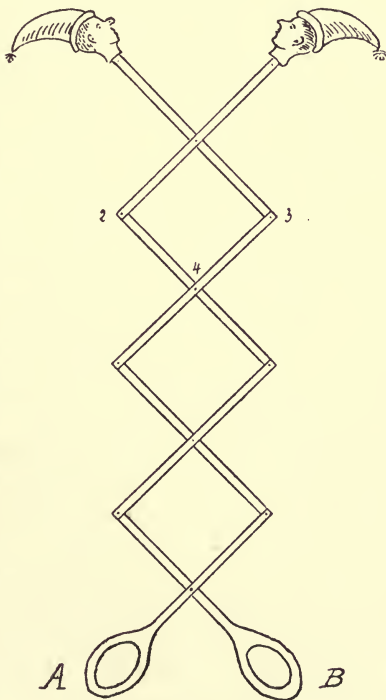

FIG. 490

262 TOY-MAKING IN SCHOOL AND HOME

down to prevent their slipping off, but not too tightly, so that the toy works easily. Heads can be cut out of cardboard painted and glued to the wood. Strips A and B should be wider at one end and have holes made in them for handles.

A Running Mouse. This toy is made of fret-wood, two ordinary reels and elastic.

Choose two reels of about $1\frac{1}{2}$ inches in length, diameter about 1 inch.

Cut out a piece of wood, A, to measurements given (Fig. 491). With a fret-saw cut out the head (Fig. 492); slit B is a little wider than the thickness of the wood, so that the head wags about very easily when wired to the body (Fig. 494). Cut out four legs as in Fig. 493. The reels work behind these so that the shape of the leg partly hides them. Nail the back legs to the body as shown in Fig. 494. Make a round axle to fit one of the reels so that it turns easily on it; cut it the exact length of the distance between the two back legs, pass it through the reel and glue its ends, C, to the legs so that the reel comes slightly below the legs and can run along easily. Now make holes, D, in the front legs, and nail them to the body so that holes D are on a level with the axle C. Make a hole through the body A, midway between the front legs, through which the string, E, will pass. Make holes in the other reel and insert wire staples at each end as in Fig. 495. Fasten to and wind round the reel about a yard of string. Pass rubber bands through each staple (F in Fig. 495) and through the holes D in the front legs and knot on the outside. Pass the string through the hole in A (Fig. 496).

To fasten Head on. Make two holes in the head exactly over each other, G and H in Fig. 492. Slip the head on to the body and make a hole through the body, between holes G and H, as shown in Fig. 497. Bend a piece of wire as in Fig. 498, distance between bent ends being equal to distance between holes G and H; slip the wire through the hole in the body, pass the ends of the wire through holes G and H, then bend the ends over to the position shown by the dotted lines in Fig. 498; the mouse's head will then swing from side to side. Make a hole in end at L (Fig. 494) and insert a tail of thick string. A piece of wood, M, shaped as in Fig. 494, may be glued along part of the body, A, a little to one side so as not to interfere with string, E. The whole may be suitably coloured.

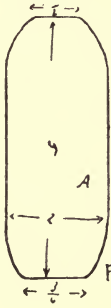

Fig. 491

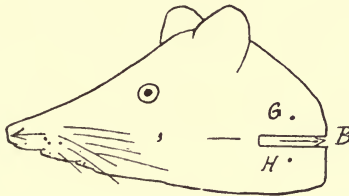

Fig. 492

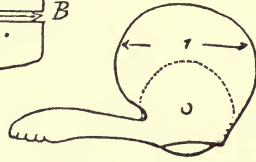

Fig. 493

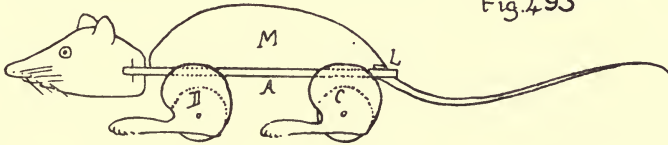

Fig. 494

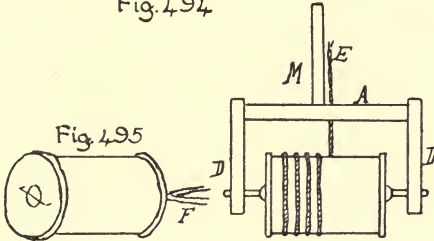

Fig. 495

Fig. 496

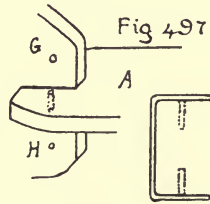

Fig. 497

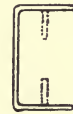

Fig. 498

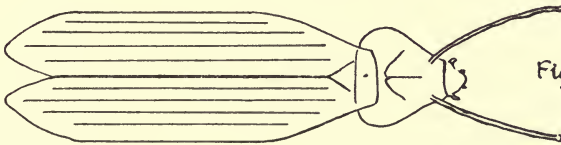

Fig. 499

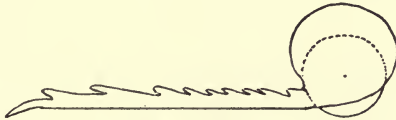
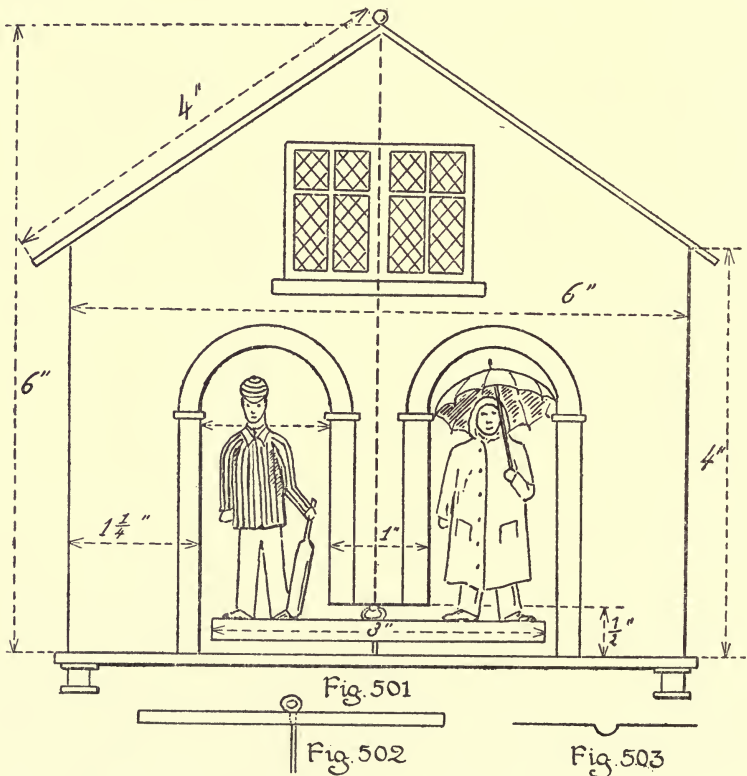

Fig. 500

The toy works in this way. If it is placed on the floor and the string held, the weight of the toy will make the twine unwind, thus causing the elastic which supports the reel to twist. When the string is slackened, the elastic will untwist again, making the reel revolve and the toy run along the ground.

Figs. 499 and 500 show a black beetle that can be made in the same way; the antennæ may be made of wire. Other suitable animals are a lizard and a crocodile.

A Hygroscope. The cottage is made of thin wood about $\frac{1}{8}$ inch to $\frac{3}{8}$ inch in thickness, according to measurements



given in Fig. 501. The sides are about $3\frac{1}{2}$ inches. The platform or floor on which it stands, $6\frac{1}{2}$ inches by 4 inches. The

sides of the roof are 4 inches by 4 inches, so that it projects slightly.

The doors in front are $1\frac{1}{4}$ inches wide and 3 inches high, and are cut out with the fret-saw; about half-an-inch of the partition between the doors is cut away to allow the disc on which the figures stand to swing round. Cut with fret-saw a circular disc of wood $\frac{1}{8}$ inch thick, diameter 3 inches. Drill a hole through the centre and fit into it quite tightly a piece of wire bent into a loop as shown in Fig. 502. Drill a hole in the floor of the cottage, about an inch from the middle of the partition. The wire axle should fit into this so that it turns easily, but not too loosely, otherwise the disc on which the figures stand will wobble. Just over this hole there must be another hole in the roof. This can be made by filing, with round fret-saw file, a little hollow (Fig. 503) in each of the top sides of the roof, so that when they come together a hole is formed. The back, sides, floor and roof may now be nailed and glued together. Next cut out from three-ply wood with the fret-saw two little figures as in Fig. 501; they should be about 2 inches to $2\frac{1}{4}$ inches, and should be suitably coloured. These are glued to the wooden disc.

The disc is hung from the roof by a piece of catgut; a knot is made at the end to prevent it slipping through, the other end being tied to the wire loop; the wire passes through the hole in the floor. The catgut must be long enough to allow the disc to turn round completely on its axis. Four pieces of wood or four small reels are glued to the corners of the floor to prevent the wire axle from touching the ground. The front must not be put on until the model is found to work correctly. To do this, hang the disc so that it is parallel to the ground, and so that both figures are looking out of their respective doors; then tie the knot at the top and wait for a change of weather.

Supposing on a damp day the cricketer comes forward and the boy in mackintosh and sou'wester retires indoors, this is because the catgut is twisting the wrong way, therefore the end that is fastened to the roof must be fastened to the wire loop, and vice versa. Now the front can be glued on. It can be suitably painted, showing door-posts, windows, bricks, etc.

Why the Hygroscope works. Catgut has the peculiar property

266 TOY-MAKING IN SCHOOL AND HOME

of absorbing moisture from the air and twisting up and becoming shorter ; when the air is dry it untwists to its original length ; the damper the air the greater is the amount of the twist. Hence in the model, as the catgut twists and untwists according to the state of the atmosphere, the little figures swing in and out of the cottage doors.

CHAPTER XXV

LIFT, PONT ROULANT, TOWER BRIDGE

A Lift. There are a variety of ways of making a lift. One of

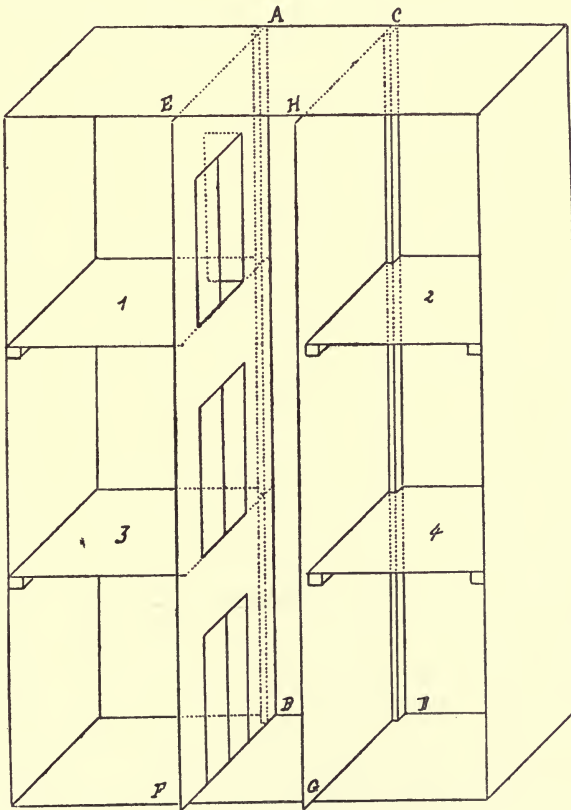

FIG. 504

the simplest is shown in this chapter. The first essential is a wooden box, oblong if possible, so that there can be many floors.

268 TOY-MAKING IN SCHOOL AND HOME

The measurements given in this chapter are for quite a small model made from a shallow oblong box, $9\frac{1}{2}$ inches by $14\frac{3}{4}$ inches, and about $2\frac{1}{2}$ inches in depth.

Sand-paper the inside and cover it with some pretty paper. Mark off distances $A C$ and $B D$ (Fig. 504) equal to $2\frac{1}{2}$ inches; rule lines $A B$ and $C D$ along the bottom of the box; glue pieces of stripwood $\frac{1}{4}$ inch by $\frac{1}{2}$ inch ($A B$ and $C D$ in Fig. 504) along the bottom of the box for the lift to run up and down between.

The lift is made next. Cut two pieces of wood $2\frac{1}{2}$ inches by $2\frac{1}{4}$ inches; nail to the corners of one piece four pieces of stripwood, $\frac{1}{4}'' \times \frac{1}{4}'' \times 3''$. Fasten the other piece of wood to these four posts by means of screw-eyes. Now leave the lift for a while.

Cut two pieces of cardboard, $A B E F$ and $C D H G$, to divide the box into three long divisions, as in Fig. 504. See that they project $\frac{1}{4}$ inch beyond the box. Divide these strips into three parts and draw and cut out doors as in the diagram; the line for the floors must, of course, be well above the top of the lift, while the height of the doors must correspond to that of the lift. Now glue these strips of cardboard to the pieces of stripwood $A B$ and $C D$ as in diagram; see that the doors open into the rooms on each side, and not into the lift.

See that the lift runs easily up and down between the cardboard strips; sand-paper it if it does not.

Make four holes in the top of the box, a, b, c, d in Fig. 505. Tie thread or black yarn to the screw-eyes, cross it and pass it through the holes as in the figure, then pass the four cables through screw-eye κ . When the lift is on the ground, pull the strings taut and tie a knot below the screw-eye. The lift can be raised by means of winding gear attached to the side as described in Chapter V, on the crane; the weight of the lift will pull it down again, or if this is not enough it can be weighted with lead.

Fig. 505 shows another way of working the model. Screw-eyes can be fastened to the bottom of the lift and thread tied to them as before; these threads must pass through four holes in the bottom of the box, through a hole in the support $L M$ and through screw-eye Q ; the bottom strings are then knotted to the top strings at R , and the lift can be lowered and raised by moving knot R up and down.

The supports $N P$ and $L M$ are made of pieces of stripwood $\frac{1}{2}$ inch by $\frac{1}{4}$ inch.

Cut a door out of cardboard as shown in Fig. 506 and glue it over the front of the lift. (In Fig. 506 the dotted lines are half cuts, the black lines are cut.)

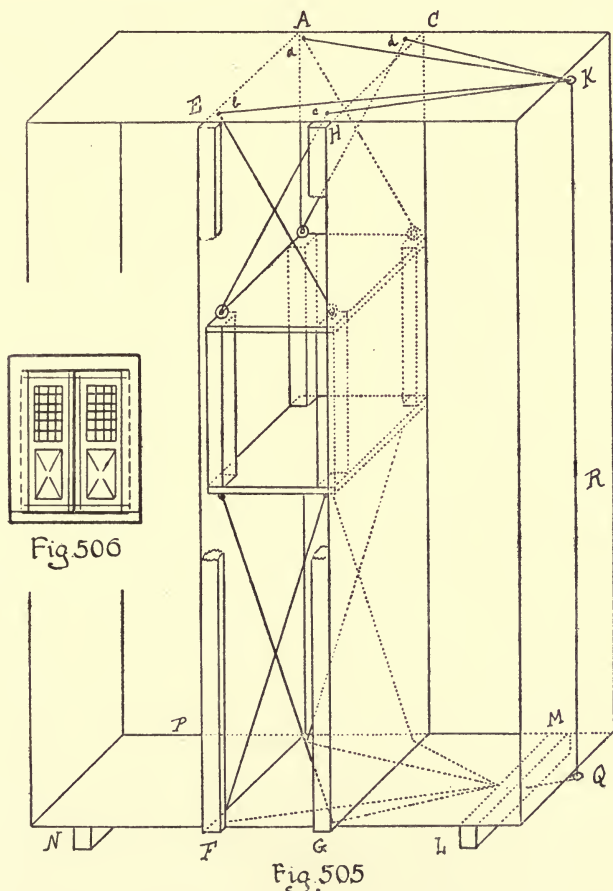

Nail strips of wood $\frac{1}{4}$ inch by $\frac{1}{4}$ inch, $E F$ and $H G$, in front of the lift and glue the pieces of cardboard to them. They keep the lift from falling forward. If the lift is moved up and down, as shown in Fig. 505, it is best for it to fit fairly tightly so that it fits into whatever position it is pulled.

270 TOY-MAKING IN SCHOOL AND HOME

Cardboard floors, 1, 2, 3, 4 (Fig. 504), are added, and kept in position by pieces of stripwood.

The rooms on each side can be furnished according to taste and according to their size. The lift itself may be finished off with advertisements, directions to travellers, etc., according as it is intended for use in a railway station, a hotel, a store, etc.

This toy, although so simply made, is very effective.

Pont Roulant at Saint-Malo. This is a pretty model to make. First glue four pieces of stripwood, $\frac{3}{8}'' \times \frac{1}{8}'' \times 4\frac{1}{2}''$, together (A A A A in Fig. 507). Nail and glue to the corners of this framework four round rods, $10\frac{1}{4}$ inches long and $\frac{1}{4}$ inch in diameter. Dowel rods such as these are somewhat difficult to nail on; however, should the wood of the little frame split, or the hole in the dowel rod be made too large for the nail, and so make the structure unsteady, the discs of cork (c in Fig. 507), which have a hole filed in the middle of them and are glued to the rods and the framework, help to consolidate the whole. Similar discs of cork are placed round the middle of rods, B, and at the tops of the rods. These serve to hold the black yarn which rigs the structure. The pieces of cork at the top have the additional advantage of making a steadier base for the platform to rest on. If the poles are not all cut exactly the same length, the discs of cork can be raised above the shorter poles and the platform on top made perfectly horizontal. These cork discs also give a larger surface to glue the platform to. Instead of dowel rods, iron wire $\frac{1}{8}$ inch in diameter can be used. These wire rods must have cork discs on them like the wooden rods, but they must be glued into holes in the lower framework and in the platform.

Having fixed the rods in position, thread is tied underneath a bottom piece of cork (c^5 in diagram), passed over the top of rod B^3 and kept there by the cork disc at the top, round the bottom of post B^4 and under the bottom cork, over the next post and so on, so that the threads cross each other as in the diagram. Thread is also tied round the middle of the rods just above corks c^1 , c^2 , c^3 , and c^4 . Thread is also tied from c^2 to c^3 , and c^1 to c^4 .

Pieces of stripwood, $\frac{3}{8}'' \times \frac{1}{8}'' \times 4\frac{1}{2}''$, are glued across the frame A A A A. Next the platform has to be made; this is a piece of wood $8\frac{1}{2}$ inches square and $\frac{1}{8}$ inch in thickness. Before gluing

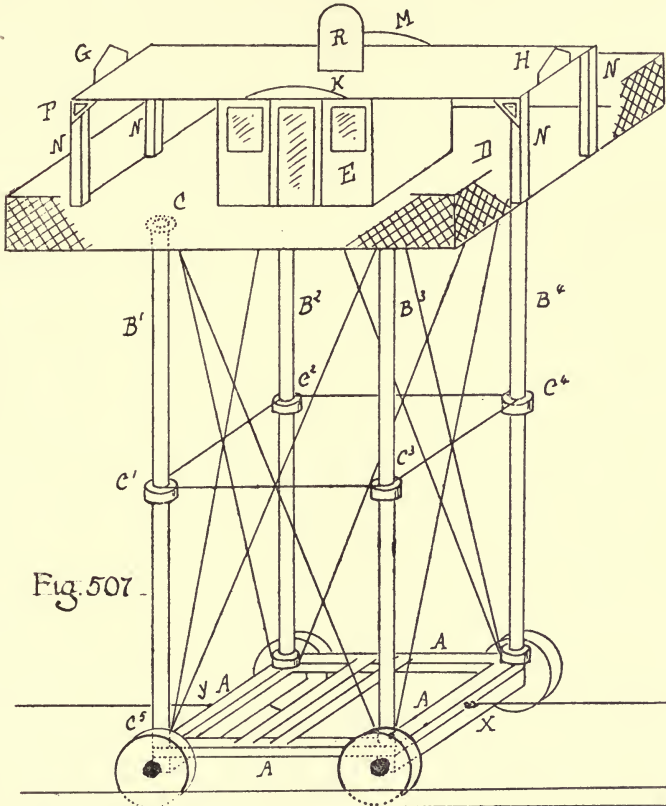

Fig. 507

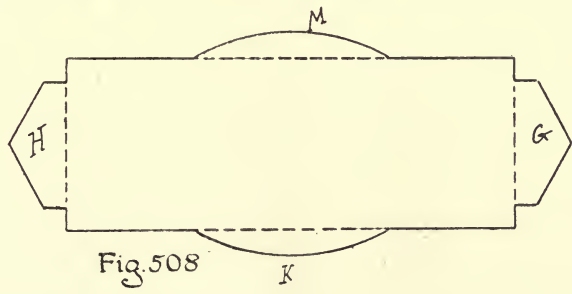

Fig. 508
K

it on to the four posts it is best to make and fasten to it the cabin, railings, etc.

The cabin, E, in the middle is 3 inches square and 2 inches high ; it is cut out of cardboard. Flanges must be left for gluing it to platform, and for gluing the roof to it. Doors and windows are drawn round it or cut out. The cabin is then glued in the middle of platform D.

The roof is a piece of cardboard $3\frac{1}{4}$ inches by $8\frac{1}{2}$ inches. Fig. 508 shows how it is cut out, half cuts are made along the dotted lines, and G, K, H, M are bent up to form the ornaments G, K, H, M in Fig. 507.

The roof is glued to the top of cabin, E, and to the tops of posts, N, which are pieces of stripwood $\frac{1}{4}'' \times \frac{1}{4}'' \times 2''$.

Triangular pieces of cardboard are glued in the corners, as P in Fig. 507.

The railings are 1 inch high ; they can either be made of strips of cardboard 1 inch by $8\frac{1}{2}$ inches supported at the corners and in

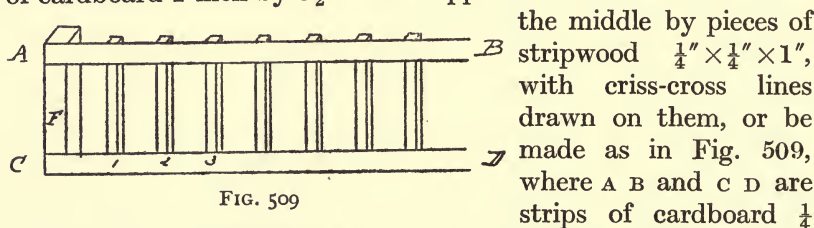

FIG. 509

the middle by pieces of stripwood $\frac{1}{4}'' \times \frac{1}{4}'' \times 1''$, with criss-cross lines drawn on them, or be made as in Fig. 509, where A B and C D are strips of cardboard $\frac{1}{4}$ inch wide, F is stripwood $\frac{1}{4}$ inch by $\frac{1}{4}$ inch, and 1, 2, 3, etc., are parts of match sticks glued to the cardboard strips. Seats can be placed round the railings, and round the cabin where there are no doors.

A piece of stripwood, R, $\frac{1}{2}'' \times \frac{1}{2}'' \times 1\frac{1}{2}''$, is cut and filed as in Fig. 507 and glued to the middle of the roof.

The platform is then glued to the tops of the posts with their surrounding corks. The frame, A A A A, is mounted on wheels $1\frac{1}{8}$ inches in diameter and $\frac{1}{4}$ inch in width. The axles are pieces of stripwood $\frac{1}{4}$ inch by $\frac{1}{4}$ inch, to which the frame A A is glued.

The rails on which it runs (*a b* in Fig. 507) are made in a similar manner to those described in Chapter XIII, for the transporter bridge. It is pulled along by thread tied to screw-eyes x and y, and wound up by winding gear similar to that described in Chapter XIII.

Fig. 510 shows how high tide can be represented by means of boxes and cardboard; D, E, F are boxes which form a quay into which the car runs. A, B, c are pieces of cardboard resting on pieces of stripwood glued to boxes D, E, F, and similar boxes on the other side, or the cardboard can rest on boxes. If boxes cannot be found big enough for D, E and F, several boxes can be built up. Slots *a b* and *c d* must be left wide enough for the supports

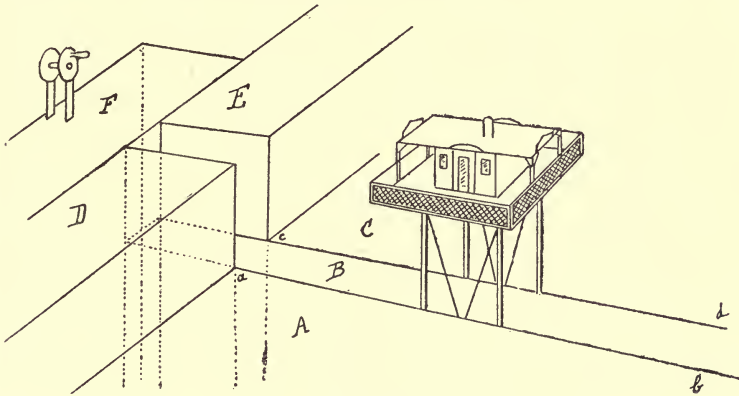

FIG. 510

to pass freely, and the threads must be omitted at front and back. The rails must lie exactly under slots *a b* and *c d*. The pieces of cardboard A, B and c should be coloured blue. The thread from the car underneath the "water" can pass into box F and up through a hole in the top, where the winding gear can be placed, but, of course, it can be worked from below. Sheets of cardboard A and c can be surrounded by boxes or fastened in a large box, or have cardboard walls built around it.

Tower Bridge. A very simple and effective model of Tower Bridge can be made, which will prove a delightful plaything.

The measurements given in this chapter need not be followed, but the bridge can be made larger or smaller according to taste. The whole structure can be of wood or of wood and cardboard.

Two small boxes are required, made of wood $\frac{1}{4}$ inch thick, about 4 inches in length, breadth and height. (If such small boxes cannot be found they must be made.)

Take off one side of box, A B C D in Fig. 511, which shows the

mechanism of the toy. Into the edges $D F$ and $c E$ screw two small screw-eyes, G and H , about $\frac{1}{4}$ inch from the top.

Now cut a piece of wood $8\frac{1}{4}$ inches long for the bridge. The width of bridge $a b$ must be equal to width of interior of box. For the present model it will be $3\frac{1}{2}$ inches.

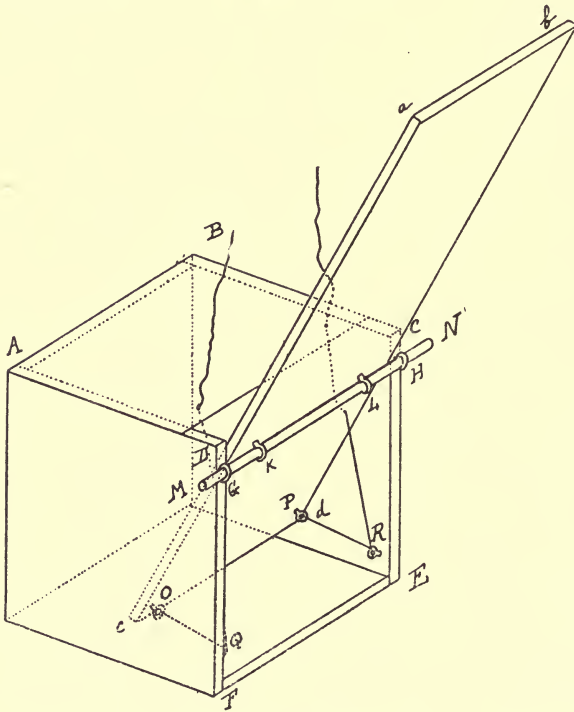

FIG. 511

The wood used for the bridge should be about $\frac{1}{8}$ inch thick.

Now rule a line $5\frac{3}{4}$ inches from end $a b$. On this line screw in two small screw-eyes, K and L , of the same size as screw-eyes G and H . The axle, $M N$, may be either iron wire (in which case the bridge may work rather loosely) or, what is better, a wooden rod that just fits the screw-eyes. Whichever axle is chosen cork discs should be placed at each end to prevent it slipping out. Before the bridge is fastened on, screw-eyes O and P are screwed in it near the end $c d$. Screw-eye P must be far enough from the edge $b d$ to

clear screw-eye R when the bridge is upright. The same with screw-eye O.

A piece of strong thread is tied to screw-eye P, passed through screw-eye R, and through a hole in the drawbridge above screw-eye R, but clear of axle, M N. A similar piece of thread is tied to screw-eye O, passed through Q, and through a hole in the bridge.

Now cover up top, A B C D, with a piece of cardboard, but do not bring this quite up to B C, in order not to interfere with the working of the bridge. Make holes in the cardboard for the strings to pass through. Then cover up the front portion, D C F E, below the bridge with cardboard.

The tower (Fig. 512) must next be made. This is formed of one piece of cardboard: height, *a b*, 9 inches; width, *c d*, $3\frac{1}{4}$ inches.

In the sides facing the bridge large openings, E, are cut about $2\frac{1}{2}$ inches high.

Small openings, F and G, about $1\frac{1}{2}$ inches high and $\frac{3}{4}$ inch broad, are cut for the overhead foot bridges. These are made of long pieces of cardboard 2 inches broad, bent in three divisions to form the path and sides. The latter are marked to represent railings. They should be long enough to pass well inside the tower through openings F and G, and through the corresponding openings in the opposite tower. They can be glued into position by pieces of stripwood or left movable.

A door, A, should be made in the top of the tower and a platform put in to make a compartment for working the bridge. The pieces of thread are brought up through holes in this platform and fastened to rod B, which passes through holes in sides of tower, and is kept from slipping out by cork discs. When this rod is turned the bridge will rise or fall.

If a large model is being made a proper little windlass with a handle can be constructed inside the upper room of the tower. The threads pass up on each side of the tower so as not to interfere with the "traffic" passing under the arch of the bridge. The tower is fastened up with flanges and glued to the wooden box with the help of small blocks of wood. A square pyramid is placed on the top of the tower, and the whole is suitably coloured. A picture of the real Tower Bridge is a great help when finishing off the model.

A similar bridge and tower are made for the other side.

276 TOY-MAKING IN SCHOOL AND HOME

To keep the wooden boxes the right distance apart (that is, so that bridge *x* just touches bridge *y*) nail or glue them to a long

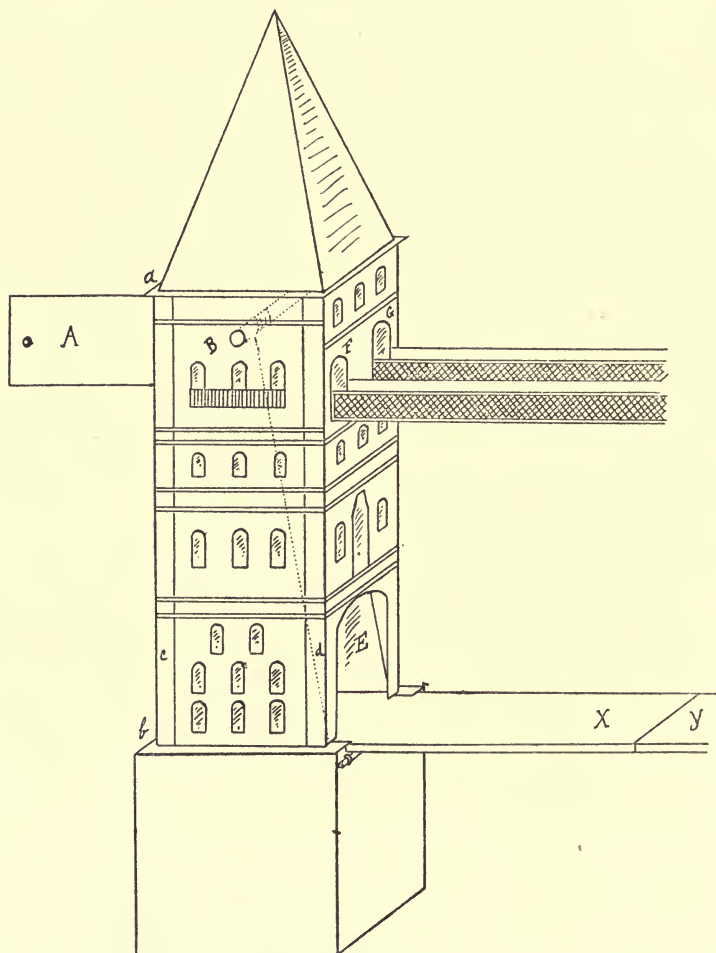

FIG. 512

strip of wood painted blue. There is, however, no need to fasten them permanently.

The ingenious toy-maker will find a hundred ways of improving this toy. There are many additions that can be made if a picture of the Tower Bridge is consulted; cardboard paths can lead to

bridge x, round the outside of the tower ; railings can be added to bridges x and y (but see that they are not in the way when the bridge goes up !), and so on. The method of raising and lowering the bridges is capable of a number of modifications. It should be the pleasant business of the maker to improve this model, and not be content with too slavishly following the directions given.

Bridges are among the most interesting things in the world, and there are countless happy hours in front of the little toy-maker who sets to work to collect pictures and written accounts of bridges, and who tries to imitate these.

CHAPTER XXVI

SOLDERING. SCREW STEAMER. TOYS WORKED BY WIND AND BY CONVECTION CURRENTS

Soldering. A knowledge of soldering makes many more toys possible, besides being a useful acquirement in itself. The following are the materials needed :

1. A soldering iron (Fig. 513). This can be bought for sixpence at any ironmonger's. It is best to get one not too long in the stem, as otherwise it is difficult to hold it steady.

2. A strip of soft solder, price about three-halfpence.

3. Soldering fluid or flux. This can be made at home from a pennyworth of spirits of salt (from an oil shop). Put a little of the spirits into a separate bottle and drop a few scraps of zinc into it. When it has stopped "fizzing" it is ready for use.

4. A pennyworth of resin.

5. A piece of sheet tin.

Soldering is not nearly so difficult as people think. There is one thing really essential for its success, and that is unlimited patience in cleaning the metal surfaces to be joined together. Solder will not adhere to dirty metal. The surfaces must be thoroughly scraped and cleaned with an old knife, then filed, rubbed with emery-cloth and protected by a coating of flux. The flux required for use should be kept in a shallow dish (*e.g.* a meat-paste jar), to prevent it being upset ; it can be put on with a small brush.

The copper bit of the soldering iron must be covered with a thin film of solder before any soldering is done ; this is to ensure that it is perfectly free from dirt or dust. This process is called "tinning the bit." It is quite simple. Heat the iron to a dull red heat, not quite red hot, as the solder would otherwise be destroyed. Then quickly file the four faces of the point to remove any dirt or oxide that may have got on it and which would prevent the solder from sticking to the bit. Next dip the bit for a second or two in

the soldering fluid and melt off a drop of solder on to the piece of sheet tin on which is put a little piece of resin. Turn the point of the bit round and round in the melted solder until it is completely coated. It is very important that the soldering iron should at no time be overheated, as this tinning would be burnt off; nor can it be repeated too often that the surfaces to be joined must be thoroughly cleaned; failure to do this is in most cases the cause of unsuccessful soldering.

To solder handle A to B (Fig. 514). Thoroughly clean that part of B to which A is to be fastened,

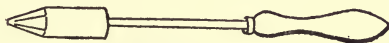

Fig. 513

and handle A, rubbing the edges of A with emery-cloth. Place A on B and rub a little flux with a brush along the join. Dip the bit into the flux and drop a spot or two of solder on the edges by applying the heated iron to the end of the strip of solder. Apply the bit to the solder and trail the solder with the point of the hot iron round the join so that it is filled up.

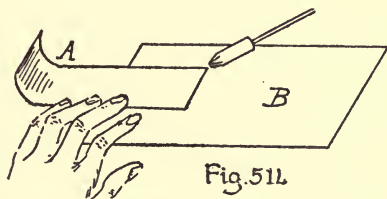

Fig. 514

A little practice will soon enable this to be done successfully, and the skill thus acquired makes the following toy possible.

A Steamer with a Screw Propeller. Fig. 515 shows the size and shape of the steamer. It should be about 4 inches wide amidships, $3\frac{1}{2}$ inches deep, and hollowed out as thin as possible, according to directions given in Chapter XIV. Fig. 516 shows the measurements for the stern. The bows should be sharp.

This boat must be fairly large to take the tube which runs through it. Fasten a strip of lead $\frac{1}{8}$ inch thick to the bottom of the keel. Paint the boat a suitable colour. When it is dry place it in the water and mark on the stern-post, A B (Fig. 516), the height to which the water comes, for the propeller must come just below this. Midway between this point and the end of the keel bore a hole, C, in the stern-post, through the boat in the direction of the top of the bow. This hole should be $\frac{3}{8}$ inch wide and can be made with a red-hot wire.

A brass tube must now be bought from a gasfitter's, $\frac{3}{8}$ inch

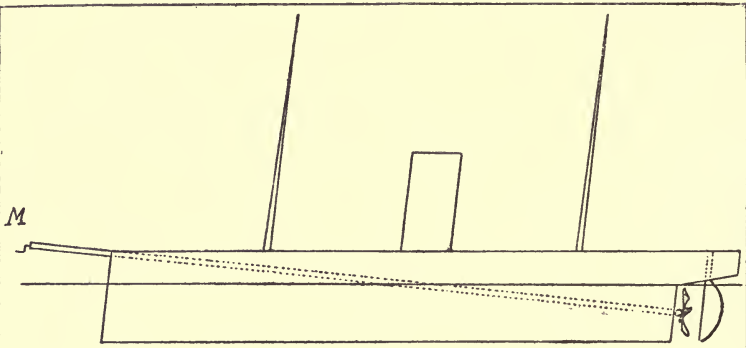

Fig. 515

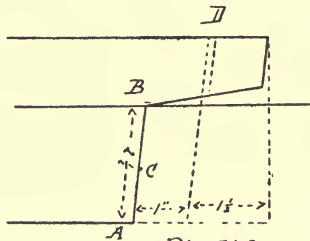

Fig. 516

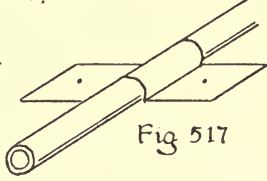

Fig. 517

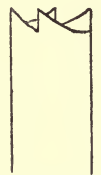

Fig. 518

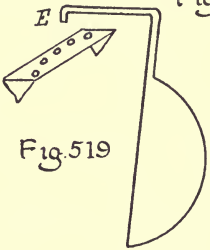

Fig. 519

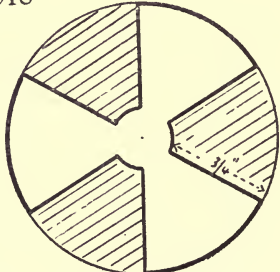

Fig. 520

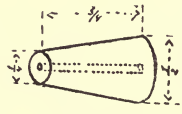

Fig. 521

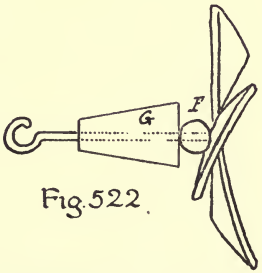

Fig. 522.

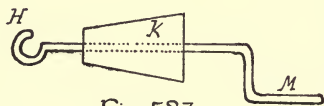

Fig. 523

outside measurement, and long enough to reach from *c* to about $3\frac{1}{2}$ inches beyond the end of the bow. Now cut a piece of tin $\frac{3}{4}$ inch wide and 2 inches long. Bend the middle of it round the tube and the ends outward (Fig. 517). Punch holes in each end. Solder this strip round the tube about $4\frac{1}{2}$ inches from one end. At this end file four teeth, about $\frac{1}{8}$ inch deep, as in Fig. 518. Now push the end that is not filed through the hole in the stern from the inside of the boat, so that it is flush with the wood, and fasten the other end to the stem of the boat by driving small nails through the holes in the strip of tin into the boat. To prevent water entering the boat put some putty round the tube where it passes through the wood. Before fastening the tube in the boat, round out the end of the bow slightly so that the tube will rest securely on it without projecting too much above the gunwale. Make the deck and fix it as described in Chapter XIV. Bore a hole, *D*, in Fig. 516, near the stern right through the deck so that it comes out under the counter about 1 inch from the stern-post. It should be large enough for a piece of stout wire to pass through. This is for the rudder.

To make the Rudder. Cut a piece of brass wire about $\frac{1}{8}$ inch thick, $6\frac{1}{4}$ inches long. Cut the rudder out of tin and shape as in Fig. 519. Solder it on to the wire so that the end of the rudder is flush with the end of the wire. Pass the wire through the hole, *D*, and bend as in Fig. 519. Cut a strip of tin about $\frac{1}{3}$ inch in width, punch holes in it, point the ends, bend them over and fasten them into the deck so that the strip is under the bend, *E*, of the tiller. Press the tiller over and into one of these holes; thus the rudder can be held firm in its required position for steering.

In the middle of the deck cut a hole about $\frac{3}{4}$ inch in diameter for the funnel, which is a tube of tin about 4 inches long.

The Propeller. Cut a circle of tin 2 inches in diameter and inscribe a hexagon; cut as in Fig. 520, the shaded portions being cut away.

Punch a hole in the centre and into this fix, by soldering, a piece of brass wire ($\frac{1}{16}$ inch thick), 2 inches long, to form an axle. Warp the fans of the propeller out of the plane of the circle about $\frac{1}{4}$ inch. Make two pieces of wood shaped as in Fig. 521. Bore a hole through each and by filing with a small round fret-saw file enlarge it to $\frac{1}{16}$ inch.

Put a glass bead, *ф* (Fig. 522), on wire of propeller, and put the wire through one of the pieces of wood, bend the end into a small hook. Take another piece of wire, pass it through the second piece of wood and bend it as in Fig. 523. Now take a piece of strong elastic, $\frac{1}{4}$ inch wide and about $3\frac{1}{2}$ feet long; tie the ends together. This must be passed through the tube in the boat. To do this, tie a piece of string to the elastic, and drop the string through the tube from the stern end, and by means of the string pull the elastic through, first hooking one end of it to the hook on the propeller wire, Fig. 522. Then push the piece of wood, *г*, into the tube, so that the screw clears the rudder. Now hook wire, *и* (Fig. 523), into the elastic, and push wood, *к*, into tube. The wood must be cut away so that the handle, *м*, can catch in the teeth of the tube.

To make the boat work, hold the propeller steady with one hand and wind up the elastic by the handle, *м*; put the handle in one of the teeth to keep the elastic twisted; set the rudder, put the boat into the water, let go the propeller and the boat will go on until the elastic is unwound. Instead of one band of elastic, several thinner bands may be used, and more motive power can thus be obtained.

Toys worked by the Wind. Cut out of fret-wood ($\frac{1}{8}$ inch thick), or three-ply wood, a man reading a paper with one foot raised and resting on a box.

The man should be about $5\frac{3}{4}$ inches and his raised foot 1 inch from the ground, as in Fig. 524. The shoeblack is cut out in three pieces. First the kneeling portion, *а* (Fig. 525), is cut 2 inches high and a hole made at *b*; then the head with part of the arm to the elbow attached, as *и* in Fig. 526, about $1\frac{3}{4}$ inches high, and with holes at *d* and *e*; then the hand (with long shoe-brush) and arm to elbow, as *к* in Fig. 527; make a hole at *f*. Length of *к* $2\frac{1}{4}$ inches.

Now join *к* to *и* by wire or a rivet through holes *f* and *e*, so that it swings loosely, then join *и* to *а* by a wire through holes *d* and *b*.

Colour these two figures suitably.

The base on which the figures rest is a piece of wood about 12 inches by 3 inches. The next thing to be made is the mechanism that works the figures. First cut a piece of stripwood $\frac{1}{4} \times \frac{1}{4} \times 7$, *а* in Fig. 524. The fan or propeller, *в*, is made by cutting a small circular piece of wood or cork about 1 inch in

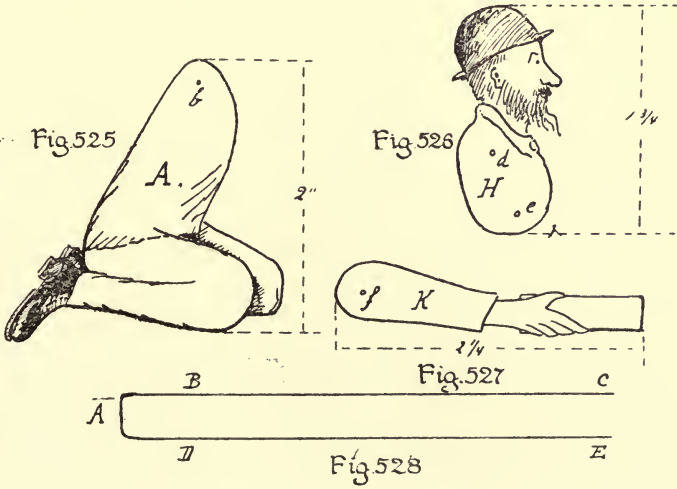
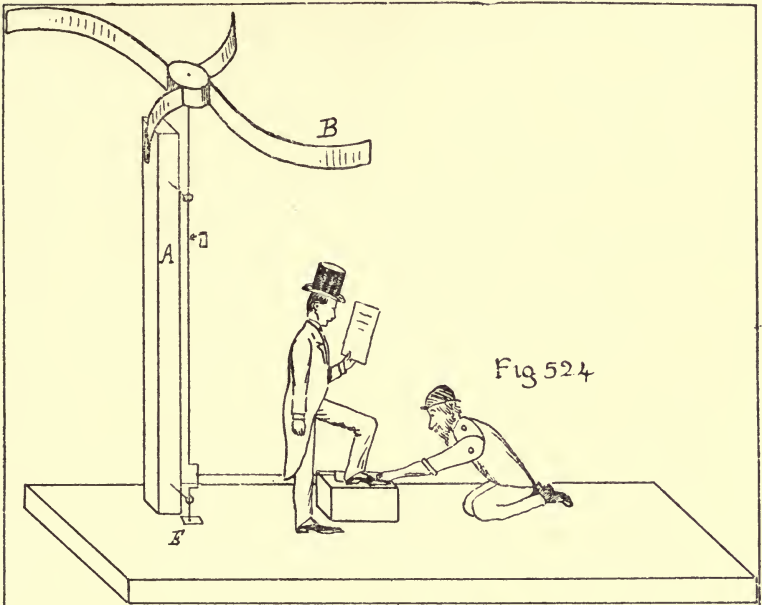

284 TOY-MAKING IN SCHOOL AND HOME

diameter and securely fixing round it five wind flaps as shown. These flaps are best made of tin.

Now get a piece of stout copper wire (about $\frac{1}{16}$ inch thick), *D* in Fig. 524, and bend it as in diagram. The best way to effect this bend is first to make a sort of elongated **U**, as in Fig. 528; this can be done with pincers. Then put part *A* in a vice and bend *B C* and *D E* out at right angles. Cut it the right length so that the bend will come on a level with the shoeblack's brush and one end will come above post, *A*. The wire, *D*, should be pointed or well smoothed with a file at the lower end, so that it will turn easily on a piece of glass glued to the base.

Wire *D* is supported by two wire hoops or screw-eyes placed in post *A*. The holes through which it passes must not be too large or it will wobble and not turn smoothly. Now all the parts are ready for putting together. Glue the shoeblack on first, then opposite to him the man. See that the brush passes over the shoe. If for any reason this does not happen, a larger brush can be cut from wood or cardboard and pasted over the shoeblack's hand. Now fasten post *A* behind the man so that the bend of the wire, *D*, will be in the right position; pass wire, *D*, through the wire loops or hooks (these are best made of copper wire); glue the top of it into the hole in the propeller. Glue a piece of glass, *E*, under the other end. Connect by a thin piece of wire the shoeblack's brush with bend in *D*. The figure will now work well in the wind.

The shoeblack is the toy one most often seen worked in this way. A man sawing wood is another favourite model, and can be made in exactly the same way.

Two knights fighting can also be made; this involves, however, two propellers.

Toys worked by Convection Currents. These are less interesting toys because they do not admit of much variety. The toy is worked over a gas burner, where it acts as a ceiling protector. As the power available from convection currents is very slight, every care must be taken that the figure will work smoothly.

As the toy is exposed to heat, the soldering must be well done. Fig. 529 shows how the toy is made.

The little sailor is cut out of sheet metal (tinned plate); his limbs are fixed by means of rivets or eyelets (the latter are obtainable at a boot repairer's). Take care that they move freely.

They will do so if the holes are very smooth. The wire used is steel wire about $\frac{1}{16}$ inch ; this is fairly easy to bend.

Wire A B is bent as already described in the shoeblack. It passes through loops in the wire at A and D. It is kept from slipping through at A by a ring of wire soldered on the top.

The propeller at B is simply a tin disc with radial cuts, each sector being twisted at an angle by a pair of pliers. The propeller is held by a turn in the wire and by a touch of solder. Notice that the feet of the figure are turned round the wire on which it stands. They can be soldered for greater security. The hand is also curled round the crank pin, but it must be free to turn on it.

The wire framework, E, is soldered to a circle of tin, c, which fits on the top of the lamp. As the figure has to be small it should be as long as possible.

A pair of scissors should be kept for cutting tin, or tinman's snips can be used ; cutting pliers and centre punches will also be needed. Holes, however, can be punched in tin with strong round nails and a hammer. Round files are needed for making holes smooth.

Empty tin canisters form a supply of tin plate.

Adjustable cycle spanners are useful for bending wire at right angles ; a hide mallet is a great convenience.

Before making a toy like one of those described it is well to practise bending wire with vice, hammer and mallet.

In the last toy, if tinned plate and tinned steel wire are used, the soldering is a fairly easy matter, because the tinning has already been done.

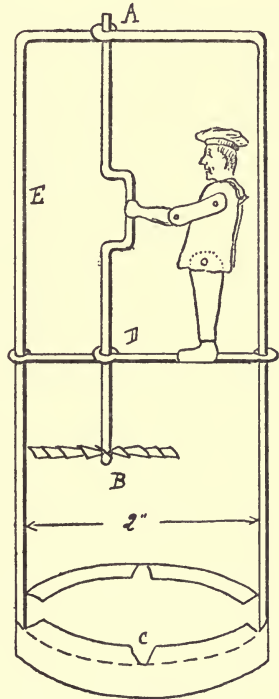

FIG. 529

CHAPTER XXVII

BUILDINGS AT HOME AND ABROAD

A Farmhouse. Young children, having cut out of cardboard or fret-wood the animals and trees described in Chapter XX, having constructed a bridge, a well, a dovecot, and other small models scattered through this volume, take considerable pleasure in arranging their toys into pretty groups and attractive combinations. At this stage the lack is often felt of some object of central interest, of something to 'pull the composition together,' as an art critic would put it: the farm scene requires a farm, the domestic scene a villa, the Eastern animals and trees an Indian temple, or some such building, to complete the picture.

With regard to home scenes, children may be advised at this stage to make for themselves any house or building that suits their fancy. The basis of the toy will always be the four walls plus a roof described in the Noah's Ark (Part I, Chapter X); more complicated cardboard work has already been studied in the castle (Part II, Chapter X), so children who are ambitious to achieve something more picturesque than the Noah's Ark may be advised to go out into the suburbs or the country, and sketch any simple building, or set of buildings, which they would like to reproduce. Such work, once attempted, becomes extremely fascinating, and leads to very picturesque and delightful results. To do really good work, however, children must accustom themselves to *plan* very carefully what they propose to do, and to convert their sketches into a set of drawings to scale, which, in the case of a building, should include at least a ground plan and a couple of elevations.

Figs. 530 and 531 show how to lay down the plan and elevations of a simple building of the 'Noah's Ark' type, to which have been added a front and a back door, with porches, bay and storm windows, chimney-stacks, and an outhouse at the back. Fig. 532 is the front elevation to half scale.

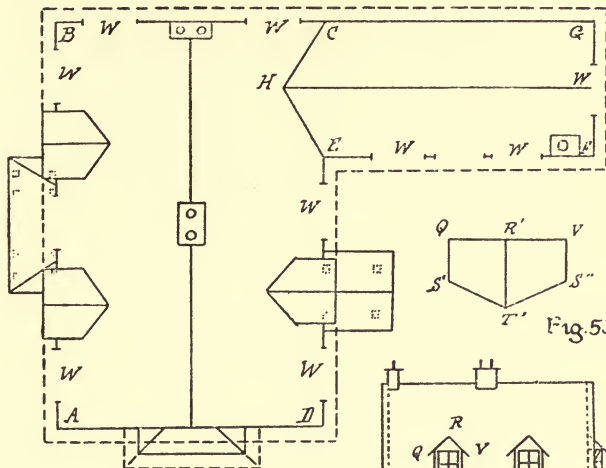

Fig. 530

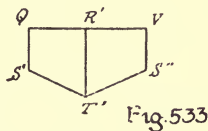

Fig. 533

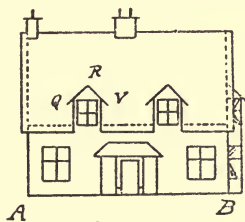

Fig. 532

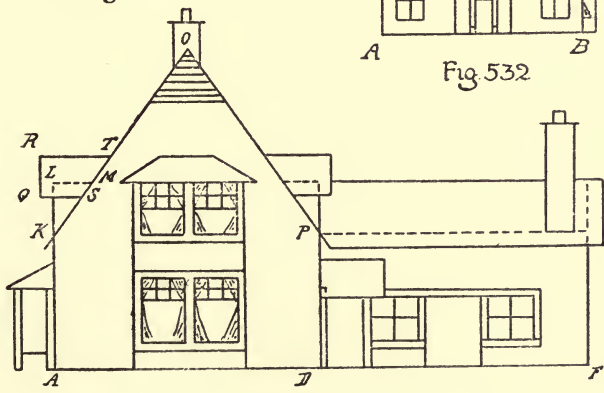
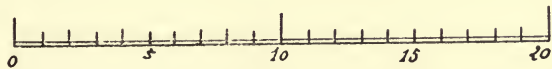

Fig. 531



The addition of another entirely detached outhouse with wide door at one end, for a cowshed, to face the back of the main building and form the third side of a square, will give the nucleus of quite an attractive farm.

When once the plans have been drawn, a scale is plotted below to suit any size to which it is intended to build ; all the dimensions shown in plan and elevation are then taken as required with dividers, read off on the scale, taken anew on a foot-rule, and transferred to the wood or cardboard.

The scale given on the figure is for quite a large house, the ground plan of the main building measuring 15 inches by 10 inches, and that of the outhouse 10 inches by 5 inches. These two buildings had best be constructed on separate bases, and need not be permanently joined ; the roof of the outhouse can be carried rather further into that of the main building than is indicated by the line CHE , and the main roof alone cut carefully to the line CHE . If the main roof is made detachable, building $ABCD$ will form a receptacle for the outhouses and the whole farm stock. The broken line surrounding $ABCD$ and $CEFG$ indicates the dimensions.

A house of this size is best built with a base and walls of wood obtained from some grocers' boxes.¹ If the scale be marked so that points 0, 10, 20 read 0, $7\frac{1}{2}$, 15, giving a reduction to three quarters, the main building will measure $11\frac{1}{4}$ inches by $7\frac{1}{2}$ inches, and may be built entirely of cardboard. If the scale be marked so that points 0, 10, 20 read 0, 5, 10, AB and AD measuring respectively $7\frac{1}{2}$ inches and 5 inches, we shall have a small model that can be built of very light materials, such as stout cartridge paper on a cardboard base.

The bay window will, of course, be made separately, and gummed into position by means of flanges. The porches may be detachable, like the outhouse ; the front-door porch is built of eight pillars of stripwood, nailed and glued to a wood or cardboard base and to cross-beams above ; between the pillars may be fixed a couple of seats, one on each side of the door. The back-door

¹ An excellent and very strong material for model-building is manufactured by Messrs James Spicer and Sons Limited, under the name of Rough Cast Building Board. It has a most realistic white 'rough-cast' surface. It is obtainable in the size $18\frac{1}{2}$ inches \times 24 inches from Messrs Richardson and Co., Stationers, 176 Charing Cross Road.

porch is supported by four pillars. The roofs are of cardboard. The ground-floor windows, indicated at *w*, may be either painted or cut out ; in the latter case they may be made to open or may be fitted with celluloid window-panes ; these you can beg from any amateur photographer of your acquaintance ; he is sure to have plenty of ' waster ' films. The doors should, of course, be made to open.

The storm windows are easily made ; the sides, *K L M*, are cut with angle $\angle L K M = \text{half the angle } K O P$, the latter being in the present instance 72° . The shape of the window roofs can be arrived at by experimenting with a paper template, but more accurately by plotting them out to scale.

Thus : draw $Q' R' V' = Q R V$, $R' T' = R T$, $Q' S'$ and $V' S'' = Q S$; join $S' T'$ and $S'' T'$; then $Q' V' S'' T' S'$ (Fig. 533) is the exact shape (leaving the flanges out of account) to which the storm-window roofs should be cut. The roofs over the front porch and the bay window, the chimney stacks, etc., are thought out and plotted in the same manner, the solving of these little problems being excellent practice, which may be turned to good account in after life.

The village church, the village inn, if it is old and picturesque, should form good subjects for study and reproduction on the lines indicated above. For young people who have exhausted the possibilities of their immediate surroundings we give a few models from lands more remote.

The Taj Mahal, Agra. This is one of the most famous buildings in India, and was erected by the Emperor Shah Jehan over the body of his favourite wife. A very pretty model which closely resembles it can be made as follows :—

In Fig. 534 the dome, *A*, is a plain india-rubber ball, circumference about 11 inches. Four india-rubber balls, circumference about 6 inches, are needed as *B B*, and four, circumference about $4\frac{1}{2}$ inches, for the four columns (*c* in Fig. 534) which surround the temple. Cut a piece of fairly thick cardboard, 7 inches square, for the roof of the temple. Cut off the corners as in Fig. 535. In the centre describe a circle with radius $1\frac{3}{8}$ inches, and round it four smaller circles of radius $\frac{7}{8}$ inch.

Cut a strip of thin cardboard 9 inches by 2 inches. Cut as in Fig. 536, leaving flanges of $\frac{1}{2}$ inch. Roll round and fasten together

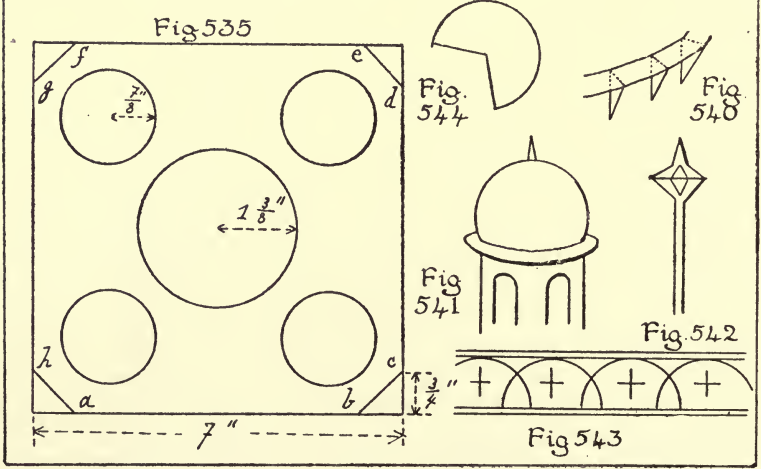
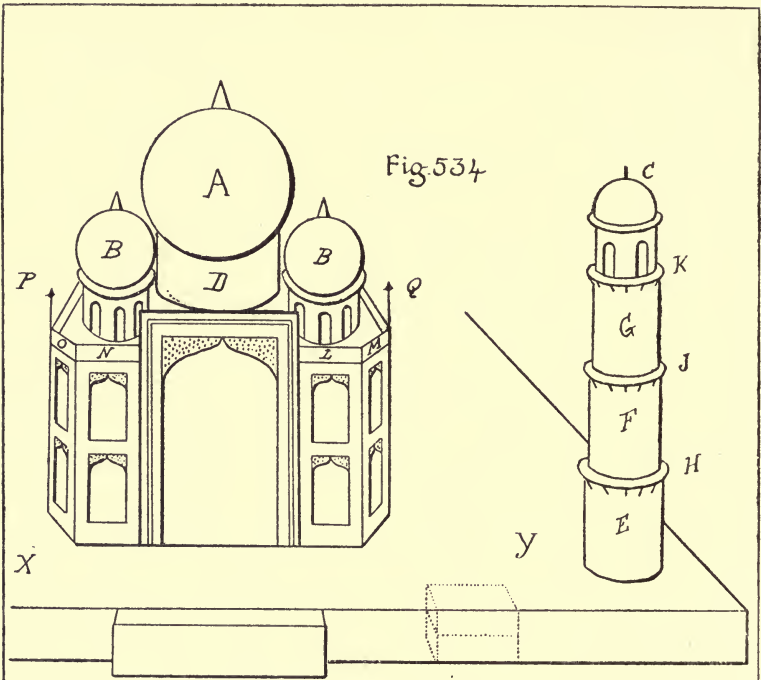

with secotine and two small paper-clips, size 00. This forms the part of the temple marked D in Fig. 534. It is glued to the roof by the flanges, etc., and ball, A, is glued into it.

Before fastening it together, mark on it in ink the pattern indicated in Fig. 536.

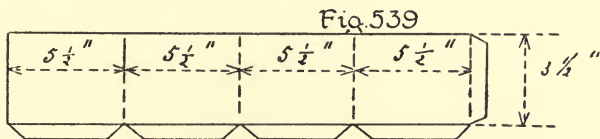
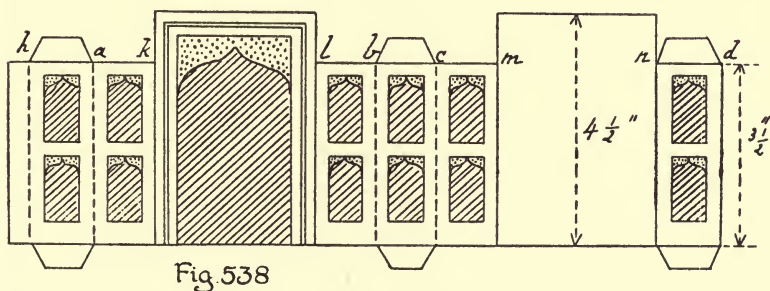
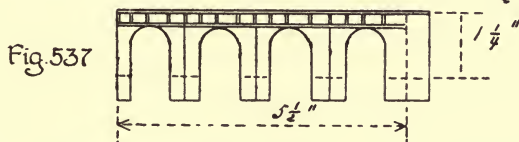
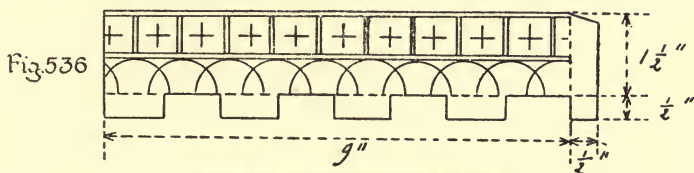

Cut four strips of thin cardboard $5\frac{1}{2}$ inches by $1\frac{1}{4}$ inches; mark off $\frac{1}{4}$ inch for flanges; cut each as in Fig. 537; bend them round and fasten together; glue the smaller balls, B, B, into them and glue them on the roof just over the smaller circles.

Cut four strips of cardboard 5 inches by 1 inch; cut and mark as in Fig. 537, and glue this round the smallest balls, c. Measure distances *ha*, *ab*, *bc*, *cd*, etc. (Fig. 535), on a piece of cardboard, and mark out as in Fig. 538. Make half cuts along the dotted lines and leave flanges as shown. Distance *ak* = *ah* and *lb* = *bc* = *cm* = *nd*.

Make and cut out the windows and arch.

Cut another piece of cardboard similar to this. These two bent round and joined together form the sides of the temple.

Now cut a piece of cardboard as in Fig. 539, leaving flanges all round.

Bend it round and gum it together. This is gummed underneath the roof, before fastening on the outer walls, and serves a double purpose; it helps to support the roof on which the domes rest, and prevents the temple from looking too hollow when the windows are cut out.

To make Tower, c e (Fig. 534). It consists of three rolls of thin cardboard, e f g, each about 2 inches high, circumference $4\frac{1}{2}$ inches.

Circular pieces of cardboard, big enough to project about $\frac{1}{4}$ inch beyond the columns, form the platforms, h, j, k. Underneath each platform triangular pieces of cardboard are glued, as in Fig. 540. Four of these columns stand round the central building.

It is a great improvement if rings of cardboard, $\frac{1}{4}$ inch wide, are made and glued round all the smaller domes, as shown in Fig. 541.

Round the sides of the building strips of paper, l, m, n, o (Fig. 534), are gummed, rising about $\frac{1}{2}$ inch from the roof, with patterns drawn on them as in Fig. 543. Little cardboard turrets (Fig. 542) are cut out and gummed in each corner, p and q (Fig. 534). Little cones of paper, made by rolling together a circle cut as in Fig. 544, may be glued to the tops of the domes.

The whole should be mounted on a platform made of a piece of stout cardboard, x y, about a foot square or a little larger, supported on match-boxes placed two together. A row of these across the middle will prevent the platform from sagging. Trees can be cut out as in Chapter XX, Figs. 431 and 436, to stand round the temple.

A **Pagoda**, or memorial tower, in the province of Quei Chow in China (Fig. 545). This is made of nine hexagonal prisms. The bottom one is 2 inches high, the sides being also two inches; the dimensions of the next are $\frac{1}{8}$ inch less, the next another $\frac{1}{8}$ inch less, and so on. The last prism has side $\frac{3}{4}$ inch, height $\frac{3}{4}$ inch. An ornament for the top can be filed from a cork or piece of round wood. The platforms project about $\frac{1}{4}$ inch beyond the

prisms ; the supports may be cardboard or pieces of thin wood. The prisms are fastened together as described in the case of the lighthouse (Chapter XIII). The whole should be painted to represent stones, and doors marked on as in Fig. 545.

Fig. 546 shows a Mosque in an oasis in the Sahara Desert. Here the dome, A, an india-rubber ball, is let into a circular hole in

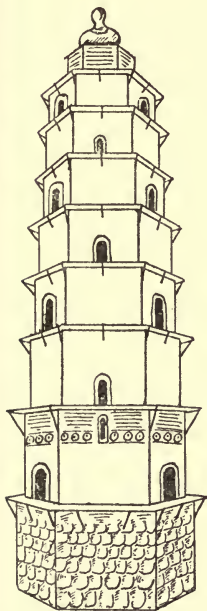

FIG. 545

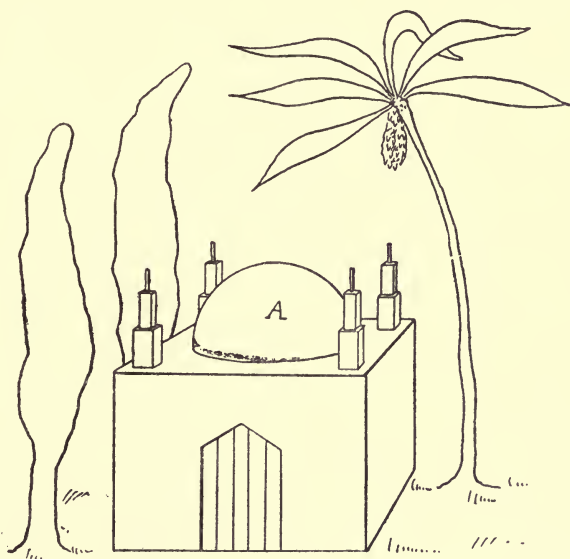

FIG. 546

the roof. The towers or minarets are prisms of cardboard on top of each other, surmounted by a piece of dowel rod, one end being rounded to a point. Trees can be cut out as in the figure to form a background.

Fig. 547 shows a Japanese Pagoda. This is built up in a similar manner to the Chinese pagoda. Parts A B C D are square prisms about 1 inch high ; E F G are truncated square prisms. They are made like the reservoir described in the models worked by sand (Chapter XXI), but the upper parts have been cut off ; they are glued to the squares of cardboard which rest upon the tops of A, B, C and D.

A piece of cardboard is glued over the top of E so that B can rest upon it, and so on with the others ; pieces of paper cut out as

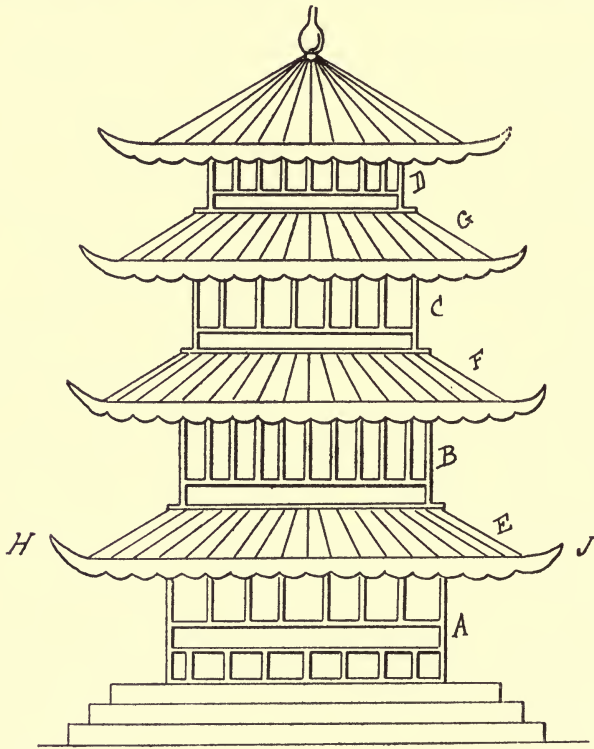

FIG. 547

at H J are gummed round the edges. There are many interesting models that can be made in this way. Almost any good illustrated geography book will provide plenty of material from which pretty and interesting foreign scenes can be built up.

CHAPTER XXVIII

A THEATRE

THIS is a toy that will provide hours of happy play.

There are many effective ways of making a toy theatre, and the planning and designing of one is a pleasant piece of work. This chapter gives a few suggestions to future theatre builders, who must adopt those that appeal most to them. A large stage is the most necessary part, so that there is plenty of room to set up the scenes and room for the actors. A small stage limits the choice of plays considerably.

A pretty and useful theatre can be made thus. Get a wooden box $8\frac{3}{4}$ inches wide, about 1 foot long and $2\frac{1}{4}$ inches deep. (The theatre described in this chapter was made from a wooden box containing Fry's Nut Milk Chocolate—this box is exactly the right size.) This box forms the basis of the platform; stand it bottom upward, nail to the back of it a piece of wood, $G H C D$, which is 1 foot square (see Fig. 548). The platform, $A B L M$, is a piece of stiff cardboard or wood, $A B$ is length of box, $L M$ is 2 feet. This makes a fine large platform for arranging scenes.

Pieces of stripwood $\frac{1}{4}$ inch by $\frac{1}{2}$ inch are glued across the platform, $A L B M$, each strip a little over a $\frac{1}{4}$ inch from the other (the $\frac{1}{4}$ inch side is glued to platform). About eleven strips can be thus glued across; their ends should project about $\frac{1}{4}$ inch beyond the platform.

The grooves thus formed are for running the actors up and down in.

A piece of wood, $a b c d$, is now cut 2 feet by $3\frac{1}{4}$ inches.

Holes are drilled along the top of it about $\frac{1}{4}$ inch in diameter, and red paper gummed at the back of them for the footlights. Panels or a pretty design of some kind should be painted on it, or it may have coloured paper pasted on it. This piece of wood is glued to $K J E F$ so that its ends project equally on each side.

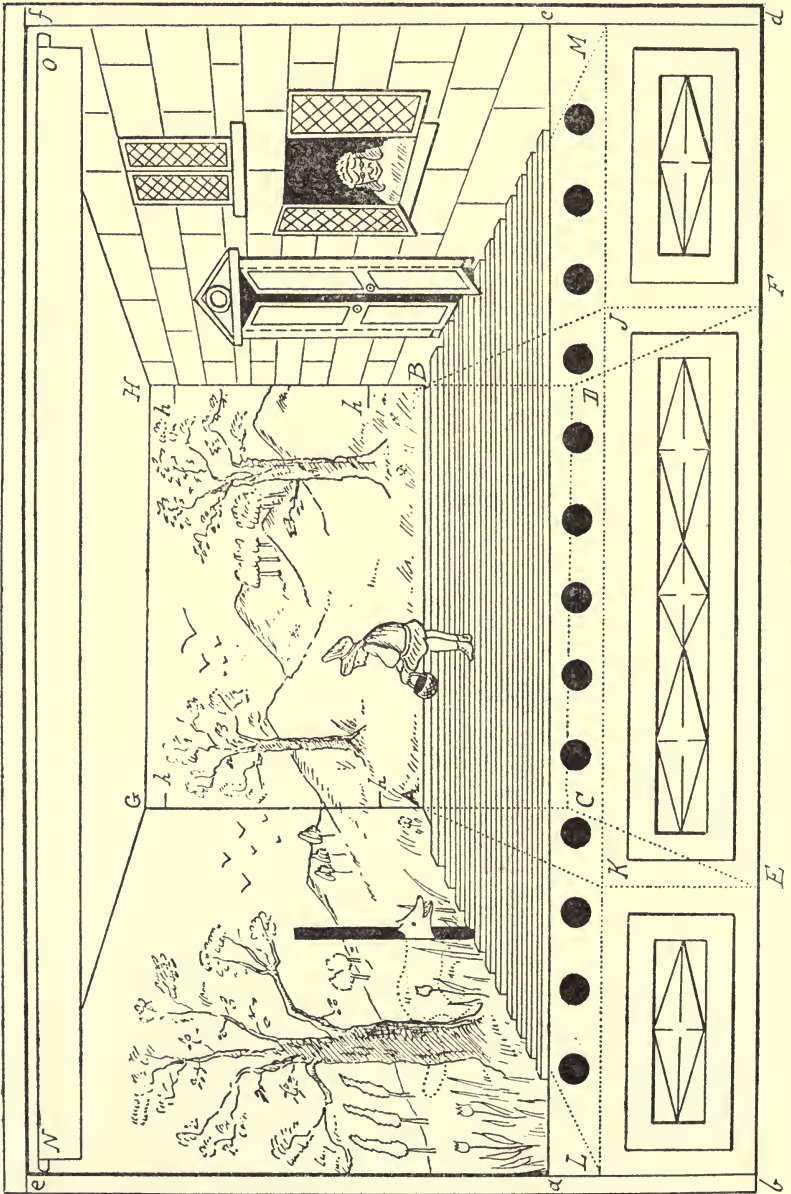

FIG. 548

Now cut two pieces of stripwood $\frac{1}{2}'' \times \frac{1}{4}'' \times 16\frac{1}{4}''$ (*eb* and *fd* in Fig. 548). Bevel the top ends to hold up cardboard roof *efGH* (the measurements for which can be easily found). The roof is secured by a flap glued behind *AGHB*, the roof is also glued to the tops of the strips *eb* and *fd*. These posts are glued to sides of *abcd*. Before they are glued on, however, they must have holes drilled near their upper ends for pole, *NO*, to pass through. The curtain must be made of fairly thin stuff glued to pole, *NO*. It can be pulled up and down by means of pulley wheels attached on each side. (For making pulley see Part I, Chapter XIV.) Pieces of lead can be sewn in the corners to make the curtain run down more easily.

Saw cuts are made across the strips of wood that cover the platform along lines *BM* and *AL*. Into these slits the side scenes fit. These side scenes are cut out of cardboard and have drawings and painting on them according to the story that is being acted. They must have slits cut in them (corresponding to the grooves in the platform), the number of slits depending on the number of actors. For example in Fig. 548 side scene *HfBM* has an open door through which Red Riding Hood can be pushed. She is cut out of either cardboard or wood, and glued to the end of a piece of stripwood, $\frac{1}{4}$ inch by $\frac{1}{4}$ inch, by means of which she is pushed from the side along the groove in the stage and so off through the corresponding slit in scene *GeLA*. (In Fig. 548 the Wolf is looking through this slot.) The window in scene *HfBM* can be made to open and show the Grandmother inside. The cardboard scene, *GHA B*, is kept in its place by pieces of wire (*h, h, h, h*) fastened at the back and bent over.

Almost any story can be acted in this theatre. All the actors are fastened to lengths of stripwood by means of which they are passed in and out. Sometimes two, three or more may be fastened to one length. The number of openings in the side scenes will, of course, depend on the story being acted.

Trees, etc., can also be cut out as described in Chapter XX (Part II), and stood about.

A sea scene looks very effective. Waves can be cut out of cardboard and placed in every groove, as in Fig. 549, and a ship drawn across. A shipwreck forms an exciting scene. Indeed, there is no end to the scenes—soldiers marching past, stories and

scenes from history and literature, etc., etc. The ingenious owner of the theatre will think of many, and add many improve-

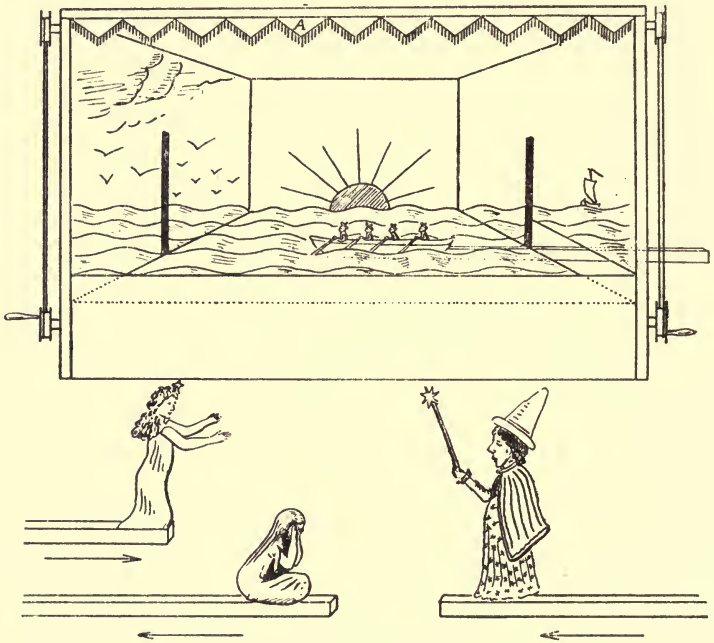

FIGS. 549 AND 550

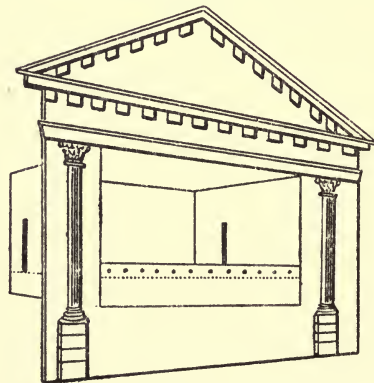

FIG. 551

ments. It must not be forgotten that the stage is large enough to hold small objects—trees, etc.—to make the scenes look more

realistic. Also holes or slits can be made in the roof if it is necessary to pull anything up or hang anything. Fig. 549 shows how a fringe of paper, A, can be fastened to the roof and bent over to hide the pole on which the curtain is wound.

Fig. 550 shows how the scenes are worked ; as the Witch is pushed on from one side, the weeping Cinderella is pushed off ; when she has quite gone and only the Witch remains, a radiant Cinderella comes on, followed by a coach, etc.

Lastly, Fig. 551 shows a proscenium, which may be built up of either cardboard or wood, and fixed to the front of the theatre. The sides should project sufficiently to hide the working of the strybs by means of which the actors are moved on the stage.

Here, for the present, we take leave of the reader, having given him or her some insight into a subject both pleasant and profitable. The preceding pages are no more than an introduction to the art of making toys, and of making the most of simple tools and simple materials, and their real purpose is to encourage our young people not only to copy but also to create, or at any rate to copy not only from our book but from the world around them.

Dolls' houses and furniture, railways, boats and other vehicles offer endless possibilities of original and attractive design, and mechanical toys, whether driven by wind, water, elastic or the works of an old clock, offer an equally wide field for invention. At a later age girls will no doubt be ambitious to devise useful articles for the home, while boys may become interested in engineering and electrical models, optical toys, etc. ; the deftness of hand, acquaintance with elementary principles, and self-confidence acquired through the simple work which we have described, should stand them in good stead.

Self-reliance and ingenuity are valuable assets with which to start upon the more serious tasks of life, and if our hints on toy-making contribute in any way to the development of these qualities this book will not have been written in vain.

c. k.

14 DAY USE
RETURN TO DESK FROM WHICH BORROWED
LOAN DEPT.

This book is due on the last date stamped below,
or on the date to which renewed. Renewals only:
Tel. No. 642-3405
Renewals may be made 4 days prior to date due.
Renewed books are subject to immediate recall.

UCLP (M)

JAN 7 1971

RETURNED TO

DEC 30 1970

LOAN DEPARTMENT

AUG 20 1978

DEC 1 1995

REC. CIR. AUG 18 '78

RECEIVED

DEC 02 1995

CIRCULATION DEPT.

LD21A-60m-8,'70
(N8837s10)476-A-32

General Library
University of California
Berkeley

YC 18250

U. C. BERKELEY LIBRARIES



0051413959



