

UC-NRLF



QB 31 867

DESIGN • AND
CONSTRUCTION
•• IN ••
WOOD

WILLIAM NOYES

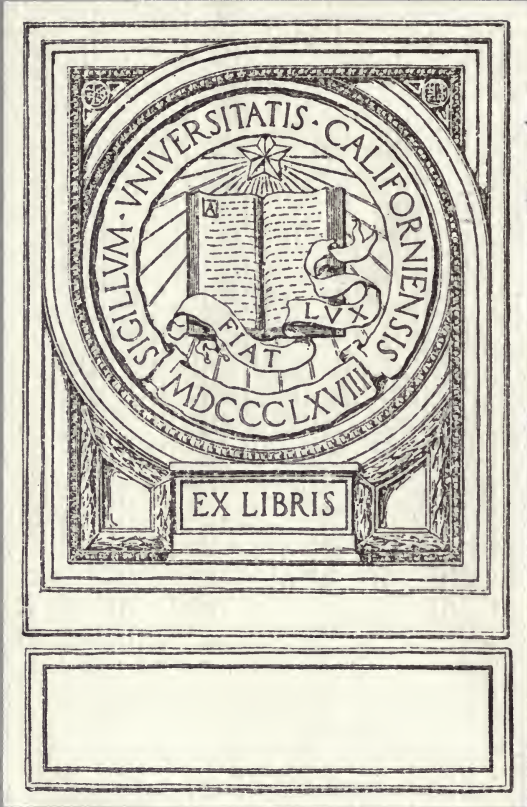

EX LIBRIS

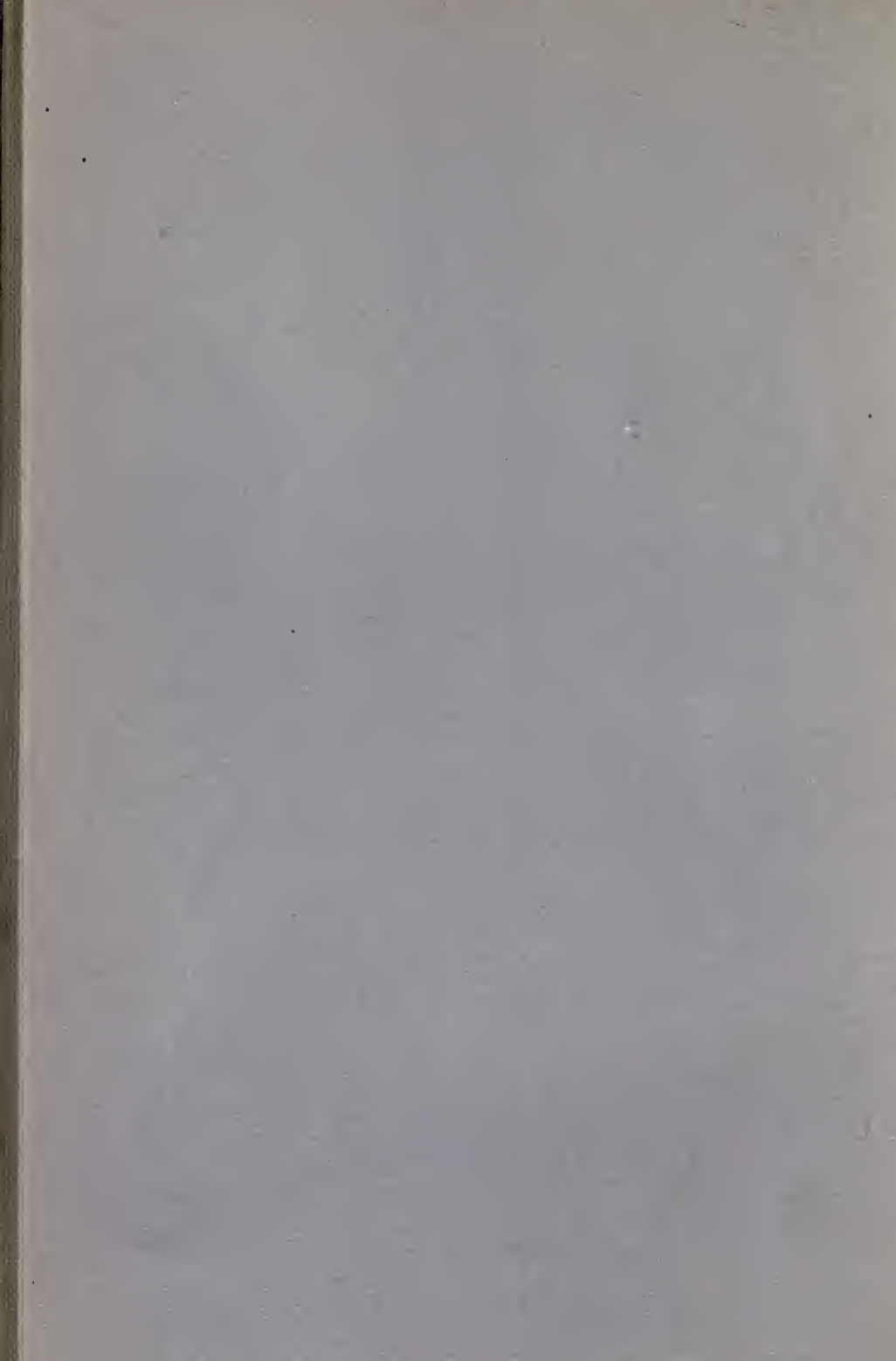

UNIVERSITY OF
CALIFORNIA

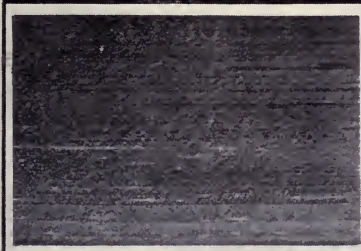

WHITE PINE

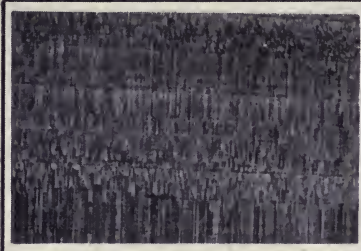

CYPRESS

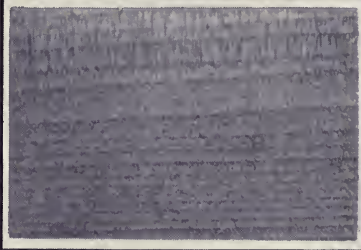

SPRUCE

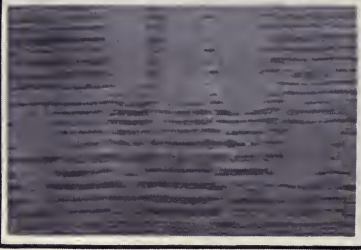

RADIAL WHITE OAK TANGENTIAL
COMMON WOODS

TO THE
LIBRARY OF
THE UNIVERSITY OF
MICHIGAN

BOOKS BY WILLIAM NOYES

Handwork in Wood

Wood and Forest

Design and Construction in Wood

DESIGN *and* CONSTRUCTION
IN WOOD

By WILLIAM NOYES
Assistant Professor of Industrial Arts
Teachers College, Columbia University
NEW YORK CITY



THE MANUAL ARTS PRESS
PEORIA, ILLINOIS

WILLIAM NOYES
FOURTH EDITION, 1919

TTT180
N7

COPYRIGHT
WILLIAM NOYES
1913

FOURTH EDITION, 1919

FOREWORD

The purpose of the following studies is, (I) to give to beginners in woodworking an opportunity for the acquisition of skill in the handling of tools, and, (II) some practice in designing simple projects in wood.

I. This series of projects is not offered as a hard and fast course. The training of the hand does not depend upon following a fixed order, like a course in geometry. Many roads lead to the goal. This course claims to be a practical one because, tho constantly changed, it has been a successful one. No greater misfortune could befall a course in handiwork than that it should be stereotyped. Indeed, my chief misgiving in publishing the course is lest it seem to have found final shape.

To obviate this impression, other projects involving the same or similar processes are suggested and illustrated.

It will be noted that the course here outlined is so planned that:

1. A variety of woods is employed, each appropriate for its particular project. They are: cypress, whitewood, maple, white pine, mahogany, chestnut, hickory, sweet gum, oak, and black walnut.

2. In general, the technical processes involved increase in difficulty thru the series, but esthetic considerations are not sacrificed to this formula.

3. Several types of construction are employed, involving such joints as: end-lap, rubbed, miter, middle cross-lap, doweled butt, and ledge.

4. A few simple processes in copper working are included because their employment considerably extends the range of useful and ornamental projects available.

5. A variety of finishes is suggested, including several methods of staining, as well as the use of such polishes as oil, wax, and shellac.

In a word, the course involves a considerable variety of experience in technical processes.

The attempt is here made to reduce the practice of the shop to words and pictures, in order that it may be available to those who must work alone. The author, however, does not at all presume to believe that, however helpful books may be to the worker, they can ever fill the place of individual instruction and demonstration.

II. In this series all but two of the projects, the picture-frame-clamp and the mallet, are such as to invite the worker to create his own designs. To this end a considerable number of suggestive illustrations are introduced. Design may begin with pure imitation, but it never ends there. It is my hope, therefore, that as the student worker proceeds thru the series, he will more and more freely design good things. Some general suggestions for help in designing will be found in Chapter II, and these are supplemented in each succeeding chapter by concrete application of the general principles to the project in hand.

CONTENTS

CHAPTER	PAGE
I. Wood	13
II. Wood, A Medium of Artistic Expression.....	21
III. Equipment	29
IV. A Scrap-Basket	35
V. Picture-Frame-Clamp	59
VI. The Mitered Picture-Frame	65
VII. The Candlestick	83
VIII. Taboret	99
IX. Mallet	115
X. Trays	123
XI. Rolling Blotter-Holder	133
XII. Small Boxes	137
XIII. Lanterns	147
Index	158

CHAPTER I

WOOD

Next to food and clothing, wood is to man the most useful of substances, and there is no other single substance that has as great a variety of human uses. The prosperity of any nation is largely measured by its timber supply, and hence we see the extraordinary efforts now being made by progressive nations to conserve their forests. Today the lumber industry is the fourth largest industry in the United States, and any intelligent person can quickly make a list of scores of uses to which wood is put. Two-thirds of the people of the United States live in wooden houses and half of the population burn wood as fuel.

One of the most useful qualities of wood, namely its combustibility for fuel, also constitutes one of its most serious disadvantages; it is not fireproof. On the other hand, until it is actually burned thru, it retains its stiffness, a fact that is not true of hot steel. It is because of its destructibility by fire, as well as by insects and decay, that attempts are constantly made to find substitutes for it. But even in spite of the employment of such substitutes as cement and steel in constructive work, its use is constantly increasing.

Most of our paper is made of wood and practically all our furniture. Its great utility depends upon such qualities as its size, its strength, its lightness, its ease of working, its elasticity, its hardness and its beauty. When wood is to be used for building or other constructive work, then its size is of great importance, while in work requiring only small pieces, other qualities, such as hardness, or permanence of shape, are determining factors. The strength of wood is shown by the fact that a hickory bar will stand more pull than a wrought iron bar of equal length and weight, and a block of long-leaf pine will stand nearly as much crushing weight as a block of cast iron of equal height and weight. Hickory is so tough that no substitutes for it in wheel-spokes, handles and similar articles which have to stand constant blows, have as yet been found. The hardness

and elasticity of such woods as oak and maple make them suitable for floors. Some wood, like spruce, that is both light and strong, is used for ladders and poles and canoe paddles.

For ease of working and permanence of shape, no wood compares with white pine, "the King of Woods," but unfortunately this species is now becoming scarce. For the making of furniture, two woods now hold supremacy, oak and mahogany. This is due partly to their beauty, but also to their strength. The oak is native; the mahogany is imported.

One of the most useful characteristics of wood is its ease of being joined together by nails, screws, glue, etc. Woods differ greatly in this respect, white pine, yellow poplar, and bass being very easy to nail, while oak, hickory, maple, and ash are difficult to nail without splitting. In general, the tough elastic woods split badly in nailing, while the soft brittle woods nail well. Hence, with some woods, before nailing, special precautions, like boring holes, have to be taken. On the other hand, woods like oak and maple, which are difficult to nail can be very securely joined together by means of screws. Certain woods, notable among which are mahogany and white pine, can be glued together with remarkable tenacity. This susceptibility to the cohesive action of glue is a most useful characteristic of all our common woods. Soft woods glue much better than hard woods.

One quality, possessed by all wood, is of serious disadvantage, namely its sensitiveness to moisture. It shrinks when dry and swells when wet. This necessitates particular care in certain forms of construction and in methods of finishing. The shrinkage of wood is to be explained by its internal structure. Wood is composed of "cells" or fibers, which are long, slender tubes, thru which, during the life of the tree, the sap passes. The cells formed during the spring of each year grow large with thin walls, and those formed in the summer grow smaller with thick walls. A layer of spring wood and of summer wood together form an "annual ring" as seen in a cross-section of a log, or stripes, as seen in a longitudinal section. Running across these up-and-down cells and radiating out from the center of the tree are other cells called "pith rays," sometimes very large, as the "silver flakes" in oak (see frontispiece), sometimes very minute—as in pine. They serve to bind the annual rings together and often, as in beech, sycamore and oak, add great

beauty to the grain of the wood. Now wood shrinks because the walls of the cells which compose it become thinner as they dry. For some unknown reason wood cells do not become shorter, so that wood shrinks very little in length. This peculiarity is made use of in constructing doors and in other panel constructions.

Wood shrinks most circumferentially, that is, in the direction of the annual rings, and somewhat, radially. This explains why boards often warp as they do, that is, in the direction opposite to that of the annual rings in them (Fig. 1). A board is said to be "warped" when one side shrinks more than the other. This warping is sometimes due to the fact that one side is drier than the other. In such a case the board can often be straightened by drying the other (convex) side.



Fig. 1. Boards usually warp in the direction opposite to that of the usual rings in them.

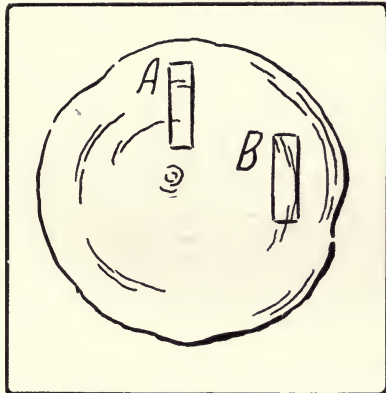

Fig. 2 A, Comb grain board; B, Slash grain board.

But usually the warping is due to the direction of the annual rings in it. A "comb grain" or "rift" board, Fig. 2, which is cut radially in the log, is less likely to warp than a "slash grain" or "bastard" board which is cut from the side of the log.

nearly radially as is consistent with economy. In some woods, as in oak and sycamore, the beauty of the grain caused by the exposure thus made of the pith rays, is an additional reason for quarter sawing. See frontispiece.

It is partly for this reason that much fine lumber is "quarter sawed," Fig. 3. That is, radial boards are sawn out first, dividing the log into quarters which are then sawed up as

Disadvantageous as the shrinking and swelling of wood is for most purposes, it is sometimes made use of, as in splitting soft stone by means of wetting wedges which have been driven into borings in the stone.

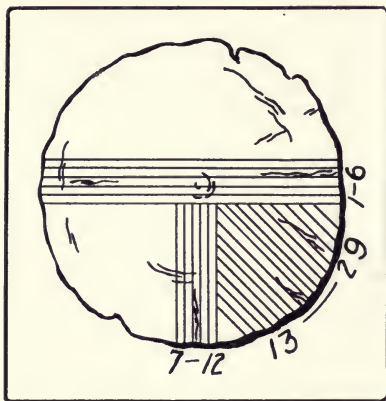

Fig. 3. Common method of quartering log.

piece), or to the peculiar changing reflection of light due to cross grain as in mahogany. The terms coarse grain and fine grain may refer respectively either to the width of the annual rings or to the presence or absence of pores¹.

Wood is sold by the *board foot*; that is, the unit of measurement is a board, one inch thick, one foot long, and one foot wide, or 144 cubic inches, Fig. 4. A simple method of measuring is to multiply the length in feet by the width and thickness in inches and divide by 12. For example 1" (thick) \times 8" (wide) \times 10' 0" (long) \div 12 = 6' 8" B.M. (board measure). Boards less than one inch thick are calculated as one inch. Dressed lumber, that is, planed on both sides, comes $\frac{3}{16}$ " less in thickness than sawn lumber. For example, boards sawn 1" thick are planed to $\frac{13}{16}$ ". For all ordin-

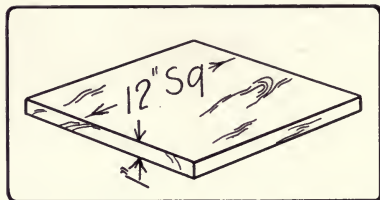

Fig. 4. A board foot.

¹A fuller discussion of this subject will be found in the author's *Wood and Forest*, Chapter I. The Manual Arts Press, Peoria, Ill.

ary purposes it is economical to buy 13/16" stuff. For thinner boards one may have this resawn at the mill.²

Following are descriptions of a few common varieties of wood.

As an aid to their recognition, see the illustrations, frontispiece.

White pine has been the most useful of all trees in the United States. The wood is one of the easiest and most satisfactory to work, owing to its uniformity of grain. For all purposes that require a wood that shrinks and checks but little and holds its shape well, such as molding patterns, window sashes, cores of doors and cabinet work, white pine is unrivaled. It is very light and soft, and is of medium strength, elasticity, and durability. It splits easily but nails well. In color it is light brown, almost cream color. The grain is not noticeable and has no particular beauty. Hence when used for house trim it is usually painted. Its former abundance made it cheap and it has therefore been used so recklessly that now it is becoming scarce. Red pine is often sold with and for white pine. Price in N. Y. C., 1913, \$120 per M (thousand).

Cypress is a soft, easily worked wood, that does not warp badly but is likely to contain many fine checks. It nails well and is very durable. Hence it is much used for shingles, posts, railway ties, and conservatory construction. As seen in slash grain boards, it is often beautifully figured by the fine lines of summer wood between the broader spaces of spring wood. It has a reddish brown color and no resin ducts. Its beauty makes it a desirable wood for interior finish and for many pieces of furniture. Price in N. Y. C., 1913, per M. \$65.

Spruce is a straight grained, strong, light, elastic, and rather soft wood, which shrinks and warps but little, is easy to plane and saw, but hard to chisel neatly across the grain because the spring wood is so much softer than the summer wood that it crushes before it cuts. It nails fairly well. It is used chiefly for construction, for ladders, for paddles, and other articles requiring both strength and lightness and, preferably, for paper pulp. It is the wood from which sounding boards are made because it is very resonant. It can be substituted for many uses of pine. The color is dull white, and the rings not noticeable. Very strong, light, furniture can be made of it. Price, in N. Y. C., 1913, \$50 per M.

²Further information about measuring lumber can be found in the author's *Handwork in Wood*, pp. 48 and 109. The Manual Arts Press, Peoria, Ill.

White oak is now the wood most commonly used for interior finish and furniture. It is very strong, quite heavy and elastic, and hard. It is rather hard to work and to nail, and checks and warps considerably, unless carefully seasoned; but when once worked up is without a rival on account of its strength and beauty. The color is a light brown. The rings are plainly defined by pores, which make a pleasing pattern in slash sawn boards. Its great distinction lies in the pith rays, which are broad, conspicuous, and irregular. They are often an inch or more wide and many inches long. These rays are very hard, almost like horn. They are brought to plainest view in radial (or rift) boards, and hence quarter sawing, tho un-economical, is commonly practiced to obtain the most effective "grain." As the wood is becoming more scarce, inferior species are mixed in, smaller trees are cut, and radial veneers are more and more used. In staining, the pores absorb much more color than the summer wood or the pith rays, and hence, no wood is capable of such contrasts of grain when stained as oak. Price in N. Y. C., 1913, \$135 per M.

White ash is a heavy, strong, elastic, hard wood, used especially for handles of farm tools, oars, barrels, etc. It splits badly in nailing. It is used considerably for inside finish and furniture both on account of its strength and the beauty of its figure when slash sawn. The "grain" is due to the massing of the pores in the spring wood. It is the hardest and best of the ashes. Black or brown ash is much easier to work, and is sufficiently strong for most furniture. Price, in N.Y.C., 1913, \$85 per M.

Yellow poplar or white wood grows with a tall straight trunk unsurpassed in grandeur by any other eastern American tree. This furnishes clear knotless boards, often 15" to 18" broad. It is a general utility wood, largely taking the place once held by white pine, and is used for cheap furniture, interior trim, and carriage bodies. It is light, brittle, soft, easy to work, nails very well, has medium strength, and does not warp badly when properly handled. The pith rays are quite noticeable, but are not made much use of for decorative purposes. The rings are distinct but not prominent, and the color is greenish or yellow brown. It is a good wood to keep in stock for all sorts of purposes, and an ideal wood to carve. In the south, magnolia is often sold with and for yellow poplar. They belong to the same family. Price in N. Y. C., 1913, \$80 per M.

Sweet gum. Except for one quality, sweet gum would be one of the most useful woods. It has an even texture, is comparatively easy to work, takes a beautiful finish and polishes well, is an ideal wood for carving, and with a little care can be nailed well. It has a beautiful chocolate hue varied by uneven deposits of coloring matter. But it twists and warps more than any other common wood, and hence

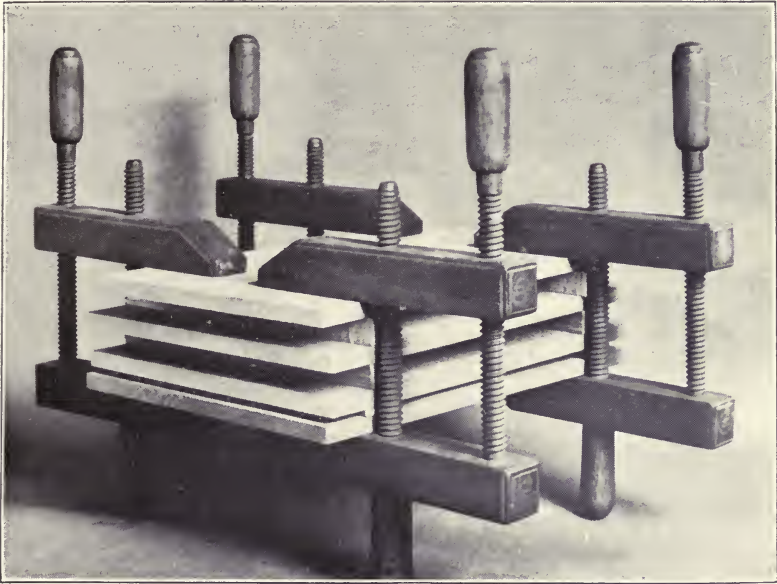

Fig. 5. Clamping up boards to keep them from warping.

for commercial purposes is largely used in veneers. For small articles of household use, it is an excellent wood. Price in N. Y. C., 1913, \$75 per M.

Mahogany is a general name covering a number of species, all of which are imported. The chief varieties are Central American mahogany, African mahogany, Mexican mahogany, East Indian mahogany (vermillion wood or padouk), and Spanish cedar. These varieties are somewhat alike in color, a reddish brown, the annual rings are inconspicuous, the pores are scattered, and few woods take glue better. They vary considerably in hardness, in difficulty of nailing, and in shade of color. The common uses are furniture and interior

finish. The grain is very likely to be variable, causing a very pleasing, changeable, reflection of light. Price in N.Y.C., 1913, \$185 per M.

In the following studies, the woods just described will be recommended.

It is impossible to give explicit directions for laying in a supply of wood. Some varieties of wood may be plentiful in certain places, others may be scarce and hence expensive. Some workers may be able to obtain the wood in nearly the sizes wanted; others may be compelled to purchase whole boards. Some may have a dry storage room of ample size, as, for instance, an attic; others may be compelled to store their lumber in a damp cellar. In general it may be said that one should buy only what he can take good care of. Where any quantity of lumber is stored, it should, if possible, be "stacked," that is, piled flat, each board separated from its neighbors by small cross sticks to allow free circulation of air. If possible, there should be a weight on the top board. Where only a few boards are to be put under pressure, it is often convenient to clamp them together with handscrews, as in Fig. 5.

BIBLIOGRAPHY

Filibert Roth. *Timber*. Bulletin No. 10, of the Forestry Service, Washington, D. C. (May be secured from the Supt. of Documents, Washington, D. C., for 10c.) A brief, accurate, and non-technical but comprehensive study of the structure and properties of woods, with a description of common varieties and a key to their study.

Katherine Golden Bitting. *Woodcraft*, June-Sept. '06.

William Noyes. *Wood and Forest*. Manual Arts Press, Peoria, Il.

CHAPTER II

WOOD A MEDIUM OF ARTISTIC EXPRESSION

Projects in wood that admit of artistic variation are subject to the same fundamental principles of design that underly all the space arts. The constant problem of the artistic woodworker is to familiarize himself with these principles. One way of doing this is the keen observation of their application by past and present masters in wood. Familiarity with the masterpieces of woodwork in other ages and lands will give additional zest and interest to the application of these principles. For instance, the hand workers in wood of Italy, Spain, France, England, Scandinavia, and Japan, have much to teach us in line, proportion, and construction.

The other way of learning these principles of the space arts is by repeated application of them in constructive work. Only in the latter way does the worker come to realize the limitations of his own medium. The production of beautiful objects acquires a much more lively interest when good taste and the ability to design are developed along with manipulative skill in execution. On the other hand, the acquisition of skill becomes of vastly greater importance if it is used as a means of creating things of beauty.

In a word, artistic judgment and skill of hand develop best when they develop together. Each justifies and ennobles the other.

In the making of the following projects, where ample opportunity is given both to design and to construction, the meaning of beauty as related to wooden structures should grow clearer as the articles suggested are worked out. Experience here, as elsewhere, is the best teacher.

It is not to be inferred, however, that one can safely hope to improve thru self-criticism alone. The dangers of going off at a tangent are too great. In design, even more than in construction, the critical assistance of a competent teacher is invaluable. The constant appeal for help to superior artistic judgment is the surest path to good taste.

The underlying principles of the visual arts have been clearly stated, tho not in identical terms, by several writers, and as the principles herein suggested for the woodworker are based upon the broader principles common to all space arts, the reader is strongly urged to familiarize himself with them. They are well analyzed and illustrated in the following books:

Arthur W. Dow: *Composition.*

Denman W. Ross: *Theory of Pure Design.*

Ernest A. Batchelder: *Design in Theory and Practice.*

George Lansing Raymond: *Proportion and Harmony of Line and Color.*

Lewis F. Day: *The Application of Ornament.*

The properties of the particular medium thru which art is expressed present to the artist certain limitations which he must recognize. This in no way suppresses creative expression, but rather disciplines it.

The following, then, are the possibilities and the limitations within which the woodworker may revel:

1. In the first place, the thing to be made should in itself appeal to the craftsman as something worth while and interesting to make. For instance, scrap-baskets, picture-frames, desk-trays, hanging lanterns, and such familiar objects as are frequently seen or handled, should call forth the worker's best effort.

2. The article to be made should be so designed and constructed as to be structurally sound. Nothing is completely beautiful which is poorly constructed. The joints of a frame should not open with varying temperature and humidity. A chair should be so constructed as to hold the weight and strain ordinarily expected of chairs, for an indefinite time, or as long as the wood lasts. A hundred years is not too long to expect a chair to be of service. Many last longer.

3. The form of the article should frankly indicate the material; wood should not be made to look like metal or stone. Appropriateness of shape to material should be so obvious that there would be no mistaking a wooden candlestick for one of pottery or brass.

4. The structure of the article should be recognized or even emphasized, but not contradicted. In wooden structures this principle has to do primarily with the matter of joints. Joints may in many cases be made obvious, as in the decorative use of fastenings,

so that there is no mistaking the form of construction. In cases where the joint is concealed, the principle stated would demand that there be no pretense of a form of construction that does not exist, as, for example, when a false keyed mortise-and-tenon joint is stuck on where the pieces are actually doweled together. In a word, the construction should be honest, and if it is obviously honest, it may be all the better.

5. The article should also be convenient for use. The socket of a candle stick should be of the proper size to hold ordinary candles. A pen-tray should be long enough to hold pens and pencils and should not be easily upset. A chair seat should be the right distance from the floor, and the rail in front should be high enough to allow the sitter to slip his feet under it and so rise easily. The requirements of convenience set limitations to design. Proportions must conform to intended use.

6. Lastly, when an interesting object has been chosen, when proper materials and sound construction have been determined upon, when it has been planned for convenience in use, so that the size and shape are approximately fixed, then the sense of beauty plays, as it were, with these possibilities, feeling for the most satisfying proportion of parts to whole and parts to each other, trying one arrangement after another, studying how to secure a rhythmic repetition of the same motive, how to break up an outline or a surface harmoniously into principal and subordinate parts, and how to keep it as a unit well balanced.

In analyzing more particularly what it is with which the craftsman plays in creating beauty in these little wooden structures, four considerations are of prime importance: (1) mass, (2) line, involving light and shadow, (3) color, (4) finish.

1. *Mass*. The first consideration is the appearance of the object as a whole. It is to be thought of as a silhouette, as an object standing between the observer and the light, so that the general proportions are obvious; that is, the relation of width to height, of part to whole, and of part to part, including a consideration of vacant spaces as well as occupied spaces, should be clearly defined. Seen or imagined from this point of view, the details are lost, no lights or shadows are conspicuous, but only the general mass. It must have the beauty that one sees when the trees, rocks, and hills are silhouetted

in a pattern of pleasing proportions against a twilight sky. In other words, the first and fundamental esthetic test and requisite is that the proportions as a whole should be pleasing.

The basket, candlestick, lantern, and so on, which in the following pages are suggested for making, are studied from this point of view; they are planned to keep the height and width and depth in pleasing relation each to each, and to so proportion open with closed spaces as to secure an artistic arrangement of parts. In other words, the composition made by placing the object against a lighter or darker surface should be pleasing in dark and light.

2. *Line.* When these general masses and spaces are approximately determined, the next step is to fix the character of their boundaries. The outlines are to be refined and embellished, and here we may have all the variety that lies between that severity of line found in the earlier European furniture—whether Scandinavian, Italian, Spanish or English, and the elaborateness of carved and turned and fluted styles, such as is characteristic of the later Elizabethan or Gothic furniture. How simple or how intricate, how bold or how delicate the lines shall be, depends partly upon the nature of the material, partly upon the skill and the judgment and the taste of the craftsman, and partly upon the use to be made of the object.

The nature of the line affects directly the high lights and shadows that appear when the object is well lighted. Good lines will produce interesting notes of light and dark. They will “catch the light” and “throw shadows” at pleasing rhythmic intervals, making interesting patterns in “notan”³. This is the merit of artistic moldings, turned work, carving, and inlay, that they make possible intricate and diversified compositions of dark and light (and in the case of inlay, of color), that are impossible in severe, plain styles. On the other hand, the attractiveness of plain forms lies in their very simplicity. Moreover, as the plainer early European or Japanese styles involve fewer elements to be spaced, the chances for the beginner to get better designs in them is greater than in the more elaborate styles. So, until considerable mastery in handling space relations in wooden structures is gained, the beginner is advised to work in the spirit of these plainer, simpler styles.

³Notan—a Japanese term meaning dark-and-light.

3. *Color.* Thirdly, there is the consideration of color. The natural hues of the woods give a considerable variety, ranging from the light yellow brown of oak, chestnut, and ash, to the reds of mahogany and the purples of walnut and sweet gum. All of these can be greatly modified artificially by stains or by chemical processes. (See the author's *Handwork in Wood*, pp. 209-214.)

The problems in color, both in hue and value, is that of harmony with surroundings. No piece of furniture, however small, should be considered as a thing by itself. It is to be treated as one element that will enter into the composition of a beautiful room, and upon its harmony therewith will depend its own beauty.

As regards the color of furniture, it may be said in general that the esthetic tendency is away from yellow tones. These are all the harder to avoid on account of the yellowness of the common finishes, varnish and shellac. The best that can be done by amateurs is to gray the yellow by fuming or staining. On the other hand, a frank yellow tone may be appropriate and effective, as, for instance in a blue setting.

4. *Finish.* The fourth element of beauty in wood is finish. The simplest and oldest process is rubbing with or without oil or wax, which only emphasizes the quality of wood as wood. The more modern finishes, varnish and shellac, succeed in "bringing out the grain," but at the expense of making a surface that looks, not like wood, but like glass. Unlike glass, however, varnish is easily marred. To keep the shining surface perfect, demands constant protection and care, and suggests that such pieces are made, not to use, but to look at.

It may frequently happen that in order to secure a desired effect of mass or line or color, the design or construction originally adopted may have to be reconsidered and something else substituted that will give a satisfying harmony. Each feature is thus to be decided tentatively, subject to such modifications as other features may demand in securing unity of design for the structure when complete.

Altho the steps mentioned seem to give the logical procedure in building all sorts of things, whether foot-stools, chairs, or thrones, trussed, arched, or suspension bridges, dog-kennels, cottages, or castles, yet a little reflection and observation will show that one or another of these steps has frequently been omitted. The library of one of our famous universities is a good illustration of a beautiful

building poorly planned for its use. Utility is sacrificed to good proportion. On the other hand, the so-called typewriter chair is a model of convenience and comfort, but it will never find a place in a museum as a thing of beauty. Utility has not yet been cast in pleasing line and tone.

The following, then, is suggested as a logical method of procedure in designing simple wooden structures. In actual experience it is not necessary to decide these points in this order, or in any order, but in general these are the items that should receive deliberate consideration at some time between the conception and completion of an artistic structure.

I. *The fixing of essentials*, or of those points that make for an article's convenience in use. Under this head, such matters as the following are determined:

- a. The approximate or definite size.
- b. The kind of wood to be used. Each has a quality that makes its characteristic appeal for certain constructions. See Chapter I, also Chapter III, *Wood and Forest*.
- c. The construction, including:
 - (1) Kind of joint or joints.
 - (2) Methods of opening and shutting or locking.
 - (3) Appliances for lifting or moving or hanging, and so on.

II *The refining of proportions*.

- a. Of the mass as a whole.
- b. Of each part to the whole.
- c. Of each part to each other part.
- d. Of each line within itself, if it curves or is a broken line, or is turned on a lathe.

III. *Decoration*. This relates to the decorative treatment of the surface.

- a. Carving, border or surface (all-over) patterns in gouged lines or modeled.
- b. Panels, carved in, or constructed in.
- c. Inlay or veneer.
- d. Designing of accessories—handles, knobs, key plates, escutcheons, etc.

IV. *Finish.*

- a. Stain.
- b. Paint.
- c. Oil.
- d. Wax.
- e. Shellac, including French polish.
- f. Varnish.

In general, the order in designing suggested above has been followed thruout the making of the following articles. The illustrations used are largely photographs or sketches of articles designed and executed by my students.

However, the possibilities for original design that lie within the range of these few objects of household use still invite the designer. There is here no intention of a cut and dried series of models, but rather such a presentation of what some of the possibilities of these projects are, that others to whom wood appeals as a medium of artistic expression will be stimulated to create still more varied and beautiful objects for our common every-day life. Or, feeling not too sure of his ability to create, the beginner may choose from the following suggestions the ones he likes best, in itself an exercise of artistic judgment, and copy them. And so, little by little in the effort to re-create others' designs that are known to be good, he may come to create good designs of his own. Or, at the very least, which is also much, thru this thoughtful copying of good things, he will be helped in his desire to appreciate beauty in wooden structures.

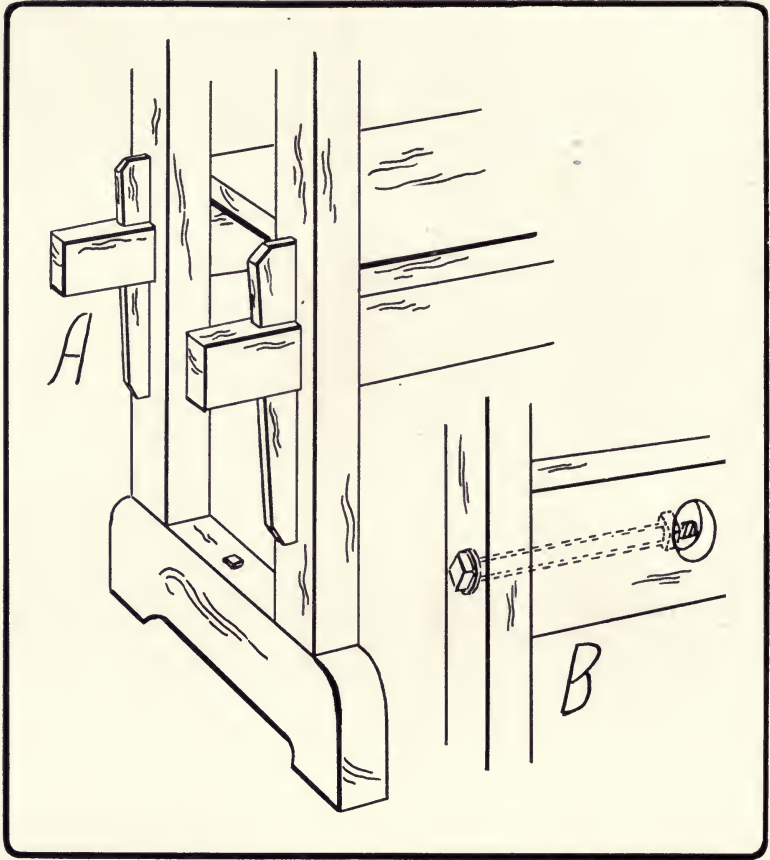

Fig. 6. *A*, Mortise and-tenon construction in frame of bench;
B, Draw-bolt construction.

CHAPTER III

EQUIPMENT

The equipment necessary for beginning to work in wood may be very inexpensive, costing not more than \$25. It is better to begin with a few good tools, well chosen, adding to the number others as they are needed. The total cost of a first class equipment need not exceed \$50.00.

It is rarely wise to buy the sets already made up in cabinets, for the lists given often include cheap and dispensable tools, and the quality is apt to be not the best. One can soon learn to make a cabinet to fit his own tools. It is wise to consult one's local hardware dealer before buying as well as those firms that have made a specialty of handling woodworking equipments for schools and amateurs. The latter have special facilities for furnishing the proper high grade tools. The names and addresses of reliable firms may be found in the advertising pages of any of the educational journals⁴.

The following tools are recommended for the individual equipment of a beginner⁵:

The bench. The essential features of a good bench are: (1) Rigidity. This may be secured in a bench made with either mortise-and-tenon-joints, Fig. 6,A, or draw-bolt construction, Fig. 6,B. The bench should be firmly fastened to the floor by lag-screws passing thru the two foot pieces.

(2.) A maple top with trough at the back.

(3) A low tool rack, that is, one not above the top of the bench, which does not obscure the light and is not in the way for large work.

(4). A good vise. The strongest, most durable, and most convenient are the rapid-acting vises, with the working parts of metal, which require an occasional oiling.

⁴For descriptions and illustrations of tools see *Handwork in Wood*, Chapter II. Manual Arts Press, Peoria, Ill.

⁵For school equipment see *Handwork in Wood*, Chapter VI.

The jaws of the vise should be faced with maple. Sometimes there are two vises, a side vise and a tail vise. The latter is exceedingly convenient for certain kinds of work.

There are various benches and vises on the market. Among other good ones are those of the following firms:

E. H. Sheldon & Co., 182 Nims St., Muskegon, Mich.

The Denver model (1 rapid-acting vise), price.....\$ 9.50

The Omaha model (2 rapid-acting vises), price..... 14.25

A. L. Bemis, Worcester, Mass.

Sloyd Bench No. 4, price 15.00

This has an iron vise, not quick acting, and a tail clamp.

Richards-Wilcox Mfg. Co., Aurora, Ill.

No. 260. 1, side vise only 12.00

No. 260. 2, side and tail vise 16.00

Hammacher, Schlemmer & Co., 4th Av. and 13th St., New York, N.Y.

No. L\$ 8.50

No. J 12.50

No. K 20.00

These benches at this price are all equipped with a side and a tail vise, the last with a Toles rapid-acting vise. The rapid-acting vise adds about \$6.00 to the cost, and by special order they may be attached to any standard bench. Among the many rapid-acting vises on the market are the W. C. Toles, Irving Park, Chicago, Ill.; The Abernathy Vise & Tool Co., 233 W. 62d Place, Chicago, Ill.; The Herriman Co., 15 S. Canal St., Chicago, Ill.; the Richards-Wilcox Co., Aurora, Ill.

A very good arrangement is to have a rapid-acting side vise, and wood-screw tail vise.

In a word, the bench and vise may cost from \$8.00 to \$20.00.

The tools⁶:

1 Stanley jack-plane No. 5.....\$ 1.75

1 Stanley block-plane No. 65 1/280

1 Iron spokeshave, No. 5425

⁶This list is made up from Hammacher, Schlemmer & Co.'s catalog No. 355. For pictures of these tools consult any of the books mentioned in the bibliography.

1 Stanley "Bed Rock" smooth-plane, No. 603 ⁷	1.60
*1 Stanley rabbet-plane and filletster, No. 78 ⁸	1.10
1 Disston's Crosscut-saw, No. 9, 22" 10 points	1.15
1 Disston's Rip-saw, No. 9, 22", 8 points	1.15
1 Disston's back-saw, No. 4, 10"95
*1 Turning-saw in frame 14", 3/16" blade90
1 Buck Bros. firmer chisel, 1", handled and sharpened..	.35
1 Buck Bros. firmer chisel, 1/2", handled and sharpened..	.25
1 Buck Bros. firmer chisel, 1/4", handled and sharpened..	.20
1 Buck Bros. firmer chisel, 1/8", handled and sharpened..	.20
1 Hammond's adze-eye hammer, No. 3, 7 oz.45
*1 Round hickory mallet, No. 4.12
1 Hardened blade try-square, No. 5 1/2, 6"25
1 Beech marking-gage, No. 64 1/2, 8"20
1 Sloyd knife, No. 7, 2 1/2" blade30
or a good pocket knife.	
1 Medium hard lead pencil (No. 2)05
1 Boxwood rule, 2', 4-fold12
*1 Disston sliding T-bevel, No. 3, 6"25
*1 Pair Starrett's dividers, winged, No. 92, 8"75
1 Veneer scraper, No. 8070
2 Molding scrapers, No. 2 and No. 715
1 Half-round wood file, K and F, 8", handled20
1 Rat-tail wood file, K & F, 8", handled20
1 Slim taper triangular file, 6"10
1 Disston's Back-saw in frame 14", 3/16" blade90
*1 Outside-bevel gouge, Buck Bros., firmer, No. 8, handled and sharpened, 1"35
*1 inside-bevel gouge, regular sweep, No. 10, 3/4"45
*1 Addis carving tool, 3/16", No. 11, round maple handle	.38
1 Barber's ratchet brace, No. 33, 8" sweep	1.40
1 Miter-box, beech, 12" long, No. 0030
Better ones are Olmstead's Patent No. 3	1.25
*Miller's Falls Co. No. 15 1/2	4.50

⁷If desirable to reduce expense substitute No. 603 for both No. 5 and No. 65 1/2.

⁸The tools marked * are not essential for beginning work and may be purchased later.

Still larger ones are the Stanley No. 240, and the Langdon Acme, No. 68, which cost about \$9.00.

* 1 Set twist bits, (3/32", 4/32", 5/32", 6/32", 7/32")64
1 Set Russell Jennings auger-bits (4/16", 5/16", 6/16", 7/16", 8/16")	1.40
*1 Clark's expansive bit, 1/2" to 1 1/2"57
1 Rose countersink, No. 10, 5/8"25
*1 Screwdriver-bit, 1/2", round blade 4" long16
4 Bradawls, handled, 1", 1 1/4", 1 1/2"15
1 New Century screwdriver, 4"16
1 O. K. Nailset, 1/16"07
*2 Carpenter's steel bar clamps, 3'	3.20
*2 Aldrich's oiled handscrews, No. 16, 10"80
*1 Glue-pot50
1 Glue-brush, 1/2"15
1 Glass-cutter, No. 1027
1 Flat varnish brush, No. 54, 1 1/2", hard, rubber-bound, (for shellac)30
2 Cheap tin-bound brushes, EE, 1"10
*1 Pike Peerless junior tool-grinder	4.00
or 1 Robertson's concave tool-grinder (The Robertson Drill and Tool Co., Buffalo, N.Y.)	5.00
or 1 Niagara No. 10 Carborundum tool-grinder	10.00
or 1 Empire tool-grinder (The Empire Tool Co., Albany, N. Y.) ⁹	2.80
1 Carborundum oilstone, medium and coarse combined, in iron box	1.15
1 quire sandpaper, No. 0030
1 quire sandpaper, No. 130
Supplementary list of metalworking tools:	
1 hand-drill, No. 04	1.40
Drills, Morse's, No. 17, 1 each, Nos. 10, 15, 20, 25, 30, 35, 40, 45, 50, 55, 6071
1 Iron vise, Parker's No. 30, oval slide	1.15

⁹It is well to learn to grind one's own tools as early as possible, but the expense of the grinder may be saved if there is another available, in a neighboring shop.

1 Pair end cutting nippers, No. 154, 5".....	.88
1 Pair Compton's metal snips, No. 12, 2".....	.63
1 Pair flatnosed pliers, No. 1806½, 5".....	.58
1 Mill bastard file, 8", safe edge, handled.....	.15
1 Mill smooth file, 8", safe edge, handled15

Wood Stains. It is well to begin with some simple stain, already prepared. Among such on the market are:

Craftsman Stain, dark brown, No. 2, 1 quart for \$1.00, Syracuse, N. Y.

Devoe & Reynolds, Penetrating Oil Stain, 1 quart for 70c, 101 Fulton St., N.Y.

The Bridgeport Wood Finishing Co., Penetrating Oil Stain, 1 pint, 20c, 155 Fulton St.

Wax. The easiest finish to apply and repair is wax. A convenient prepared form is:

Bridgeport Wood Finishing Company's Old Dutch Finish, price, 25c a pint.

Supplies. Nails, screws, etc., are now commonly put up in convenient packages, and would better be purchased as needed. Explicit directions will be given in each lesson as to what to obtain. A box divided into compartments, or a set of boxes so divided, which may be stacked in a set of drawers, will add greatly to the convenience of handling nails and screws. Until this is provided they may be kept in their paper packages¹⁰.

Glue. "Star" glue (imported) is the strongest, but it sets quickly. Peter Cooper's White Glue is excellent, and comes in convenient form.

BIBLIOGRAPHY

William Noyes. *Handwork in Wood.* Manual Arts Press, Peoria, Ill. Price, \$2.00.

Hammacher, Schlemmer & Co., *Tools*, Catalogue No. 355, N. Y., 4th Ave. and 13th St.

Ira S. Griffith. *Essentials of Woodworking.* Manual Arts Press, Peoria, Ill. Price, \$1.00.

¹⁰For descriptions of the various common fastenings, see *Handwork in Wood.*



a Fig. 7. Six sided baskets. *b*



CHAPTER IV

A SCRAP-BASKET

In designing a scrap-basket, matters for early consideration are:

I. *The fixing of the essentials.*

a. Of these the size must be approximately determined at the beginning. For ordinary purposes a waste-basket should not be more than 18" or less than 14" high, depending—so far as looks go—upon the size of the desk beside which it is likely to stand. As to breadth, it may be properly between 7" and 10", depending on the height. The shape may be square, Fig. 9, the easiest construction; or six sided, Fig. 7; or eight sided; or square with the corners cut, Fig. 8.

b. The next point to decide is the kind of wood to be used. Pine is easier for a beginner to work, but it is more expensive than cypress or spruce. Cypress is softer than spruce and hence easier to work, and has a pleasing grain. On the other hand, spruce is stronger. Take it all in all, cypress answers more requirements. The more expensive and harder cabinet woods, oak and mahogany, are all right for the experienced worker.

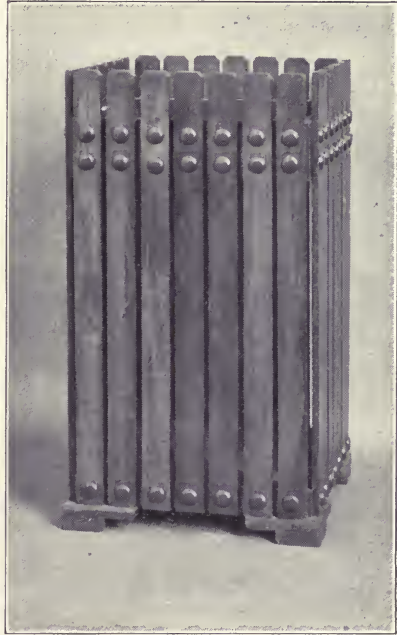

Fig. 9. Scrap-basket.

c. As to the *construction*, the simplest is the best; the slats are nailed to the flat bottom and to a frame consisting of a band of cleats at or near the top. If the cleat is made as in Fig. 9 this band or

rail may be boxed together very strongly with an end-lap joint as described below. If the rail is outside the slats, a miter joint should be used for appearance sake, Fig. 10. If the top is finished with a nosing, as in Figs. 10 and 17, the frame will serve as a ready means of lifting the basket. On the other hand, if the basket is finished

with the frame inside it is more conveniently lifted if handles of wood or copper or leather are added on two opposite sides. See Figs. 8 and 11.

II. *Proportions.* With these essentials fixed, we pass to the refining of the proportions.

The proportion of width to height should be subtle, not obvious, as 1 to 2 or 2 to 3. The width may be increased by changing the number of the slats or the spaces between them. To vary the width of the slats themselves increases the difficulty of planing which, for a beginner, is better kept easy. Various arrangements of slats are shown in the illustrations.



Fig. 10. Basket with mitered frames at top and bottom.

A variety of designs is possible by changing the position and width of the frame. By putting it at the very top of the slats with a mitered nosing over both slats and cleats, a neat substantial finish is obtained. Fig. 13. If the frame is lowered, some of the slats may be cut to different lengths and so shaped as to make a pleasing outline at top and bottom. Fig. 19. By the same method a handle may be introduced, Fig. 15.

III. *Decoration.* Several features may be added for decorative purposes as, for example, feet at the corners, perhaps with a little line carving, Fig. 9; lacing, instead of nailing at the corners, Fig. 7; not to speak of the handles already mentioned. For those who have facilities for working in copper, well designed handles and corner braces give an added charm to the appearance of the basket.

The use of upholstery nails, or large copper tacks (12 oz.), with the heads hammered into knobs or filed square, gives an artistic touch. See Figs. 7, 8, 11, 12, 13, 18.

IV. *The Finish.* The stain chosen should make the basket harmonize with its surroundings. Soft browns and grays are the safest. Dull red or gray-green may be suitable. Finally the basket may be waxed or oiled as described below.

The following directions describe the making of the basket shown in Fig. 9.

The scrap basket is chosen for the first project because it involves much sawing and planing, both of which processes it is essential to master at the outset. Moreover the planing is chiefly narrow-surface planing, which is easier for the beginner than broad-surface planing. Furthermore, when the project is successfully completed, it is worth having. The following materials are required:

Spruce, cypress, or yellow poplar

2 pieces, $\frac{7}{8}$ "x8"x16" } or 1 board, $\frac{7}{8}$ "x8"x4'0"

1 piece, $\frac{7}{8}$ "x8"x8"

1 piece heavy tin, 2"x2½"

1 pkg. wire brads, $\frac{7}{8}$ ", No. 18

16 flathead wire nails, $\frac{5}{8}$ ", No. 18.

8 doz. metalene upholstery nails, brown or green. No. 220
or copper tacks, 12 oz.

1 small can penetrating oil stain, brown or green

1 tin prepared wax

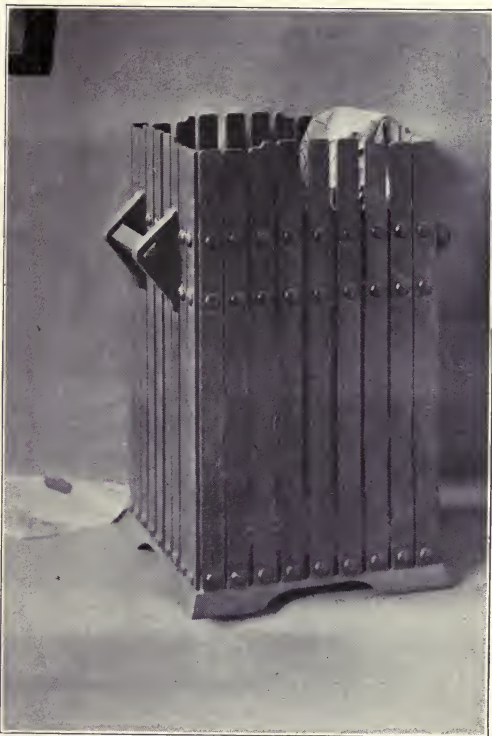

Fig. 11. A handle well designed for use and beauty.

I. *Getting out material.* For this first project select a piece of wood that is free from knots, and smoothly planed on both sides.

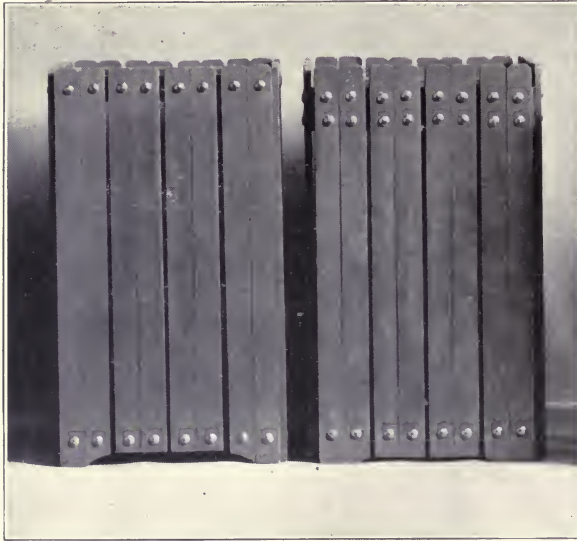

Fig. 12. Slats and nail heads arranged in rhythmic order.



Fig. 13. Basket with ends of slats covered with mitered nosing.

The first step is to get 2 pieces, 16" long and 8" wide. If you can get them exactly 16" long at a mill, do so; experience in making lengths will come better later after some practice in handling tools. If you must get out the proper lengths yourself, buy one board 4' 0" long, and proceed as

follows: Select the straightest edge of the board, and with the help of the try-square, draw a pencil line at right angles to this straight edge far enough from one end to avoid any "checks" (splits) that may be there. Place the board across two boxes or other support, letting the marked end project. Put your left knee or foot on the board to steady it, and with the crosscut-saw (see *Handwork in Wood*, p. 64), saw off the end of the board just outside of the mark, Fig. 20. Be careful when you nearly reach the end of the cut to support the end of the board

with your left hand, so that you may cut clean to the edge. In a similar way, cut off two other pieces a little more than 16" long.

Mark one broad surface for a "working face." (See *Handwork in Wood*, p. 72.) If the board is slightly warped, mark the *concave* side.

II. *Planing the edges.* The next step is to plane one edge of each 16" piece perfectly straight and square with a broad surface. To do this proceed as follows: Put one piece in the vise, long edge up, and clamp it firmly. Attend to the adjustments of your jack-plane. (See *Handwork in Wood*, pp. 69-72.) Of these, there are 3 principal ones. 1, the cap (2)¹ to the cutter (1); 2, the Y adjustment (7); 3, the lateral adjustment (9).

Let us assume that the cutter is sharp. (If not, see *Handwork in Wood*, p. 59). In the first place, the "cap" or curling iron (2) should be screwed tight to the cutter (1) so that the edge of the cap is about 1/16" back from the edge of the cutter. Drop these two into the throat (19)

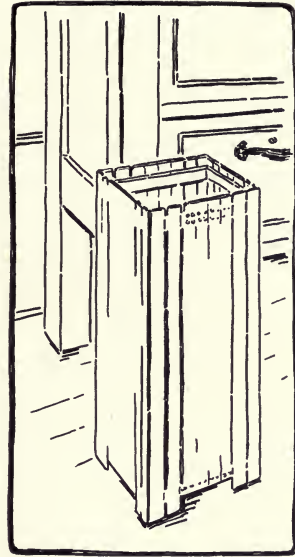

Fig. 14. A deep basket with feet made by shortening the central slats.

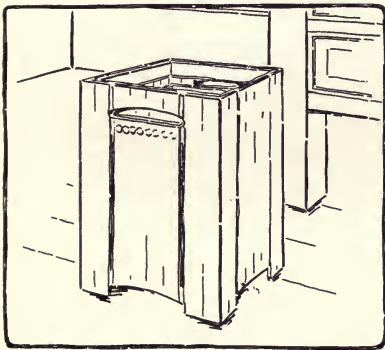

Fig. 15. A broad substantial basket.

of the plane, cap up, in such a way that the rectangular hole in the cap fits over the end of the "Y adjustment" (7). The clamp (4) is now buttoned over the clamp screw (5) and the thumb piece or clamp lever (20) pushed down tight. Now turn over the plane and look along the "sole" as in Fig. 21, and see that the cutter barely projects. You should see it as a thin black

¹These numbers refer to the numbers of the parts as given in Fig. 101 of *Handwork in Wood*, p. 69.

line across the shiny surface of the sole, Fig. 22. If it projects too far, bring it back by turning the brass set-screw (8). If one corner projects more than the other,

adjust it by means of the lever for lateral adjustment (9). Now try the plane on the wood. Grasp the handle (11) firmly in the right hand, and the knob (12) firmly in the left hand. Place the bottom or sole (16) on the edge of the piece in the vise, so that only the toe (17) (the part in front of the cutter), rests on the wood. Press down hard on the knob and push the plane forward. When the plane rests firmly on the wood, press equally on the knob and handle and then as the toe passes off the wood, press only on the handle. Finish the stroke with a slight upward swing of the plane. Be especially careful not to press down on the heel (18) at the beginning or on the toe at the end of the stroke. If you do, the surface which you are planing will not be straight but convex. Test the edge with the straight aris (the external angle formed by the union of two surfaces) of the plane, looking toward the light. (Fig. 23.) If the light does not come evenly between the edge of the board and the aris of the plane, plane off only the high part. Now test the edge for squareness, pressing the head of the try-square firmly against the side of the board and sliding it down until the blade just touches the edge, Fig. 24. Do this at several points along the edge, noticing which, if either, aris is higher than the other. If the left hand aris is higher, take off a shaving along that aris using only the right half of the cutter, that is, letting the

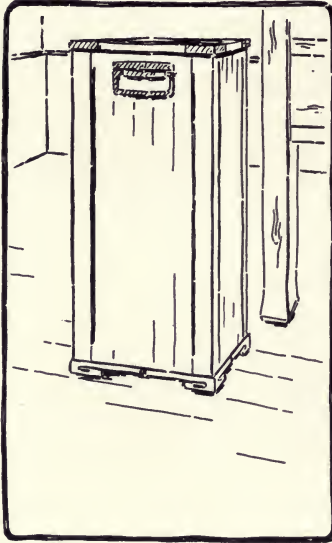

Fig. 16. Basket with plain copper handles and corner braces and with feet of carved blocks.

beginning or on the toe at the end of the stroke. If you do, the surface which you are planing will not be straight but convex. Test the edge with the straight aris (the external angle formed by the union of two surfaces) of the plane, looking toward the light. (Fig. 23.) If the light does not come evenly between the edge of the board and the aris of the plane, plane off only the high part. Now test the edge for squareness, pressing the head of the try-square firmly against the side of the board and sliding it down until the blade just touches the edge, Fig. 24. Do this at several points along the edge, noticing which, if either, aris is higher than the other. If the left hand aris is higher, take off a shaving along that aris using only the right half of the cutter, that is, letting the

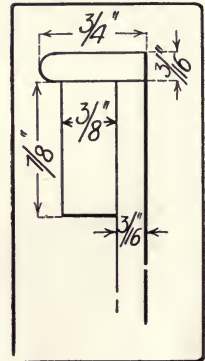

Fig. 17. Neat finish for top of scrap-basket.



Fig. 18. Basket with copper handles and copper nails.

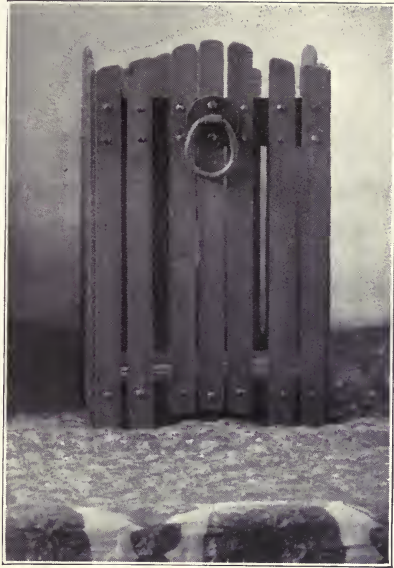

Fig. 19. Basket with copper handles and nails.



Fig. 20. Using a crosscut saw.



Fig. 21. Sighting along the sole of the plane to see that the cutter is properly adjusted.

left side of the sole of the plane overhang the board more than the right side, Fig. 25. But do not let it wobble. Repeat these tests and cuts until the edge is both straight and square. If the surface

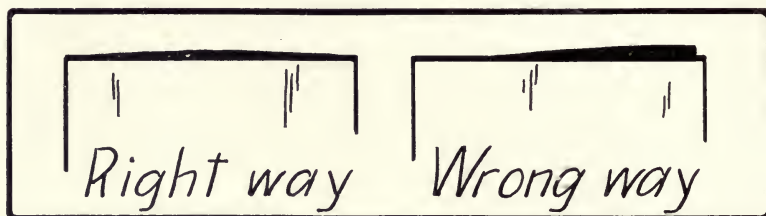

Fig. 22. Adjustment of plane cutter; sighting along sole of plane, as in Fig. 21.

you are planing appears torn and not glossy, you are planing "across the grain." In that case simply reverse the piece.

Repeat this operation on the other similar 16" piece. Put a pencil mark, thus =, on this edge for identification.

If you obtained your pieces from the mill exactly 16" long, and sawed square, the next two steps may be omitted. If you sawed off the two pieces yourself, their ends must be squared. To do this fasten one piece in the vise, end up. Cut off diagonally with the knife or chisel the arris (corner) away from the edge already planed for about $\frac{1}{4}$ ", as shown in Fig. 26.

The surface formed by cutting off an arris is called a *chamfer*.

Set your plane a little finer than for planing with the grain, and plane this end in the direction of the arrow, observing the same precautions as before.

This end must now be tested not only for straightness and for squareness with the surface, but for squareness with the edge already planed,



Fig. 23. Testing the straightness of an edge with the arris of the plane.

Fig. 27. Next measure exactly 16" from this end and, with a sharp knife-point and try-square, draw a fine line at right angles to the finished edge. Saw off the surplus outside of this line. Cut off the arris away from the finished edge and proceed as before.

Finally plane the other edge, taking pains to make it perfectly parallel to the first edge. Repeat all these processes on the other 16" piece.

III. *Laying out the slats.*

We are now ready to lay out the slats for the basket. This is done by drawing gage lines on the two opposite faces of both boards. To do this proceed as follows:

The lines are to be drawn as shown in Fig. 28. The spur

of the marking-gage should project from the beam about a quarter of an inch and should be sharpened (filed) to an edge as shown in Fig. 29, and in *Handwork in Wood*, Fig. 212. By having the spur long and turning the beam of the gage so that it rides on an arris, the spur will mark smoothly and evenly. Holding the marking-gage in



Fig. 24. Testing an edge for squareness.

the left hand, and the rule in the right hand (See *Handwork in Wood*, Fig. 213), set the distance from the head of the marking-gage to the spur at $3/16''$ and tighten the thumb-screw. Now hold the board with the left hand and the gage in the right hand (Fig. 214, *Handwork in Wood*).



Fig. 25. Holding the plane so as to square up a beveled edge.

Be careful not to grasp the beam as if it were a handle, but turn the wrist to the left so

that the thumb presses on the beam behind the spur. Do not try to make a scratch at first, but run the gage up and down the board

with the beam resting on one arris, Fig. 29, and the head sliding along the edge of the board (as in Fig. 214, *Handwork in Wood*).

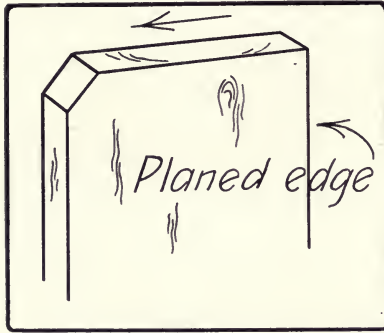

Fig. 26. Arris chiseled off to prevent splintering in planing end wood.

Now little by little roll the beam toward you until the spur just begins to scratch. By practicing in this way for a little while, you will soon learn to gage a line parallel with the edge. The difficulty that most beginners experience comes from trying to scratch a deep line at once, and in not getting the pressure behind the spur. The finest line that is visible is best. As the distance between the spur and the head of the gage increases, so does the difficulty of holding the gage steadily. If you are not succeeding well, practice on only one board, and if the result is too bad, plane off the scratched surface, and try again and again until you can use the gage well. (See p. 48 for broad surface planing.) It is better to lose one board than two.

Now gage this $\frac{3}{16}$ " line on both broad surfaces from the same edge. Then others on both broad surfaces from the other edge, and then others on the other 16" board in the same way.

Now add $\frac{1}{4}$ ", setting the gage at $\frac{7}{16}$ " and gage again the eight lines. Then add another $\frac{3}{16}$ ", making $\frac{5}{8}$ " and gage again. Add another $\frac{1}{4}$ ", and so on, until you have 28 $\frac{3}{16}$ " spaces, counting from both edges of both boards.



Fig. 27. Testing squareness of end.

IV. *Ripping off the slats.*

When the two boards are properly gaged, they are next to be rip-sawed up into slats. *The saw kerfs are to be down the middle of the $\frac{1}{4}$ " spaces.* To be sure of making no mistake, it is well to draw a pencil line where the kerfs are to be.

To saw proceed as follows: Fasten one board in the vise as in Fig 30, *i. e.*, with the jaws of the vise pressing the edges of the board, and the board inclined back from the perpendicular.

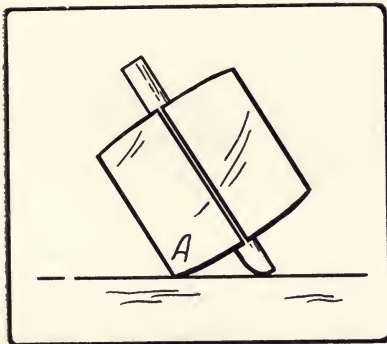

Fig. 29. How the beam of a marking-gage runs on its arris.

Rest the left hand on the top end of the board with the thumb so held that it acts as a guide in starting the saw. The saw to be used is the rip-saw (see *Handwork in Wood*, p. 63). Hold it in the right hand so that the line of the teeth and the surface of the board make quite an acute angle; that is, drop the right hand down as low as possible. Put the saw in proper position for making the cut, and be careful to hold up the saw so that the teeth will rest on the arris as lightly as possible. If these directions are followed, it will not be necessary to make a false start by drawing the saw toward you, but the first stroke will be a push and will cut properly. Now saw away the pencil line in the middle of the $\frac{1}{4}$ " space, watching the line closely and also looking on the



Fig. 28. Gaged lines on piece to be sawed into slats. The saw-kerfs are to be in the middle of the $\frac{1}{4}$ " spaces.

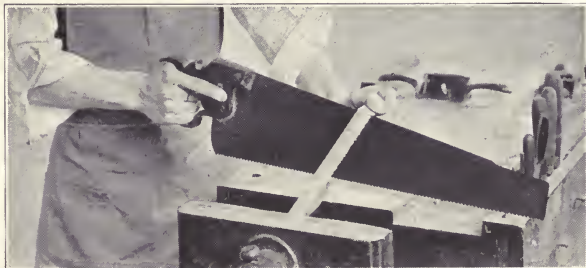

Fig. 30. Ripping with wood held in vise.

back to see if the kerf is in the middle of the space. If the saw tends to "run" to one side of the line, say the right side, pull it back nearly to its point, twist the handle a little to the left, and take a few short strokes until the kerf is in the proper place again. If the cut is going badly on the back, it may be necessary to turn the board back side front, until the kerf is right there.

Saw about half way thru the board, then turn the other end up and saw the other half.

After sawing off the strip, put the board in the side-wise, sawn edge up, and plane it down to the next gage line, being careful not to

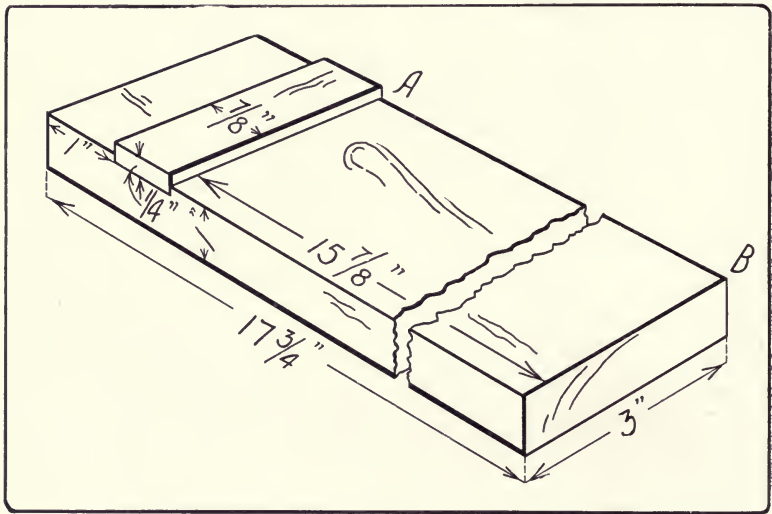

Fig. 31. Device for holding thin strips for planing.

go below it and yet to make the edge true. This is slightly more difficult than it was to plane it true in the first place. Then saw off another strip as before, plane up the edge of the board, and so on, until the necessary number of strips (28) have been sawn off. By this time one should know how to rip-saw well. By cutting 14 slats from each board, a part of each board will be left which should be saved to be used later for the frame.

V. *Planing up the slats.* The slats are now to be planed on the side still rough. If your bench has a tail vise, fasten one of the strips between the stop in the vise and the bench-stop, placed in that

hole which is at the right distance, and plane it to the proper thickness. The same can be done between the vise-dog and the bench-stop in the Sheldon vise, but since the parts are of iron, special pains must be taken to prevent the plane cutter from hitting the iron. To avoid this danger, put in a temporary wooden bench-stop. Another device for facilitating the planing of these thin strips, is shown in Fig. 31 and can be readily made, as follows:

In any convenient piece of wood, 18" or so long, cut a dado $\frac{1}{8}$ " deep, and 1" from one end, just wide enough to hold tightly a thin strip of wood (say $\frac{7}{8}$ " wide). Let the distance A B be $\frac{1}{8}$ " less than the length of the strips to be planed up. Insert this device between the vise-dog and the bench-stop letting the strip to be planed lie in the space A-B. Raise the vise-dog so that it will engage the strip. Then tighten the vise just enough to hold it firmly. Plane up all the strips to the required thickness. If any are spoiled, as is likely to be the case, in this first project, make others, but save the spoiled ones until the basket is done.

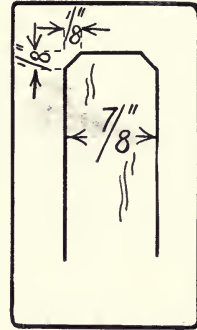

Fig. 32. End of slat.

Next trim off the arrises (corners) at one end of each of the slats, see Fig. 32. First mark carefully $\frac{1}{8}$ " from the end and then draw the diagonal with a sharp pencil and the sliding Tee-level. The neatest way to cut this angle is by slicing it off with a chisel, see Fig. 33. Cut these angles at one end only.



Fig. 33. Slicing off an arris with a chisel.

VI. *Making the bottom.* Inasmuch as the thickness of the original boards and hence the width of the slats

may not be exactly $\frac{7}{8}$ ", in order to find out the exact size of the bottom proceed as follows: Lay seven slats close together, side by side, measure their total width and add six times $\frac{3}{16}$ ", (the space be-

tween the slats) or $1\frac{1}{8}$ " in all. The total is the exact size of the bottom. Let us assume that the slats are exactly $\frac{7}{8}$ " wide. Then the proper size for the bottom will be $\frac{3}{4}$ " x $7\frac{1}{4}$ " x $7\frac{1}{4}$ ". This is to



Fig. 34. Testing a planed surface for flatness by using the arris of the plane.

be made next, and this involves broad surface planing. Fasten the board flat on the bench, between the tail-vice-dog and the proper bench-stop, the grain running lengthwise of the bench. If the board is at all warped, plane the convex side first. Before beginning to plane, glance down the sole of the plane, Fig. 21, to see that the little cutter projects evenly and but very little beyond the sole. Test the surface for flatness by placing the long arris of the plane on the surface in various directions, lengthwise, crosswise, and diagonally and looking toward the light, as in Fig. 34. If there are high places, plane them off first. Work carefully, planing only such parts as need it. When the surface is flat, plane over the whole surface from end to end, working from left to right, and back again until the whole surface is smoothed. Mark this surface with a single mark, thus: —. This indicates the "working face." Now plane one edge true and mark it with two marks, thus =. This indicates the "working edge." It is important to form early this habit of marking one's work. Next draw with a sharp pencil and a straight edge, a line $7\frac{1}{4}$ " from, and parallel to the working edge. Since this distance exceeds the number of inches on the marking-gage, the most convenient method is to measure the distance near each end, and at right angles to the working edge, and then to rule a light



Fig. 35. Scoring with a knife along the try-square.

line between these two points. Next score with the knife and try-square, as in Fig. 35, a line near one end of the piece. The working face will now appear as in Fig. 36.

Cut off the corner *A*, as in Fig. 36, put the piece end up in the side vise, and plane off the end to the scored line. Test this end

with the try-square, to see that it is square with both the working face and the working edge. Then measure exactly the length, $7\frac{1}{4}$ ", and score it with knife and try-square. Cut off the corner outside the width line, and plane up the other end.

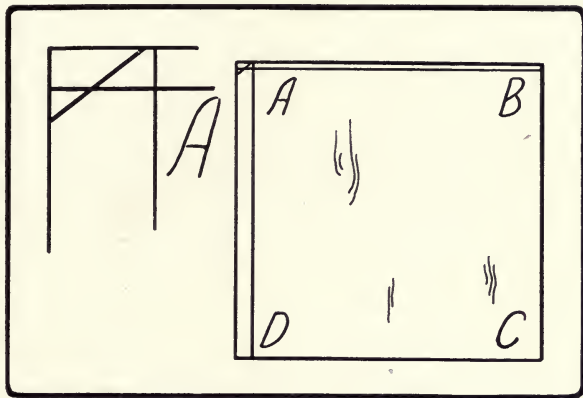

Fig. 36. How the working face looks when marked for planing end *AB*.

Plane the width, $7\frac{1}{4}$ ", to the ruled line. Use the try-square constantly for testing. The piece should now be perfectly square. To verify your measurement see that the diagonals are equal in length. $AC = BD$.

With the marking-gage set at $\frac{3}{4}$ ", gage from the working face both edges and both ends of the board. Now plane down the other broad surface to the line thus gaged, being very careful not to plane any portion too much. The best way is to plane off the high places first and then by working back and forth across the board to reduce the whole surface evenly. Stop when you have just split the gaged line.

VII. *Making the frame.* The next step is to get ready the frame, which binds the slats together near the top. From one of the pieces left from making the slats, dress up one piece, $\frac{7}{8}$ " thick, $1\frac{3}{4}$ " wide, and 16" long. Smooth the two broad surfaces, taking as fine shavings as possible.

Plane true one edge of the piece, and gage a line $1\frac{3}{4}$ " from the edges. Saw off the surplus and plane to the line. Now gage two lines, $\frac{5}{16}$ " from each broad face. Saw between these two lines, and

plane up the rough surfaces. Each of the two strips should be $5/16$ " thick. Cut each of these in two crosswise in the center making 4 cleats.

"The pieces made thus far may now be sandpapered. Tear a sheet of No. 1 sandpaper into four pieces. An easy way to do this is to place it, sand down, so that the middle of the sheet lies along the front arris of the bench. With the left hand hold the part on the bench down flat. With the right hand holding the other half give a quick downward stroke which will tear the paper straight in two, Fig. 37. Repeat on each half. Fold one quarter neatly around a small block



Fig. 37. Tearing sandpaper.

downward stroke which will tear the paper straight in two, Fig. 37. Repeat on each half. Fold one quarter neatly around a small block

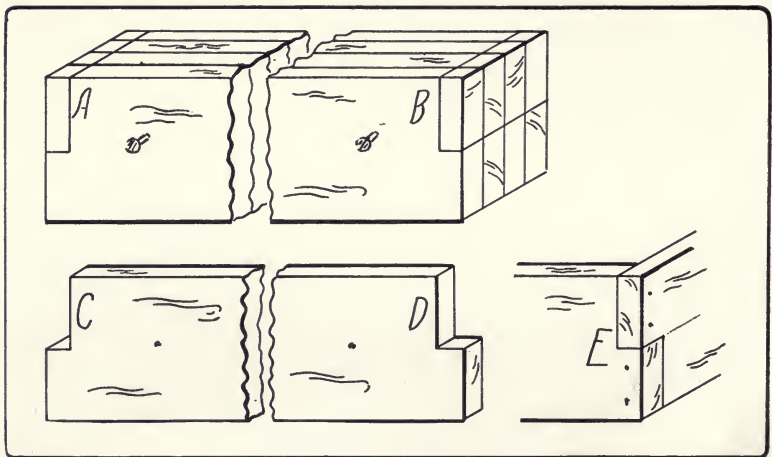

Fig. 38. Method of making and joining frame of waste-basket.

of wood (say 3" wide) and with this tool, sandpaper *with the grain* every surface of each piece, and also touch off the sharp arrises.

VIIIa. *Making the frame (end lapped)*. First with a couple of brads (1¼" No. 15) nail all four cleats together, keeping the sides and one end perfectly flush,

and letting the heads project so that the brads can be removed later. Then saw them together in the miter-box to exactly the length of one side of the bottom 7¼". Next measure carefully 5/16" from both ends and draw a line half across on one surface, and connect with these lines two other center lines as at *AB*, Fig. 38.

Place the bunch in the miter-box again, and saw on the outside of the lines *AB*, and carefully chisel out these returns.

Take the cleats apart and each will appear as *CD* in Fig. 38. Now nail the four together into a frame, reversing two of them so that the projection of two of them will fit into the return of the next ones as *E* in Fig. 38. Nail both ways.

VIII b. *Making the frame (mitered)*. If the cleats binding the slats together are fastened, not inside of the slats, but outside, as in Fig. 10, the ends should be mitered.

Mitering is done in the miter-box. If you have a simple wooden one, fasten it in the vise so that it will be rigid, as in Fig. 39. Place

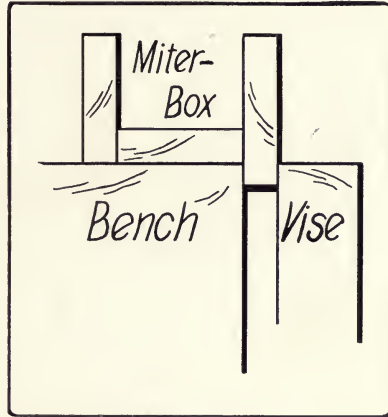

Fig. 39. Miter-box in vise.

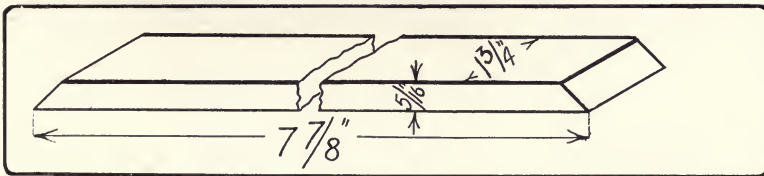

Fig. 40. Cross-cleats for scrap-basket.

one of the cross-cleats in the trough of the miter-box, *edge up*, and with the back-saw slid into one of the 45° kerfs, cut off the cleat

near the end. Do this for all 4 cleats. Now measure accurately the length ($7\frac{7}{8}$ " outside length), put the saw in the other 45° kerf and saw off the other ends. Each cleat will now be of the shape shown in Fig. 40. Test each cleat to see that the end is square with the edge, and that all are of the same length. If not, the ends can be trimmed with a chisel.



Fig. 41. Trimming a miter.

With chisel pare off sawn mitered surface until it is true. See that

all four cleats are alike, $7\frac{7}{8}$ " long, and with a true 45° miter at each end. In order to test this, set your sliding Tee-level at an angle of 45° , as follows: Measure accurately both ways from the corner of a known right angle. Set the head of your sliding Tee-level against one

edge and set the blade so that it will just touch these two points, as in Fig. 42. The acute angle will be 45° . If you have an accurate iron miter-box, cut a true 45° angle on a piece about 3" wide, and set your Tee-level by this. In case

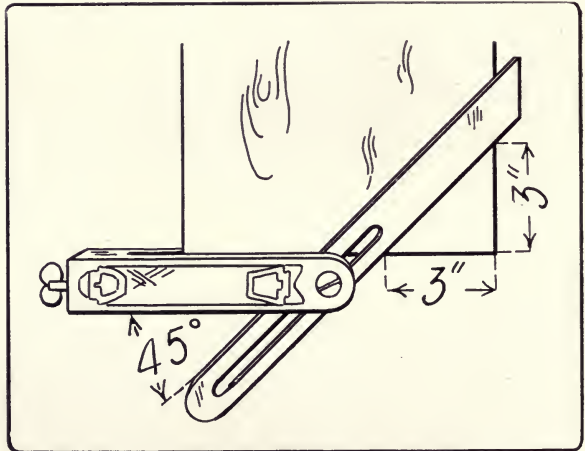

Fig. 42. Setting a sliding Tee-level to an angle of 45° .

the cross-cleats are mitered, as in Fig. 40, it is necessary to reinforce the joints by means of tin or copper angles. These are made

thus: With the scratch awl or a sharp nail draw a center line (diameter) thru a piece of tin 2" x 2 1/2". On this center line lay off four 3/8" spaces. With the scratch awl and sliding Tee-bevel set at 45°, draw oblique lines both ways from the center line as shown in Fig. 43. With the snips (or a pair of strong scissors) cut out the four braces in the shape shown in Fig. 44. Each one should be just less than 5/16" wide. With a small nailset punch four holes in each piece as shown in Fig. 44. The best way to do this is by placing the tin on a piece of lead, but a piece of hard wood will do. Do not use the top of the bench.

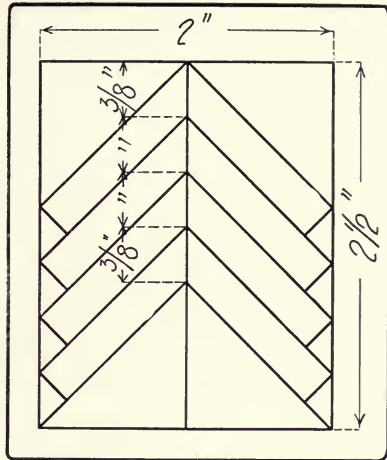

Fig. 43. Lay-out of the tin braces.

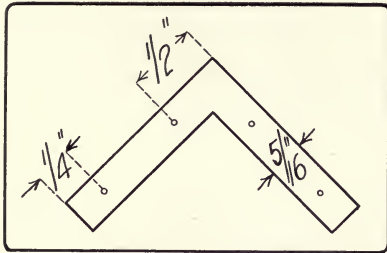

Fig. 44. Tin brace.

Then flatten out the tins. Do not use the top of the bench.

Next nail together the frame by means of the tin braces and the 5/8" flat head nails as shown in Fig. 45. The joints may also be strengthened by driving brads (7/8", No. 18) at *A B C*, Fig. 45. To do this fasten one piece *X* firmly in the vise, end up, start the nails *A* and *B* in the other

piece (*Y*). Force the end of piece *Y* a little beyond the end of *X*, so that when the brad is driven home the outer arrises of the miter will just meet. Do this with all the corners, and lay aside.

IX. *Assembling.* The parts are now ready to be assembled. On one long arris of one of the slats, lay out with a sharp pencil and a rule, the position of the slats as in Fig. 46. Using this as a pattern, lay out the same dis-

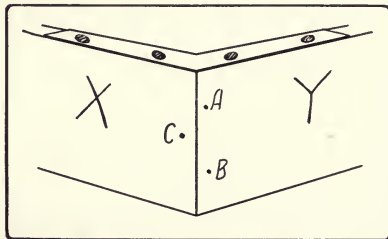

Fig. 45. Tin brace nailed to cleats.

tances on all the upper arrises of the bottom, and on the corresponding arrises of the frame. Next, nail the slats to the bottom piece, as in Fig. 47, driving only one brad ($\frac{7}{8}$ " No. 18) thru each slat, and that one a little away from the center, so as not to interfere with the



Fig. 46. Position of slats.

upholstery nail, which will be driven in later, and yet near enough to the center so that it will be covered by the head of the upholstery nail. The lower end of each slat will be just flush with the lower surface of the bottom.

The next step is to nail the slats to the cross-cleats which have already been joined together into a frame.

Measure $1\frac{1}{4}$ " from the top end of the four corner slats on the inside. Lay the basket on its side and drive brads from the inside of the basket thru the cross-piece just far enough into the corner slats to hold the frame in place. Later these brads are to be removed. See that the basket stands square in all parts. Now with upholstery nails, nail each slat in its proper place to the frame. These nails should be in two rows, so disposed that the point of each nail is in the vertical center of the slat, and half an inch from one edge of the frame, as shown in Fig. 48.

In order to have something solid to nail against, open the vise wide enough so that the inside of the basket can rest on the outer jaw. Or cut a stick of wood just the length to fit snugly between two opposite cross-cleats, and fit it between them. Or, something heavy like

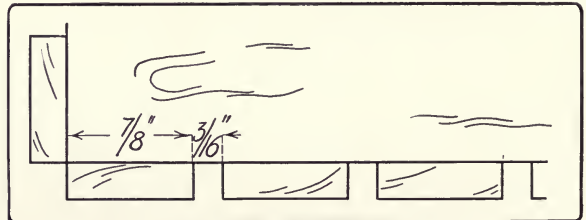

Fig. 47. Arrangement of slats.

a hammer or a flat iron, may be held inside with one hand, while the other drives the nail. If the point of the upholstery nail projects thru, clinch it; that is, drive it against a piece of iron. Proceed until all the nails are driven.

X. *The feet.* The construction of the basket may now be considered done, but it will be improved in looks by the addition of little feet at the four corners, see Figs. 9 and 49. They may be

made in this way: From a $\frac{7}{8}$ " board, 16" long, saw off and plane two pieces to $\frac{5}{8}$ " thick. In the miter-box cut these into 4 equal rectangular pieces 7" long. From the rectangular end, cut out with the back-saw and trim with the chisel returns as *A* in Fig. 49. Cut each of these in two in the miter-box at an angle of 45° , making the shape shown in Fig. 49. Holding the piece in the vise for convenience, with the veining tool, or the sharp point of a knife, cut out the decoration and chamfer off the long outer arsis. (*See Hand-work in Wood*, p. 184.) These feet may now be nailed in pairs on

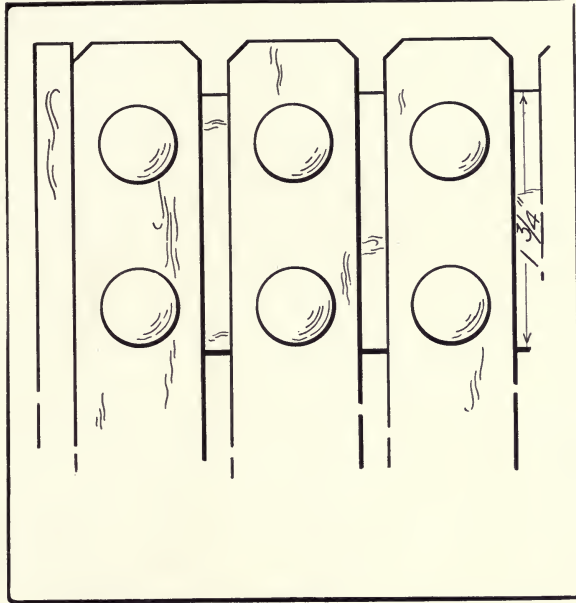

Fig. 48. Arrangement of upholstery nails.

the shape shown in Fig. 49. Holding the piece in the vise for convenience, with the veining tool, or the sharp point of a knife, cut out the decoration and chamfer off the long outer arsis. (*See Hand-work in Wood*, p. 184.) These feet may now be nailed in pairs on

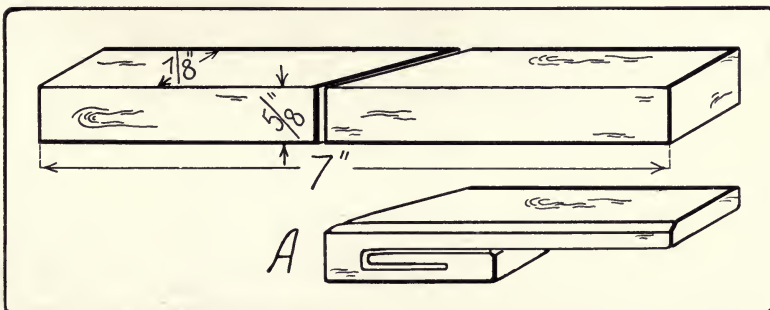

Fig. 49. Feet of scrap-basket.

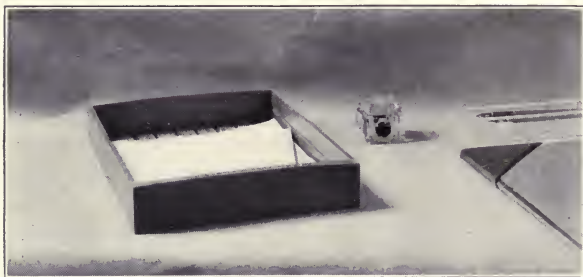

Fig. 50. Letter tray made of slats.

is now ready to be stained. First see that all surfaces are smooth and clean and free from pencil marks. Pour a little of the prepared

the corners of the bottom, projecting outside of the slats just the width of the chamfer. See Fig. 7.

XI. *Finishing.* The basket



Fig. 51. Box screen for flowerpot.

brown stain in a cup, and begin to apply with a brush on the inside of the basket. After staining a portion and before it dries, wipe the stain off with cotton waste (obtainable at a paint store) or with an old cloth. In this way stain and wipe the entire surface. Then let the stain thoroly dry, 24 hours, before waxing with "Old Dutch Finish." If the wax is hard, soften it by placing the can in hot water. Smear it over the surface with a brush, and let it dry over night. Then rub with a piece of soft cloth, cheese cloth, for instance. The more rubbing the better will be the polish. No more wax is needed.

The principal processes in this first project are the sawing and planing of a number of cleats. Other projects involving the same processes are (1) the letter tray shown in Fig. 50. The slats on the sides and bottom are rabbeted into the ends and nailed in place with brads. (2) The box screen in which a flower-pot may stand, Fig. 51. The construction of this is the same as that of the scrap basket. (3) The leaf-press, Fig. 52. This consists of a pair of frames each made of seven slats nailed to four cleats. These are tied tight together with a bunch of newspapers between.

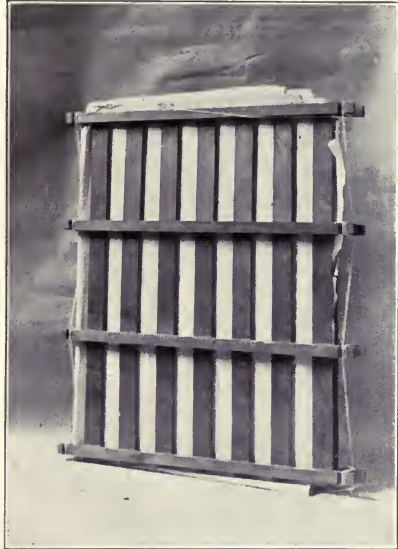

Fig. 52. Leaf press.

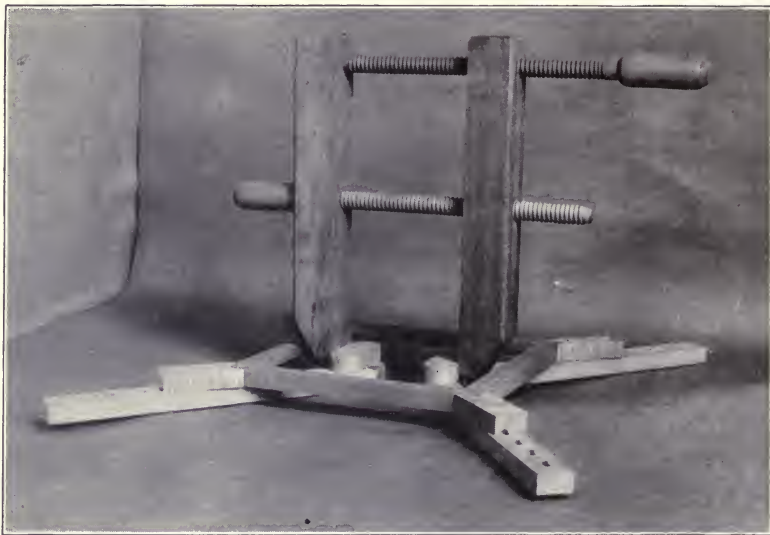

Fig. 53. Picture-frame-clamp.

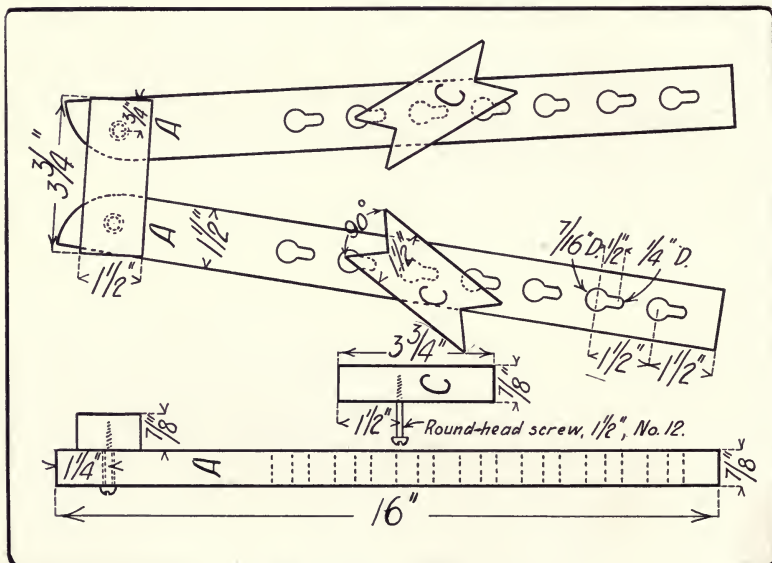

Fig. 54. Picture frame-clamp.

CHAPTER V

PICTURE-FRAME-CLAMP

Design. A picture-frame-clamp is of good design when it serves its purpose well. As shown in Fig. 53, this clamp meets this requirement. In Fig. 54, the details of its construction are made plain. The two long arms, *A, A*, by pivoting on a hinge, and by means of a series of holes in them, make it possible to adjust the clamp to frames varying in proportions and sizes, while the two small pieces, *C, C*, into the 90° angles of which the frame fits, are made adjustable by pivoting at these holes. A pair of these clamps is necessary for gluing up one frame. When set up as shown in Fig. 53, the joints of the frame are pulled tight into place by means of a handscrew. As here designed, this clamp will serve for frames from 6" x 9" to 18" x 24". To be of use it must be accurate, but there is no necessity for making it over-nice.

The woods selected are yellow poplar (medium strength and easy to work) and maple (very strong). But if the clamp is to be used often, maple should be used thruout.

Finish. To prevent the glue in the picture-frame from sticking to the clamp, a coat of boiled linseed oil is applied all over the clamp.

The following materials are required:

Yellow poplar, or other medium strong wood, $\frac{7}{8}$ " x $6\frac{1}{2}$ " x 17",

Maple or oak, $\frac{7}{8}$ " x $1\frac{1}{2}$ " x 26",

8 round-head screws, $1\frac{1}{2}$ " No. 12,

And a little boiled linseed oil.

I. *Making the arms.* First see that your plane is sharp and otherwise in good order (See *Handwork in Wood*, pp. 76 and 58). The long pieces (arms) are to be of yellow poplar and each is

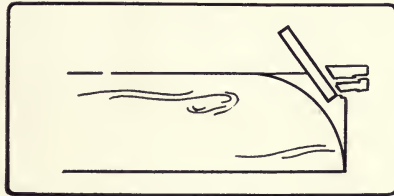

Fig. 55 Method of perpendicular chiseling.

$\frac{7}{8}$ " x $1\frac{1}{2}$ " x 16" in size. To get them out, first smooth one broad surface, if it needs it, then plane one edge of the board straight and square. Gage a line $1\frac{1}{2}$ " from this edge, rip-saw it off, dress up the edge again, and repeat, until you have the four required pieces. Plane these pieces to $1\frac{1}{2}$ " wide. With the back-saw saw off one end



Fig. 56. Perpendicular chiseling.

of each piece square in the miter-box. With the dividers, lay out a quarter-circle on the broad side of the other end of each piece, Fig. 55. Next trim off the waste by sawing off the corner and then by means of "perpendicular chiseling" (*Handwork in Wood*, pp. 56-58). Or chiseling alone may be employed. Proceed as follows: Lay one of the pieces flat on a piece of waste wood or a cutting board. Grasp the handle of the 1" chisel, in the right hand, thumb up, Fig. 56, (*Handwork in Wood*, Fig. 72) and let the blade of the chisel pass between the thumb and the first finger of the left hand, which rests, back down, on the work, and holds it in place. The right hand pushes the chisel downward, and the left hand controls its position. Trim off the waste outside the quarter circle, *a little at a time*.

If more force is required push with your chest against the end of the chisel handle. If still more force is needed, use the mallet in your right hand, grasping the blade of the chisel in your left hand (*Handwork in Wood*, Fig. 76). Always work around from the side to the end (Fig. 75, *Handwork in Wood*); otherwise you are likely to split the piece. When you have cut nearly to the line, set the piece up diagonally in the vise so that the quarter circle is up, and

pare off shavings with the chisel, flat side down (as in Fig. 74, *Handwork in Wood*). The right hand pushes the chisel forward while the left thumb pushes it sidewise, thus giving a diagonal cut. Trim all the pieces in this way. Another method of trimming a curve is by means of the spokeshave. This is in reality a plane with a short sole, so made in order that the cutter can follow curves. It is held in both hands as in Fig. 57, and it may be either pushed or pulled. Before beginning to use it, see that



Fig. 57. Using the spokeshave.

the cutter is sharp and properly set. In the kind recommended above (p. 30) the width of the throat may be adjusted by means of the thumb-screw. This also alters the depth of the cut. With

this tool trim off the quarter circle. By turning the blade diagonally to the direction of the cut, it will be found to work more easily and reliably.



Fig. 58. Stepping off distances with the dividers

Next gage a center line from end to end on both broad sides of each piece.

Then set the di-

viders at $1\frac{1}{2}$ " between points and beginning at the square end, step off and prick in this center line 7 points, Fig. 58. Repeat this process

on the other side and do it on all four pieces. Then set the compass at $\frac{1}{2}$ " between points and starting from each point already pricked, prick 7 other points toward the rectangular end. Also make a mark on the center line $1\frac{1}{4}$ " from the other (quadrantal) end.

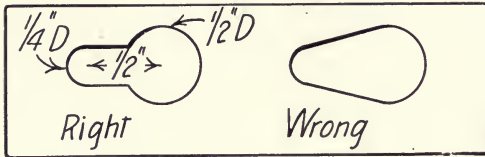

Fig. 59 Shape of holes in picture-frame-clamp.

Now bore the holes, first the $\frac{7}{16}$ " holes at the points first pricked, then the $\frac{1}{4}$ " holes, at the points $\frac{1}{2}$ " from these. To insert the bit in the brace, hold by the left hand the sleeve of the chuck, pointing it upward, and revolve the handle with the other hand until the jaws open enough to receive the tang of the bit entire. Drop in the $\frac{7}{16}$ " bit, and reverse the motion until the bit is firmly gripped (Fig. 186, *Handwork in Wood*). Fasten one of the 16" pieces in the vise (Fig. 137, *Handwork in Wood*) flat side up, taking care to have it parallel with the top of the bench in order to help bore straight. Take the brace in the right hand and the bit in the left, and insert the point of the bit in the prick $1\frac{1}{2}$ " inch from the end. Now grasp the knob of the brace in the hollow of the left hand. Set the try-square upright near the work

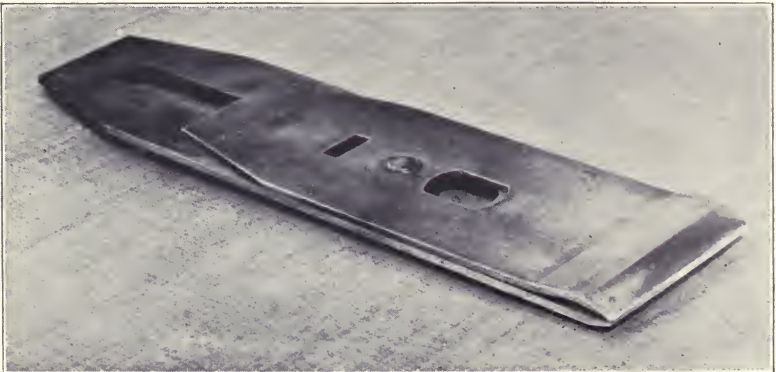

Fig. 60. Plane cutter and cap.

and sight from two directions, at right angles to each other, so as to see that the bit is perpendicular (Fig. 137, *Handwork in Wood*). Revolve the handle clockwise, bore about half way thru, then bore the next hole ($1\frac{1}{2}$ " from the first) and so on, till all the holes in one

side are bored. By counting the revolutions while boring, you can quickly learn when to stop. Turn the piece over and bore in the corresponding pricks on the other side. Bore the holes in all the pieces. Remember that unless the work is accurate, the clamp will be of no use as a clamp. Then insert the $\frac{1}{4}$ " in the brace and bore the other set of holes in the same way. Bore a $\frac{1}{4}$ " hole at the mark which is $1\frac{1}{4}$ " from quadrantal end.

The next step is to cut out the space between each $\frac{1}{2}$ " and $\frac{1}{4}$ " hole, making a buttonhole shaped opening, Fig. 59. Lay one piece down flat on the cutting board. Grasp the chisel as for perpendicular chiseling (see above), cut out an opening between the two holes, which shall be V-shaped in cross-section, but tangent to the outside of the small hole; that is, parallel to the sides of the piece. Gradually deepen this cut. Turn the piece over and repeat until you can cut clear thru it. Cut till the opening is tangent to the outside of the $\frac{1}{4}$ " hole all the way thru, as in Fig. 59. There are 28 of these openings to cut.

II. *Making the blocks.* Next prepare the small pieces of hard wood. They are all $\frac{7}{8}$ " thick, $1\frac{1}{2}$ " wide, so plane them while they are all in one piece. In planing this hard wood, be content with taking quite fine shavings. Otherwise your plane is likely to be "choked." But if it does choke, do not try to pick the shavings out of the throat with another tool. This is likely to injure the cutter. Rather take the cutter out of the plane by first removing the clamp. If the shavings are wedged between the cutter and the cap, loosen the screw which holds them together using the edge of the clamp as a screw-driver, and remove the shavings and reset the cap, placing the edge of the cap quite close to the edge of the cutter ($1/32$ "). See Fig. 60. Re-insert the cutter in the plane, adjust it carefully and proceed.

When the piece is properly planed up, saw it up into the right lengths; namely, 6 pieces, $3\frac{3}{4}$ " long.

Set the sliding Tee-bevel at 45° (see p. 52) and mark out 2 internal angles on both ends of 4 of the pieces, as shown in the drawing.

Set these diagonally in the vise; trim off with the chisel a little of the arris across the thickness, and with the back-saw, saw out the angle as accurately as possible, Fig. 61.

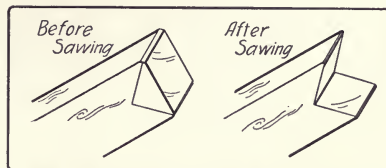

Fig. 61. Method of sawing stop blocks of Picture frame clamp.

If an accurate miter-box is available (like the Stanley or Langdon) these notches may be accurately cut thus: Cut a 45° angle on a piece of wood 4" wide, and clamp this to the fence of the miter-box in such a position that the saw will just rest on the end arris of one of the $3\frac{3}{4}$ " pieces as in Fig. 62. Saw to the center and repeat.

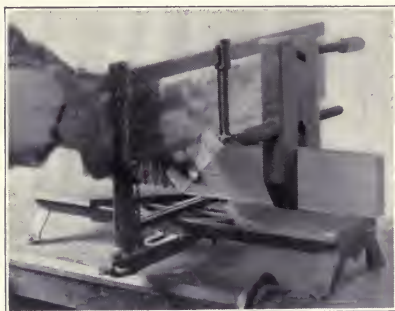

Fig. 62. Cutting notches in ends of blocks in the miter-box.

Smooth up the cuts with a sharp chisel, testing them to see that they are square with the broad side and make a true 90° angle with each other.

On each of these four blocks locate a point $1\frac{1}{2}$ " from one end and in the center sidewise, with a No. 5 gimlet-bit (number stamped on the tang), bore a hole partly thru, and screw in a round-headed screw ($1\frac{1}{2}$ " No. 12) until the head is $\frac{7}{8}$ " from the surface, as shown in the drawing. You should be able to button this firmly into one of the openings which you have made in the long pieces.

Next prepare the hinge pieces ($\frac{7}{8}$ " x $1\frac{1}{2}$ " x $3\frac{3}{4}$ "). Bore a hole (with No. 5 gimlet-bit) $\frac{3}{4}$ " from each end, part way thru. Slip a round-head screw ($1\frac{1}{2}$ " No. 12) thru the hole at the quadrantal end of one of the long pieces and screw it into the hole just made in the hinge piece. The hinge piece should be screwed firmly down to the long piece but the joint should turn easily.

Insert screws in all 4 of these holes, making two hinged parts. Now oil all the parts with a coat of boiled linseed oil and wipe off with cotton waste.

Other projects involving the boring of holes are shown in Fig. 63.



Fig. 63. Projects involving boring.

CHAPTER VI

THE MITERED PICTURE-FRAME

I. THE FRAMING OF PICTURES

The first thing to do in making a picture-frame is to select the picture, because such details as the use of a mat, the size, proportion, tone, and decoration of the frame, all depend upon the character of the picture. Furthermore, the picture should be one well worth framing. To select a picture that is not beautiful, is but to honor what should be ignored.

To be able to frame good pictures well, then, is the ideal to be kept in mind in learning to make picture-frames.

The suggestions here given are intended to apply only to the selection and the framing of comparatively small pictures, such as photographic and chromolithographic reproductions and Japanese color prints. In these days of cheap reproduction, good pictures of this class are inexpensive and readily secured. In the periodicals are to be found excellent reproductions of the work of some of the greatest living artists, such as Maxfield Parrish, Jules Guerin, John W. Alexander, Edwin Abbey, Frank Brangwyn, Gari Melcher, Pamela Colman Smith, and Jessie Wilcox Smith, to mention a few. Also Japanese color prints as well as photographic reproductions of universally recognized European and American masters may be procured at the best art stores.

For the novice, a sufficiently safe guide to the choice of good pictures, is to select from the works of these artists. However, a study of Prof. Arthur W. Dow's "*Composition*," would go a long way toward enabling the student to select wisely his own pictures for framing.

When it is remembered that the frame is made for the picture and not the picture for the frame, then it follows that the frame is to be so designed as to set off the picture to the best advantage.

As to the adaptation of the frame to the picture, in the first place, the mat may properly be considered as a part of the frame. It,

like the frame, is a device to give a setting to the picture. Whether or not a mat is to be included in the framing of the picture, depends somewhat on the location of the picture in the room, as well as the

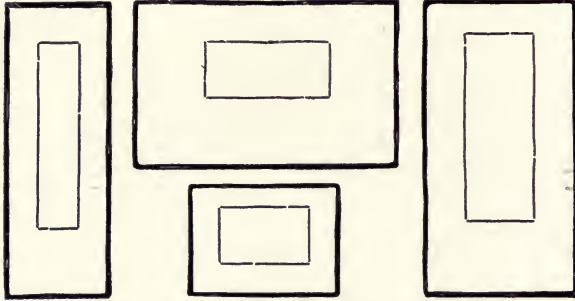

Fig. 64. The mat makes possible the introduction of interesting proportions in the framing.

idea one has in mind in framing the picture, and the character of the picture.

In favor of the mat, it is to be remembered that an ordinary mitered frame by itself

involves the necessity of having all the margins around the picture equal in width; whereas, by the use of a mat, this monotony can be avoided and a subtle and pleasing variety produced, as in Fig. 64.

As to the size of the mat: If there is to be a mat it should be large enough to be effective. A mat that is only a little larger than a picture looks as tho it were a mere device for splicing out the picture to fit the frame. On the other hand the picture should not look lost in the mat.

As to the width of the margins of the mat: one consideration to be borne in mind is the shape of the entire frame resulting from the introduction of a mat. As a general rule it is safe to say that the margins should not be such as to produce a square frame for an oblong picture. See Fig. 65. A little observation will show that squareness in either picture or frame is commonly avoided by artists. An oblong is less monotonous and hence more pleasing than a square, just as an ellipse or other varied curve is more pleasing than a circle. As to the proportions of the oblong, simple multiples are to be avoided; that is, the ratio of the short side to the long side should be not simply 1 to 2 or 2 to 3, but a more subtle relation.

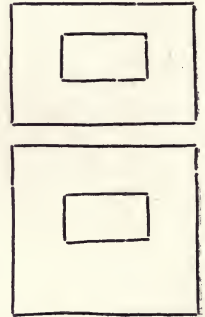

Fig. 65. The upper arrangement of spaces is good because it conforms to the proportions of the picture. The lower one is not good because the square frame is out of harmony with the long picture.

If the margins around a picture are widened uniformly on all sides, what was originally a pleasing rectangle will lose its good proportions, but they may be kept good by increasing the length of the mat more than its width, Fig. 65. It is a safe rule for the amateur never to place a picture elsewhere than in the vertical center of the mat, nor to place a horizontal picture in a vertical frame, as in Fig. 66. Such arrangements are in danger of appearing like affectations.



Fig. 66. These arrangements are likely to look like affectations.

To secure harmonious color and value in the frame, the same tones and values that predominate in the picture may be repeated in the frame; for instance, for Maxfield Parrish's



Fig. 67. Plain oak frame, stained a golden brown to harmonize with the predominant yellow tone of the picture. Maxfield Parrish's "Autumn."

"Autumn," Fig. 67. The frame is finished in yellows matching the color in the picture. Or the harmony desired may be secured by the introduction of a strong contrast, as a blue mat for a picture predominating in orange. Or, for a contrast in values, for instance where grays are used as in photographs, a white mat with a black frame is effective.

As to the width of a frame, it is difficult to make any rules that will definitely and easily solve all cases, but a few suggestions may be

found serviceable. The width of a frame and its value bear a close relation, in their effect on a picture, as follows:

• A wide frame finished dark is appropriate for a picture predominating in darks and massive in treatment, as in Fig. 68.

Or a wide frame finished light (Fig. 69) sets off well a picture light in value and broad in treatment, and so on, thru all the intermediate grades from very dark to very light.

A narrow frame finished very dark, looks well around a picture where darks are used sparingly and delicately, as in some Japanese prints. See Figs. 70, 71, 72.



Fig. 68. Wide dark frame for a picture with broad dark masses; frame toned to dull brown of photo.

So, in like manner, a narrow and very light frame would be used only for a picture in a very light key and of a very delicate treatment, as in Fig. 73, 1 and 3.

Where a mat is part of the framing of a picture, the frame and mat may vary in tone and value, in such a way as will not only not interfere with the unity of the picture, but will still further enhance its beauty. It is often possible further to unify

the picture and its frame by repeating in the frame some characteristic feature of the picture. If severe straight lines and flat spaces predominate, these are easily reproduced in the plain unbroken surface of the frame. Sometimes the representation of carving in the picture can be repeated in the frame, or a certain treatment or pattern in the picture may be echoed by a suitable treatment of the frame. Often an appropriate beading or other molding may give the desired effect, see Fig. 74. Sometimes a touch of bright color, as that of the pirate's cap in Fig. 75, can be repeated with good ef-

fect in a fine line in the frame. In a word, the frame must be consistent with the color, *notan*, and general character of the picture.

In selecting the *wood* for a picture frame, it is well for a beginner to choose some soft wood like white pine or yellow poplar, until he is used to working the necessary tools and can make the joints well. These woods can be stained in a great variety of ways. Later it is better to make frames of hard wood. Oak is the most common. Maple is good for a "silver gray" effect to be obtained by staining with the water stain of that name. Mahogany is excellent where the color can be made to harmonize. Care must be taken not to select woods having such a prominent "grain" as to divert attention from the picture itself.

Concerning the materials to be used for mats,

"cover paper" is one of the most suitable. Ash gray will be found to tone well with a great variety of prints. Dull toned wall paper which has no pattern is often good. Grass-cloth comes in various colors, and this or raw silk stretched on cardboard makes a very effective setting especially for some Japanese prints.

Mounting the picture on the mat may be done in one of two ways: (1) The picture may be pasted directly on the mat. In most cases it will be found sufficient to fasten it in place by means of a



Fig. 69. Broad frame (pine), stained gray, oiled and rubbed with aluminium dust. Maxfield Parrish's "Prince Agib."



Fig. 70. A narrow dark frame with gray mat.

(2) An opening the size of the picture, may be cut in the mat, and the picture placed under this. This "cut out" has the advantage of giving a soft border line formed by the shadow of the mat.

II. *The Framing of a Japanese Print.* The picture chosen to be framed, according to the following directions, is a Japanese print, Fig. 76. The frame is to be perfectly plain. The size of the picture is $9\frac{1}{2}'' \times 13\frac{1}{2}''$. The frame is to be 1" wide and $\frac{3}{4}''$ thick. The materials required are as follows:

"White pine, $\frac{7}{8}'' \times 1'' \times 4'0''$ "

Picture backing, the same size as the picture, or mat, if the picture is to be mounted. The backing comes $\frac{1}{8}''$ thick.

- 1 sheet manilla paper.
- 1 light, picture glass, $9\frac{1}{2}'' \times 13\frac{1}{2}''$.
- 2 doz. brads, $\frac{7}{8}''$ No. 18.
- 2 screw eyes, Brooks No. 214, $\frac{1}{2}''$ (these have $\frac{1}{4}''$ hole).

Maple veneering, 6" square, if available.

line of paste, say $\frac{1}{8}''$ wide, on the top margin of the back of the picture. Before pasting the picture on the mat, locate it carefully and mark its location with fine pencil dots at the two upper corners. If the picture is to be mounted on the mat with paste all over the back, the mat must be of stiff enough material to hold its shape. If this method is used, the picture should first be dipped in water, the surface moisture dried off, paste applied uniformly over the back, the picture carefully laid in place and pressed under weight.



Fig. 71. Narrow black frame without mat.

"White pine is chosen for first frame because it is easiest to work accurately. A fine finishing frame is made of maple veneering, in order

Plane up the strips in two pieces, each long enough to make one long side and one short side of the frame. To determine the length



Fig. 72.
The blacks in the print balanced by the black in the frame.

of the members of a frame, add to the length of each dimension of the picture twice the width of the frame. In this case there will be needed two pieces about two feet long; thus, $9\frac{1}{2}$ " (width) + 2 " + $13\frac{1}{2}$ " (length) + 2 " = 23 ". Plane both pieces per-



Fig. 74. Japanese print framed with mat and narrow dark frame with bead.

fectly straight and the angles square, so that they will be 1 " wide and $\frac{3}{4}$ " thick. Test the straightness by sighting along the length, as in *Handwork in Wood*, Fig. 107. Be sure that the thickness and width of both pieces is uniform thruout. Unless the members are accurate the frame will not come together right. The



Fig. 73. Japanese prints framed with mats and narrow frames.

next step is to plow out a rabbet (or rebate) along one arris of each piece, to receive the glass and the picture and the backing. This should be done with the rabbet-plane (See *Handwork in Wood*, p. 79). This rabbet should be $\frac{3}{8}$ " wide and $\frac{1}{2}$ " deep.



Fig. 75. Broad frame in yellow, middle value, a little less brilliant than the sail. Maxfield Parrish's "The Pirates."



Fig. 76. Black frame to match the crow.

To use the rabbet-plane on a narrow piece of wood, it is first necessary to make a device like that shown in Fig. 77. On a piece X, say 2" or 3" wide and slightly longer than the long members of the frame, nail a strip about 1½" wide, ⅝" from one edge. Into the internal angle formed by these pieces and near one end, drive a small nail or

screw (A in Fig. 77) so that its head will project about ¼". This device when used is to be fastened on the bench between a bench-stop and the tail-vice-dog. Set the rabbet-plane so that the fence allows but ½" of the cutter to cut, and set the depth gage so that the plane can cut ⅜" deep. The cutter should be adjusted so as to cut as in an ordinary plane. Along the right arris of the sole is a removeable spur which scores the wood so that the cutter will not tear out but cut out the shavings clean. Before beginning to plane see that this spur is sharp and that the right corner of the cutter is in line with the arris of the sole. Now cut a trial rabbet on a waste

piece of wood, which has a straight edge. At the first stroke the spur will mark the width of the rabbet. Be careful to hold the plane flat, tilting it neither to the right nor to the left. The beginner in his effort to keep the fence close up to the edge is apt to tilt the plane to the right. This makes the spur cut in obliquely, as in Fig. 114, *Handwork in Wood*.

If the plane is not running true, stop planing and with a chisel trim out the recess clean and square and then proceed with the plane to the proper depth.

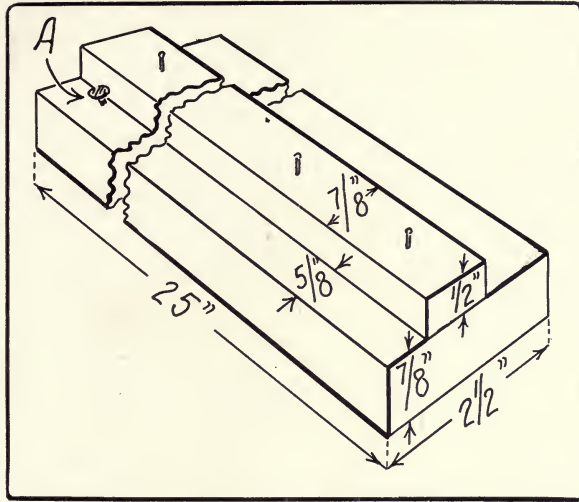

Fig. 77. Device for holding strips when rabbeting.

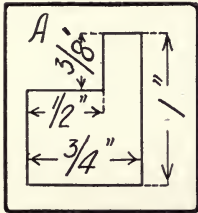

Fig. 78. End view of rabbeted strip.

After sufficient practice on waste pieces, plow the rabbets on the members of the frame, as in Fig. 78. Cut the 24" piece of stock in two, so as to make one long and one short member of the picture-frame. Fasten the device already made between a bench-stop and the dog in the tail-vice. Lay one member of the frame, narrow edge up, in this device, abutting against the nail. Plow out the rabbets in all four members. The next step is to cut the pieces to their proper lengths with a miter at each end. Fig. 79 shows the shape. The picture and glass are 9 1/2" x 13 1/2"; the frame is an inch wide and the rabbet 3/8" wide. Hence the

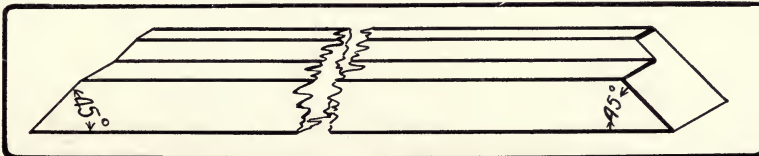

Fig. 79. Rabbeted and mitered member of picture-frame.

finished outside length of each member of the frame will be $\frac{5}{8}'' + \frac{5}{8}''$ or $1\frac{1}{4}''$ greater than the length (and width) of the picture and of the glass. Then allow $\frac{1}{8}''$ for play and the outside lengths of the long members of the frame will be $14\frac{7}{8}''$ ($13\frac{1}{2}'' + 1\frac{1}{4}'' + \frac{1}{8}''$) and the outside length of the short members $10\frac{7}{8}''$ ($9\frac{1}{2}'' + 1\frac{1}{4}'' + \frac{1}{8}''$).

Place one member face up in the miter box, that is, so that the rabbet is down and front, as in Fig. 80. With the back-saw cut off one end at an angle of 45 degrees, taking care that the side which is to be the outside of the frame is the longer, as in Fig. 79. Do this to one end of all the pieces. Now cut the other end of one piece in the

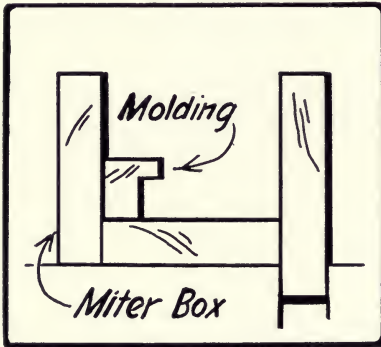

Fig. 80. Position of molding in miter-box.

same way, except that the saw is laid in the other 45° kerf of the miter-box. Cut the other member of equal length, using the first member as a measure, and repeat with the second pair. Now test these angles with the try-square from what will be the face side of the member when in the finished frame, and again test with the bevel set at 45 degrees from what will be the edge of the frame. (See above, page 52.) If necessary

trim on the bench-hook with the chisel (as above, page 52), or fasten the piece in the vise at an angle of 45 degrees and carefully plane toward the acute angle. This acute angle may be supported by a piece, X, also fastened in the vise, as in Fig. 81. Be sure the opposite members have equal lengths.

Now set up the picture-frame clamp (Fig. 53), adjusting the small parts to their proper holes, put the members in place, face up, and clamp the whole together in a handscrew. If any corners do not make a close joint, either the angles are not square or the opposite members are of unequal lengths. Make them right before you proceed.

When everything is ready, take the frame apart, put a little glue (see *Handwork in Wood*, p. 128) on all surfaces that are to join, and reclamp. Test the corners with a try-square, and if they are not right angles, adjust the handscrew by sliding one jaw sideways, one way or the other, until the angles come up right. Be sure that the faces are flush. Leave the frame in the vise for 6 hours to dry. When

the frame is taken out of the vise it should be handled carefully, for the joints still need to be reinforced. A common way to do this is with brads. If brads are used it is a safe precaution to make a hole before gluing with a bradawl thru one piece. Fasten the frame in the bench vise, so as to grip only one member at a time, and that vertically. Bore the hole and drive in the brad with great care.

A better reinforcement is by means of a spline or slip-feather (see *Handwork in Wood*, Fig. 268, No. 55). A convenient way to insert these is as follows: Get, if possible, some maple veneer $1/28$ " thick and cut it with

a knife into 8 pieces about $3/4$ " x 2 ". Fasten the frame in the vise diagonally, so that one corner will project, and with the back saw cut

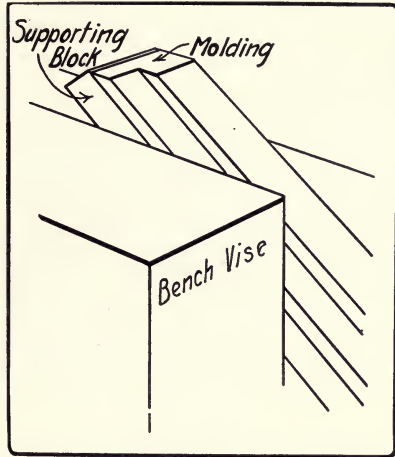

Fig. 81. Holding member of picture frame in vise to trim the miter.

two saw-kerfs, *A* and *B*, as in Fig. 82 and Fig. 83. The pieces of veneer should fit snugly into these kerfs. If the veneer is too thick, scrape or sandpaper it until it slips into the kerfs. If the veneer is too thin, use two pieces with glue between them for each kerf, thinning them if necessary.

Put glue on both sides of each piece of veneer, slip it into place and set the frame away to dry. When dry, cut off the superfluous veneer with a chisel or knife. With the plane, set very fine, smooth up any surfaces that need it, and sandpaper



Fig. 82. Sawing a kerf in which to insert a spline.

the whole. Sand off the sharpness of all arrises. Be very careful to leave no glue showing.

The next step is to stain the frame. As this frame is to be black, a simple method of staining it is to dissolve a little nigrosine in alcohol, and apply with a brush. Directions for a more penetrating black stain are to be found in *Handwork in Wood*, p. 211.

A good finish for picture-frames, which are handled but little, is wax. Apply as before directed. (See *Handwork in Wood*, p. 214).

Next cut the picture backing, so that the grain will run the short

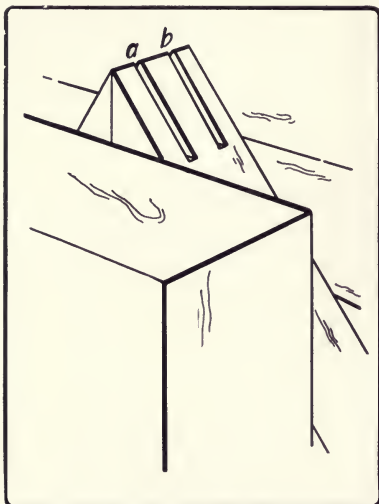

Fig. 83. Kerfs cut in corner of picture-frame to receive slip feathers.

way of the picture. It can be cut conveniently with a sharp knife and a straight edge. If necessary, cut on both sides and then break. Cut enough, and in as large pieces as possible, so as to cover the entire surface of the picture and mat as they lie in the frame. Next cut the glass to fit the frame, in this case $9\frac{1}{2}'' \times 13\frac{1}{2}''$. A glass cutter with hardened steel revolving disc can be bought for 10 cents. It is well to practice on a piece of waste glass. To cut the glass, proceed as follows: Make marks on the glass near the edges at the proper length. Lay a straight-

edge of wood one-eighth of an inch to the left of these marks (to allow for the distance of the cutting disc from the face of the glass cutter). Hold the glass cutter perpendicular, and with one firm stroke scratch the glass from edge to edge, Fig. 84. Be sure that the extreme edges are scratched. Then holding up the glass in the left hand, tap the underside of the glass near the near edge with the glass cutter, until the edge just cracks, Fig. 85. Now take hold of the portion of the glass to the right of the scratch between the thumb and first finger of the right hand, and with a slight pressure the glass will break clean along the line of the scratch, Fig. 86. If the scratch is so near the right edge that there is not room to hold it so, as described above, with a pair of pliers, carefully snap off the waste a little at a time, Fig. 87. Mark and cut the width in the same way.

Then wash the glass. An easy way to do this is with Bon Ami soap, rubbed on with a damp cloth, allowed to dry and polished off. Now lay the frame, face down, on the bench. Place the glass in position, the picture on top of it, and the picture back on top of that, fitting the pieces of it in place. Now nail all down in place, using



Fig. 84. Cutting glass. (Step 1.)



Fig. 85. Tapping under the scratch in the glass to start a crack. (Step 2.)

$\frac{7}{8}$ " brads, No. 18 as follows: Lay a brad flat down on the backing, point to the frame. Press it down with one finger, and tap the head with the hammer sliding on the backing. It will facilitate matters to let the frame rest against a bench-stop or a weight.

The next step is to paste a piece of Manilla paper over the back of the frame to keep out dust. Spread a thin film of liquid glue over the back of the frame, near the outer edge. Dampen one side of the Manilla paper with a wet cloth passed over it. Lay the dry side down



Fig. 86. Breaking the glass. (Step 3.)



Fig. 87. Breaking off a narrow piece of glass with the pliers.

on the back of the frame, as flat as possible. When it dries it will be stretched taut and the superfluous paper can be trimmed off with a sharp knife.

Next locate the screw-eyes in the back of the frame, say 2" from the top. Start a hole with a brad awl, and screw home the screw-

eyes, (Brooks No. 214½"). Stretch a flexible wire straight between the screw-eyes, twisting it back around itself, and the frame is done.

III. *Additional Suggestions for Frames.* The frame just described is the plainest and simplest one possible. With but little difficulty, however, before cutting the miters, it may be considerably

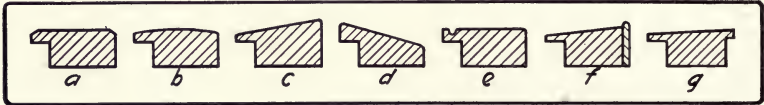

Fig. 88. Sections of moldings for picture-frames.

embellished. For examples see Fig. 88. Chamfers can be planed on the front arrises of the members of the frame, as at *a*, or the front surface may be rounded, as at *b*. Instead of making the frame flat, it can be bevelled in or out, as at *c* and *d*. This should be done with the plane after the rabbet is plowed. A thin line may be grooved near the inner edge so as to make it, in cross-section like *e*. This is done by means of a veining tool after the frame is joined together. Draw the line to be grooved carefully with a pencil. Lay a straight edge along this line and with the veining tool running along the straight edge, cut out the groove. Take care to keep the depth as even as possible. See Fig. 176, p. 130.

A considerable variety of beads and flutings may be made by means of the Universal Hand Bearer, (Stanley's No. 66) a tool which costs about 75c. See Fig. 89.

More complicated moldings, such as that shown in Fig. 90 may be made with a cabinet scraper, filed to the desired shape, and clamped between a pair of blocks of wood by means of screws as shown in Fig. 91. The two edges *A* and *B* serve as guides sliding along both edges of the molding.

A nosing may be added to the outside of a molding, as in Fig. 88, *f*, as follows:

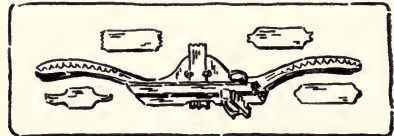

Fig. 89. Hand bearer with cutters.

Prepare thin strips of wood, say ⅛" thick and ⅛" wider than the frame is thick. Round off one edge as follows:—Fasten the jack plane upside down in the vise, hold the strip at an angle and pull it over the plane cutter so as to plane off an arris, Fig. 92. Do this for both the arrises on one narrow edge. Finish it round with sand-

paper. Or better, round this with the hand beader, Fig. 89, or the cornering tool (*Handwork in Wood*, Fig. 124.) Drive thru these strips several little brads, so that the points project slightly and fit them exactly in place on the outside of the members of the frame. Prepare several handscrews so as to clamp these strips to the mem-



Fig. 90. A frame with delicate moldings, in keeping with the delicate handling of the painting. See also Fig. 91

bers, taking care to protect the inner edges of the members by waste strips of wood, Fig. 93. When all is ready glue the strips in place, clamping them firmly with the handscrews. The brads will keep them from slipping out of place. Wipe off superfluous glue carefully with a rag moistened with very hot water. When dry, remove the handscrews and pull out the brads. The brad holes can be closed up by wetting them and placing a hot iron on them. This, by the way, is a good method of closing up all surface bruises where the fibers themselves are not broken. Finally cut the miters and proceed as before.

A frame can be made to look lighter by plowing out a narrow rabbet on the outer edges of the members as in Fig. 88, *g*. This can best be done before the miters are cut, but it may be done after as-

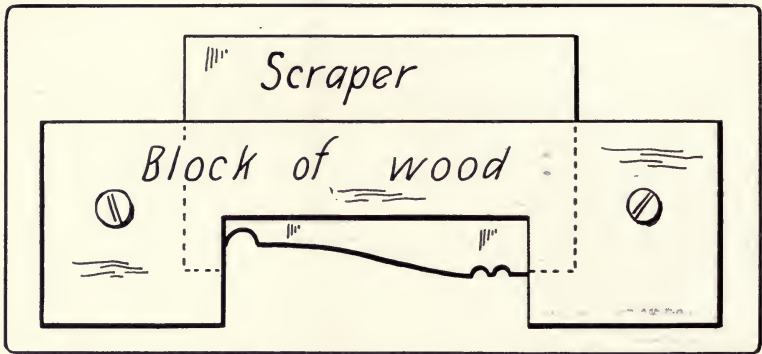

Fig. 91. Improved molding scraper.

sembling. In this case, before rabbeting take care to trim off with a chisel the arrises at the corners of the frame so that they will not splinter off. See above, p. 44, Fig. 26.

Of essentially the same construction as a picture-frame, are the glass bottomed trays, shown in Fig. 94. They are made with mitered

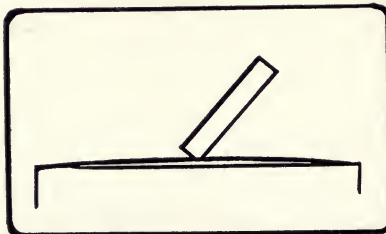

Fig. 92. Method of planing off chamfer on a thin piece of wood.

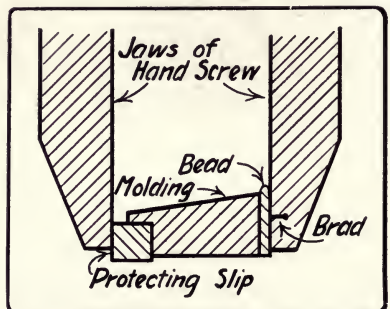

Fig. 93. Method of clamping nosing on outside of picture molding.

molding, and the joints are mitered with a slip-feather inserted. A Japanese stencil is laid between the two sheets of glass, fastened into the rabbet with thin strips tacked in place.



Fig. 94. Glass bottomed trays made with mitered frames.

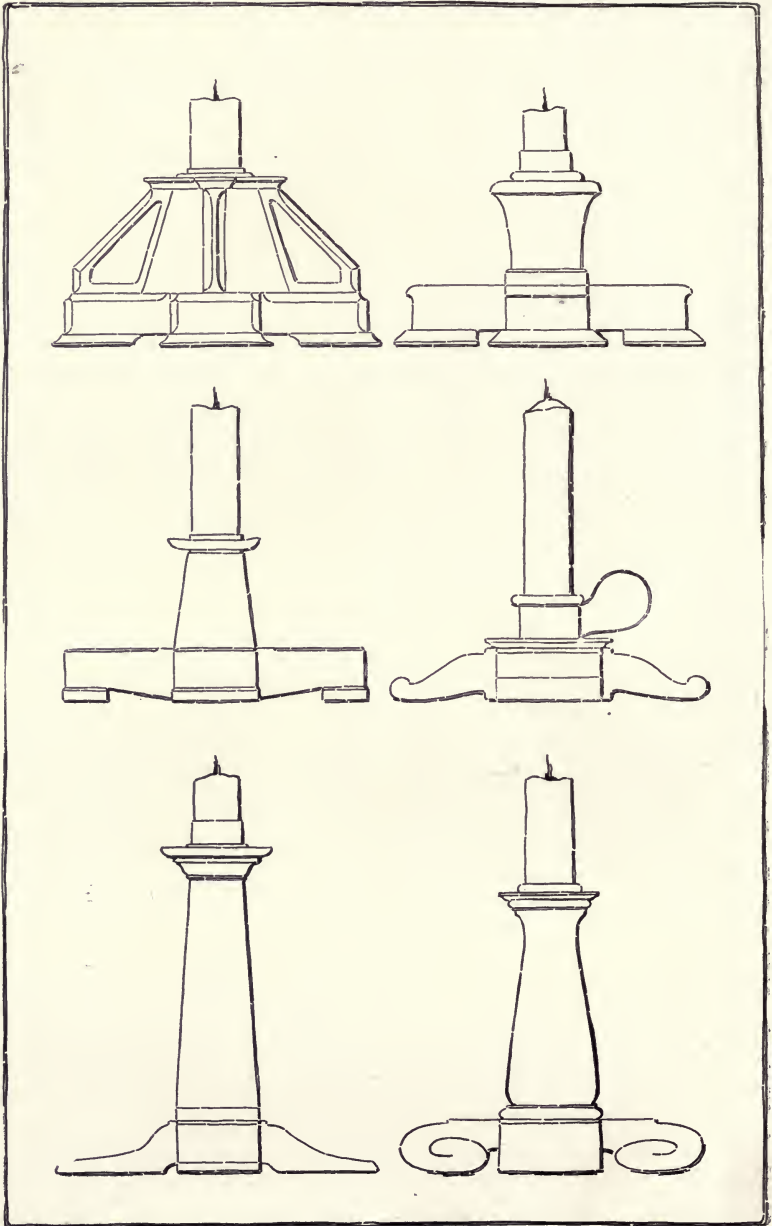

Fig. 95. Candlesticks.

CHAPTER VII

THE CANDLESTICK

Altho the essential features of this project set fixed limitations to its design, yet a great variety of forms and embellishments are possible; see Fig. 95. The success of the design depends, primarily, on the harmonious unity of the parts. If the design be good, the piece is worth much painstaking labor.

This project consists of two parts, the copper socket and pan, and the wooden base supporting these.

I. *The essential features* to be fixed are:

1. The size of the candle to be used. (Common sizes are $\frac{3}{4}$ " or $1\frac{1}{8}$ ".) This determines the diameter of the socket.

2. The pan, of such a shape as to catch the drip well. This is to be soldered to the socket.

3. A base, large enough to be stable. The construction suggested for this base is a cross-lap joint.

4. A convenient means of handling. This may be either a loop for the forefinger, Fig. 96, or a column to be grasped, Fig. 97.

5. The kind of wood. The piece does not require much material and is worth while making in wood of a good species and quality. Mahogany, black walnut, and sweet gum are not difficult to work, can be finished handsomely and their colors harmonize well with the copper parts.

II. *The refinement of the proportions.* The candlestick without the column may well be quite small, each member of the joint being not more than 4" or 5" long and $1\frac{1}{2}$ " or more wide.

With a column, Nos. 2, 4, 6, 8, Fig. 97, the size of the base will naturally increase; the higher the column, the broader the base. The candlestick must seem as well as be stable.

If feet are added, Nos. 2, 7, Fig. 97, the effect of stability will be increased.

III. *Embellishments.* These include modifications in outlines by modeling, Fig. 97, No. 5, chamfering, Fig. 97, No. 8, coving Fig. 98,

No. 8, beading, Fig. 98, No. 1, or even carving, Fig. 96. Suggestions for such treatment are also given in other pictures. Whatever is done, the treatment should be harmonious thruout.



1 2 3
Fig. 96. Low candlesticks.

An appearance of lightness may be given to the column by constructing it as in Fig. 99.

The best finish for a candlestick that may be frequently handled and is liable to be smeared with wax or tallow, is boiled linseed oil, thoroly rubbed. If made of mahogany, the color may be darkened with bichromate of potash. See below, p. 92.



Fig. 97. Column candlesticks.

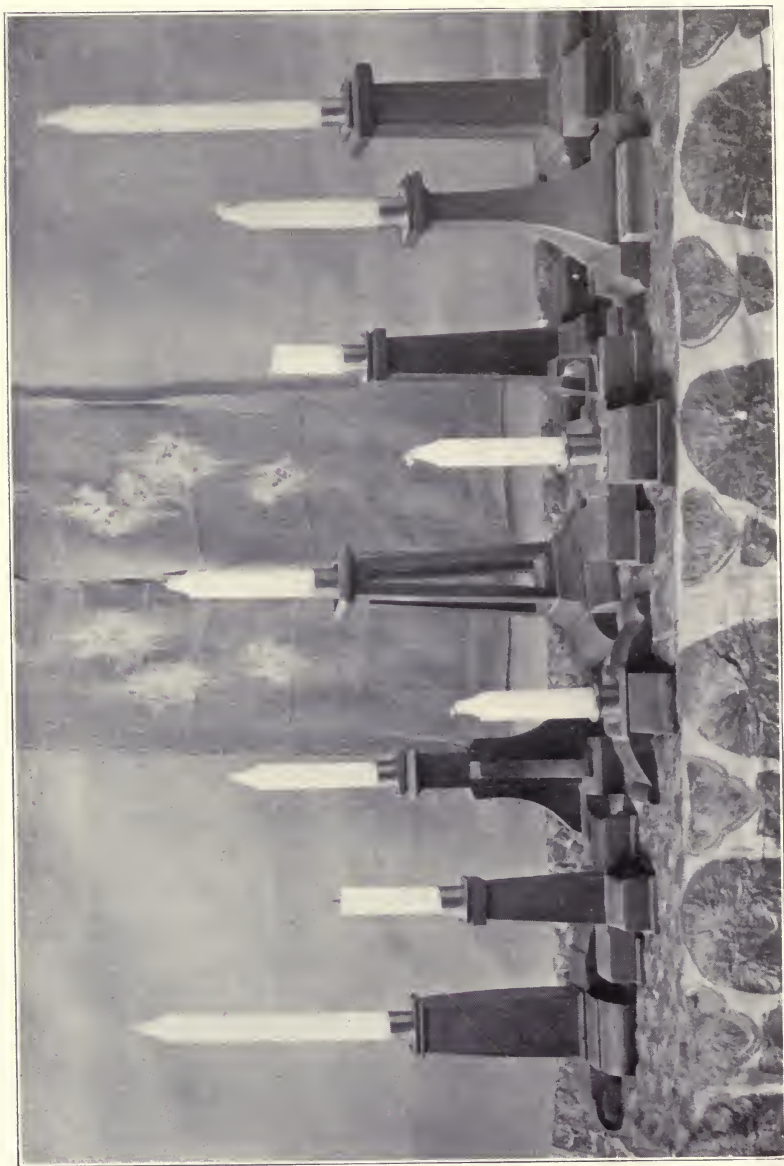

1 2 3 4 5 6 7 8 9

Fig. 98. Candlesticks, variously designed.

IV. *Directions for making cross-lap joint.* In order not to waste good wood in learning how to make the cross-lap joint, it is well to make first a practice joint of pine or other soft wood.

Select a piece of straight grained pine, and carefully plane it to the size, $\frac{3}{4}$ "x $1\frac{5}{8}$ "x11", finishing all surfaces. For the order of plan-



Fig. 99. Column of candlestick lightened.

ing surfaces, (see *Handwork in Wood*, page 72.) Be careful that the piece is of uniform width and thickness thruout, and finish both ends clean and square. Mark a point 5" from each end of the piece, score with a sharp knife all around the piece at both these points, cut a little groove on the waste side of the lines, on one broad surface, (see *Handwork in Wood*, page 66, and Fig. 91), saw off the waste and trim the ends with the block-plane. Now make the half-lap joint as described in *Handwork in Wood*, page 155.

Directions follow for making the candlestick shown in Fig. 100.

The materials required are, mahogany or black walnut:

- A. 1 piece, $\frac{7}{8}$ " x $1\frac{3}{4}$ " x 11.
 - B. 1 piece, $\frac{3}{8}$ " x $2\frac{1}{8}$ " x $8\frac{1}{2}$ ".
 - C. 1 piece, $1\frac{3}{4}$ " x $1\frac{3}{4}$ " x 3".
- Brads $\frac{3}{4}$ " No. 18.
Copper, gage No. 20, 1 piece $1\frac{5}{8}$ " x $1\frac{5}{8}$ ".
One piece 1" x 3".

I. *The Base.* When the practice joint has been satisfactorily made, proceed in the same way with the more valuable wood for the base.

It is better not to sandpaper the members until they are glued together, as an otherwise tight joint may thus be made loose. Put a

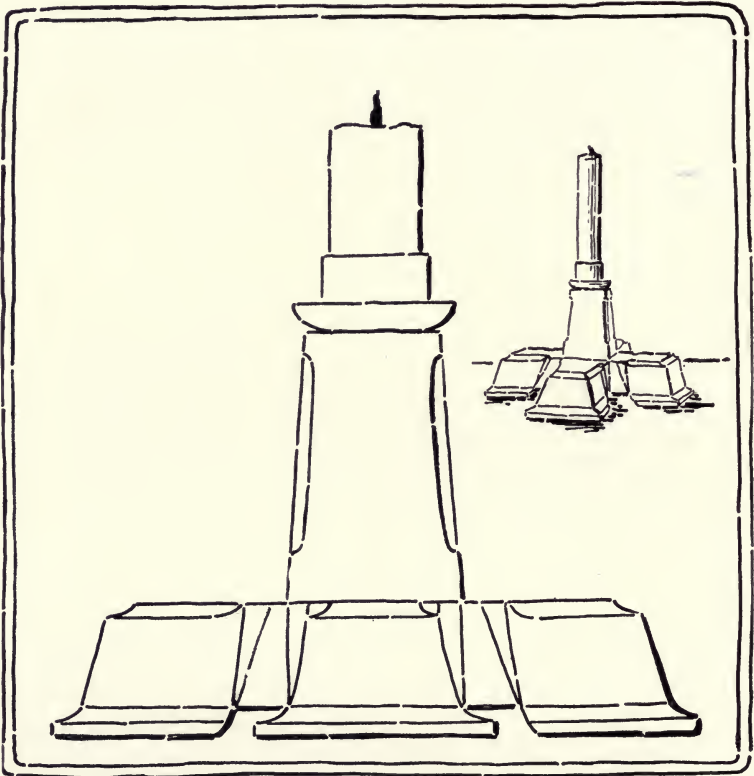

Fig. 100. Candlestick.

little glue in the joint and clamp tight in the bench vise or in a handscrew, protecting the surfaces by means of pieces of soft wood. When dry, clean up and dress the faces flush.

With a gouge of the correct curve, carve out the coves along the upper arrises. Sandpaper.

II. *The Column.* If there is to be a column, make that next. If you have no wood thick enough, ($1\frac{5}{8}$ ") to make it of one piece, face off a piece of $\frac{7}{8}$ " stock long enough so that it can be cut in two, and the two pieces glued together so as to make one. Be very careful to make this a close joint, and to put them together so as to have the grain running in the same direction when glued together, see Fig. 101. Dress up this piece true and square,

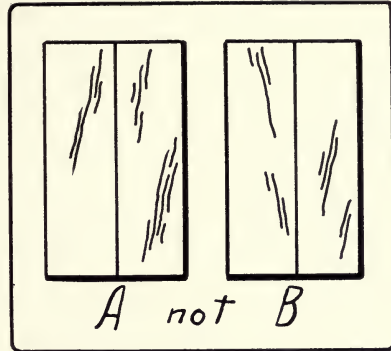

Fig. 101. The way the grain should and should not run in jointed column of candlestick.

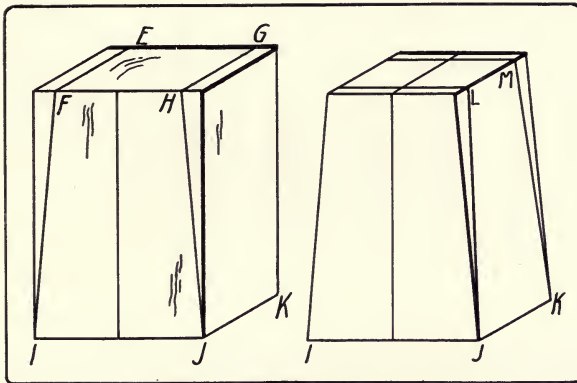

Fig. 102. Lay-out of column for candlestick.

Clamp the piece on the bench between the bench-stop and the vise-dog, and plane down to these ruled lines. Plane off from what is to be the narrow end first, so as to get a surface parallel to the desired line as soon as possible. When these two sides are correctly tapered, lay out the other two sides in a similar way, drawing lines at *L J* and *M K*, Fig. 102, and plane to shape. If for lack of a tail-vise, it is necessary

$1\frac{5}{8}$ " x $1\frac{5}{8}$ " x 3". To taper the column proceed as follows: With the marking-gage, gage lines on the upper end as on Fig. 102, *E F* and *G H*. On two opposite sides rule fine pencil lines, as *F I* and *H J*.

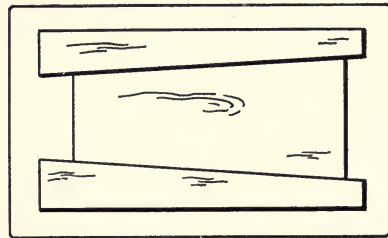

Fig. 103. Wedged-shaped pieces make it possible to hold the tapered piece in the vise.

to hold this piece, already tapered on two sides, sidewise in the vise, two blocks of soft wood need to be made first, having a similar taper, and between these the column can be held without injury in the vise as in Fig. 103. These blocks will also be useful in holding the column while adding chamfers or other embellishments.

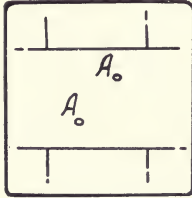

Fig. 104. Drill holes in pedestal for brads.

The column is now to be jointed to the pedestal. The simplest way to do this is with a butt dowel joint. Bore with a number 40 twist drill two holes in the pedestal as at *A, A*, Fig. 104. Put a touch of thin glue on the large end of the column, fit it exactly in place and drive two brads thru the holes *A, A*, Fig. 104, letting the heads project slightly. If the joint is not close, clamp the base tightly to the column with a handscrew. When dry, remove the handscrew, gently pull out one brad, bore a $5/16''$ hole in its place, work some glue into the hole and drive in a dowel. Repeat with the other brad.

Trim off the ends of the dowels. Or the column may be mortised into the base, making what is called a "three-way joint." For directions, see *Handwork in Wood*, pp. 160-161.



Fig. 105. Cutting copper with snips.

III. *The Capital*. One piece, $7/8'' \times 1/4'' 1 1/4''$. If this is to be

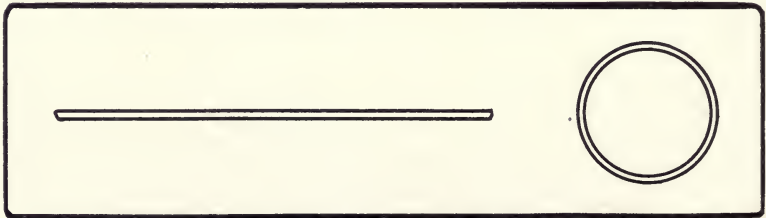

Fig. 106. Ends of strip for socket beveled so as to butt well.

simply a flat rectangular piece of wood, dress it to the proper size and sandpaper it and dowel it or screw it to the column with two long

screws ($1\frac{1}{2}$ " , No. 4). See *Handwork in Wood*, p. 126. If the socket and pan are to be made as in Fig. 113, the capital should have in it a hole into which the socket may fit. For a $\frac{3}{4}$ " candlestick, this hole should be $\frac{7}{8}$ " in diameter. Take for the capital a piece of wood several inches long. The extra length makes it easier to plane, and lessens the danger of splitting when the hole is bored. Plane it with square edges to the proper width and thickness and bore a $\frac{7}{8}$ " hole into it, gripping it

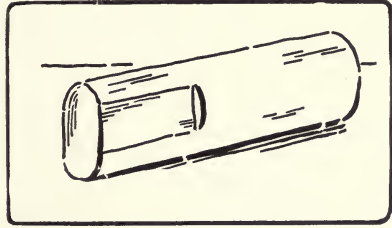

Fig. 107. Stake for hammering copper socket.

sidewise in the vise. This also is to prevent splitting it. If the piece is $\frac{7}{8}$ " thick the hole should be about $\frac{5}{8}$ " deep, bored with a Foerstner bit. Next saw off to the proper length and finish the ends of the piece neatly with the block-plane. It may be glued and screwed securely to the column, driving the screws thru what wood is left at the bottom of the hole.



Fig. 108. Hammering a strip into a cylinder.

Next saw off to the proper length and finish the ends of the piece neatly with the block-plane. It may be glued and screwed securely to the column, driving the screws thru what wood is left at the bottom of the hole.

IV. *The Feet.* Four pieces $\frac{3}{8}$ " x 2" x 2". Plane up one strip of wood to the desired thickness; in this case $\frac{3}{8}$ " thick, 2" wide and $8\frac{1}{2}$ " long, and if the arrises are chamfered or otherwise shaped, this should also be done before cutting up into small pieces. After cutting up, finish what are to be the outside ends of each piece harmoniously with their sides. That is, have the shape continuous around each foot.

To fasten on the feet, drive from the underside of each foot two or three small brads, $\frac{3}{4}$ " , No. 18, until the points just prick thru.

Put a little glue in the middle of the upper surface of each foot, adjust and press it to its proper place, and drive the brads home. The piece is now ready to be cleaned up and finished. After carefully sandpapering, wet the surface with water in order to "raise the grain," and when dry sandpaper once more. Then when the water stain is applied, the grain will not rise again.

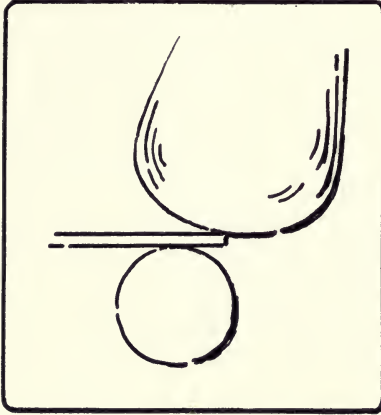

Fig. 109. Method of hammering a cylinder out of a strip.

If the piece is made of mahogany, it may be darkened with a solution of bichromate of potash crystals, to be obtained at any druggist's. Make a saturate solution. It dissolves readily in hot water. If this is applied full strength, the color of the wood will be a dark brownish red. A good proportion is one

part of the saturate solution to three parts of water. Apply with a brush and wipe off the surface at once with cotton waste. If, after a little exposure to the light, this does not appear dark enough, another coat may be added.

Rub down the surface with steel wool. A simple and effective method of finishing this piece is to oil it with a mixture of boiled linseed oil, one part, and turpentine, two parts. This should be wiped dry and rubbed hard many times with a little of the oil on a rag.

If more gloss is desired, give the piece a coat of wax. (See *Handwork in Wood*, page 214.)

V. *The Metalwork.* For the socket and pan for the candlestick, sheet copper, gage No. 20, is needed. To get the proper size for the socket or cylinder, wrap a piece of paper around the candle to get its circumference, and add to this four times the thickness of the copper. With the snips, Fig. 105, cut a piece of copper this length, and as wide as the depth of the socket, say 1". Hammer the piece flat with the mallet on the bench. File the long edges straight and parallel and square, and the end edges square to the side edges, but

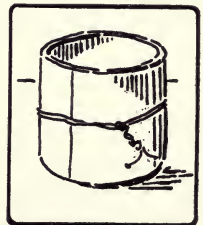

Fig. 110. Cylinder wired to hold joint in place.

with a slight bevel toward what is to be the inside of the socket, so that when the piece is curved into cylindrical shape, the ends will butt well, as in Fig. 106.

To hammer this strip into shape, you need a cylinder of iron $\frac{5}{8}$ " thick with flat surfaces filed at one end, as in Fig. 107, so that it can be held firmly in the iron vise. A piece of gas pipe, with one end crushed together will do. For the hammering, use a small wooden or horn mallet, so as not to mar the surface of the copper. See Fig. 108.

To curve the copper strip on this improvised anvil, hold one end of it so that it projects slightly to one side of the anvil, (cylinder) and hit this projecting end with the mallet. Push out the copper a little more and hammer again. See Figs. 108 and 109. Continue this process until the strip becomes a cylinder. If any part has been

bent too much lay that part directly on the anvil and hit there. If any part needs bending more to make the circle perfect, lay that part on the anvil and hit just off the point of contact. Be particularly careful to curve the extreme ends, and see that they butt exactly thruout, in order that they may be soldered well later.

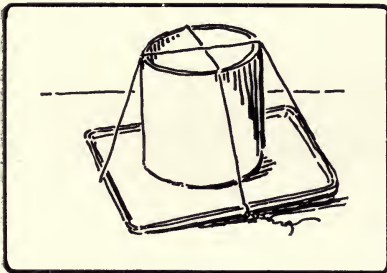

Fig. 112. Socket and pan wired together for soldering.

ing salt, (Yager's) to be dissolved in water according to the directions given, or may be made by digesting zinc in muriatic acid.)

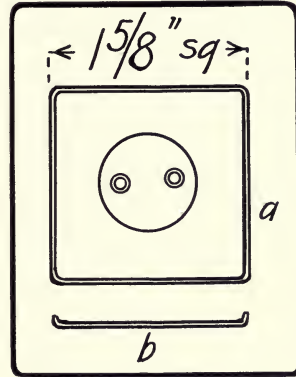

Fig. 111. Pan for candlestick.

Now wrap and twist a piece of binding wire, Gage No. 24, to hold the butted edges tight together, Fig. 110, and solder the joint. *A simple way to do this is as follows: Touch the joint thruout its length with a little stick dipped in soldering fluid. (This may be bought prepared at a hardware store, either in fluid form, or as solder-

*See Simple Soldering, by Edw. Thatcher. Pub. by Spon & Chamberlain.

On the joint lay a small piece, say $\frac{1}{4}$ ", of wire solder. By means of a pair of pliers, hold the cylinder, joint down, over the gas flame of a bunsen burner or gas stove, till the solder melts. With a small stick wipe the solder back and forth in the joint and set aside to cool.

To make the pan proceed as follows: With the snips cut out a square of copper, $1\frac{5}{8}$ " square, snip off the sharp corners, and file the edges square and smooth. See Fig. 111. Use fine sandpaper or emery cloth to polish up the surface. Turn up the edges slightly all around as follows: Set a bar of iron, say $\frac{1}{4}$ " thick and $\frac{3}{4}$ " wide, upright in the iron vise. File the end so that it will be slightly

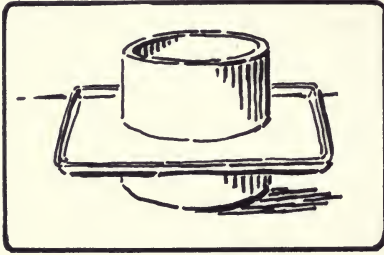

Fig. 113. Pan encircling socket.

rounded and smooth, and with the horn hammer, hammer the edges over this "stake", as it is called. See Fig. 111 *b* for the cross-section of the pan. Be particularly careful to make the corners all alike, and to keep the bottom of the pan flat. If it becomes concave turn it upside down on a flat surface and tap the bottom gently with the horn hammer.

With a twist-drill, held in a hand-drill, (see *Handwork in Wood*, p. 106, Fig. 187,) bore and countersink two small holes in the bottom of the pan to fit $\frac{3}{8}$ " No. 2 screws, as in Fig. 111. These holes should be inside a circle $\frac{3}{4}$ " in diameter at the center of the pan, so as to be included in the socket.

Scrape the surface to be soldered together bright and clean, and tie the socket already made, firmly to the pan with binding wire as in Fig. 112. Cover the joint of the socket with rouge made into paste with water. This is to prevent its unsoldering when the pan is heated.

Apply soldering fluid to the joint from the inside of the socket, lay a couple of pieces of wire solder next the joint, hold the pan and socket over the gas flame just until the solder melts, and then quickly wipe the melted solder into place, as before. If the joint is close and

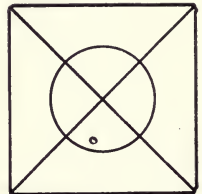

Fig. 114 Lay-out for pan shown in Fig. 113.

the soldering fluid is carefully applied, the solder will hardly show on the outside. If it does, it can be cut off with a sharp knife.

Polish the surface with a fine emery cloth and then with a cloth smeared with tripoli, or on a buffing wheel, if that is available. To darken, dip in a solution of liver of sulphur, (potassium sulphide) and coat with turpentine.

A slightly more difficult form of socket and pan is shown in Fig. 113. For this form, after the pan has been shaped, cut a hole in it thus:

Find the exact center of the square by drawing the diagonals, and with the compasses draw a circle just the outside size of the socket, as in Fig. 114. Drill a hole somewhere within this circle, and with a coping-saw, Fig. 115, saw out the circle, sawing always within the line. While

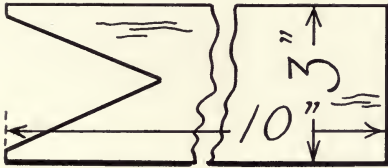

Fig. 116. Wood notched to hold copper while sawing.

sawing, the pan may be conveniently held over the notch of a piece of wood cut in the shape shown in Fig. 116. Then file the hole to exactly fit the socket. Tie the two in place with iron wire, and solder from the under side. This socket may also have a bottom soldered to it, but this is not absolutely necessary.

The rim of the socket may be embellished by having a ring of copper wire ($\frac{1}{8}$ " thick) soldered to it as shown in cross-section in Fig.

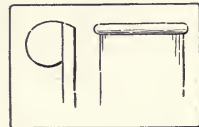

Fig. 117. Wire ring around edge of cup.

117. The photographs given show a variety of designs for the pans. An easy way to hammer out the shape shown in Fig. 118, Nos. 1 and 3, is to gouge out of a block of maple a mold of the desired shape, tack down with carpet tacks the copper over this mold, as in Fig. 119

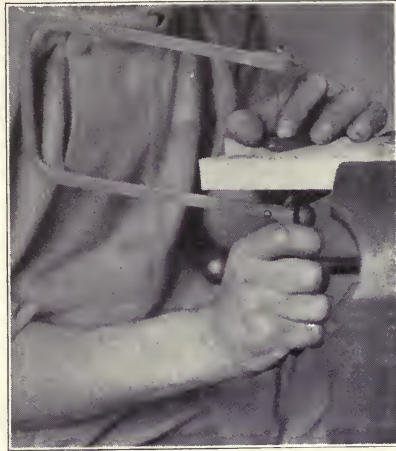

Fig. 115. Using a coping-saw.

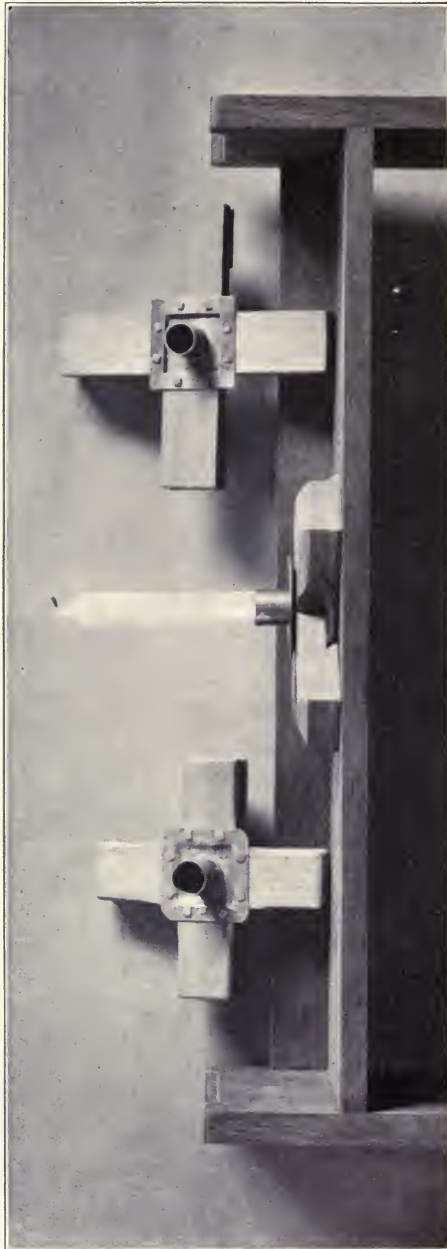

Fig. 118 Low candlesticks.

and hammer it into the mold with the peen of the horn hammer. The depression thus made may be set into a corresponding depression cut in the wood of the candlestick and the whole fastened in place with copper tacks, the heads of which are filed square.

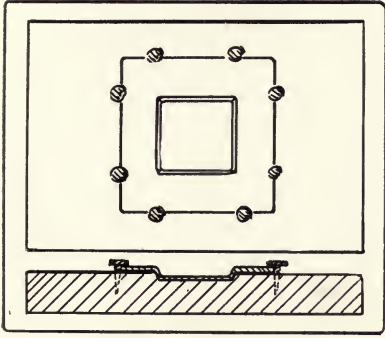

Fig. 119. Rim pan tacked down over mold.

In some of the designs copper handles are shown. See Fig. 96. They are shaped in a way similar to that of the cups, and in some cases are screwed to the wood under the rim of the saucer, and in some cases soldered to the socket and pan.

Other simple projects involving the cross-lap joint are the flowerpot stands, shown in Fig. 120, having either one or two joints.



Fig. 120. Flowerpot-stands, made with half-lap joint.

The same joint is used in the taboret, Chapter VIII.



Fig. 121. Smoking-table.

CHAPTER VIII

TABORET

In order to keep the construction of this project as simple as possible, the limitations imposed are that the frame shall consist of two cross-lap joints made of boards under one inch thickness, to which are butted and doweled the legs, having approximately the same thickness. To this frame is attached a board top.

Even under these limitations, great variety is possible, as shown in the accompanying photographs. The size may vary from a tea or smoking table, Fig. 121 or 123, to a low stand, a few inches in height, Fig. 122.

The wood suggested is chestnut or cypress, because of their easy working qualities, but soft mahogany or baywood may be used with great success.

The refinement of proportions includes the consideration of such items as the width and thickness of the legs in proportion to their height, the disposition of the stretchers, whether they shall be on edge or flat, and where located, the amount of projection of the top beyond the legs and the shape of the legs and of the top.

The attractiveness of the project depends largely upon its good proportions and upon the beauty of the grain of the wood. The rounding of the dowels into projecting buttons, plainly indicating



Fig. 122. Low taboret.



Fig. 123. Tea-table.

the structure, the use of chamfers, or coves, and the addition of feet, as in Figs. 121 and 123 are suggested. The color depends largely upon its intended environment. Chestnut turns to a beautiful brown when it is exposed to ammonia fumes and then oiled.

Since a taboret is to be used to hold a potted plant, the finish should be such as will stand moisture best. That is boiled linseed oil.

The process of making the typical form, Fig 124, will be described first, and the changes later. The drawing with dimensions is shown in Fig. 125. Either chestnut or cypress is



Fig. 124. Simple type form of taboret.

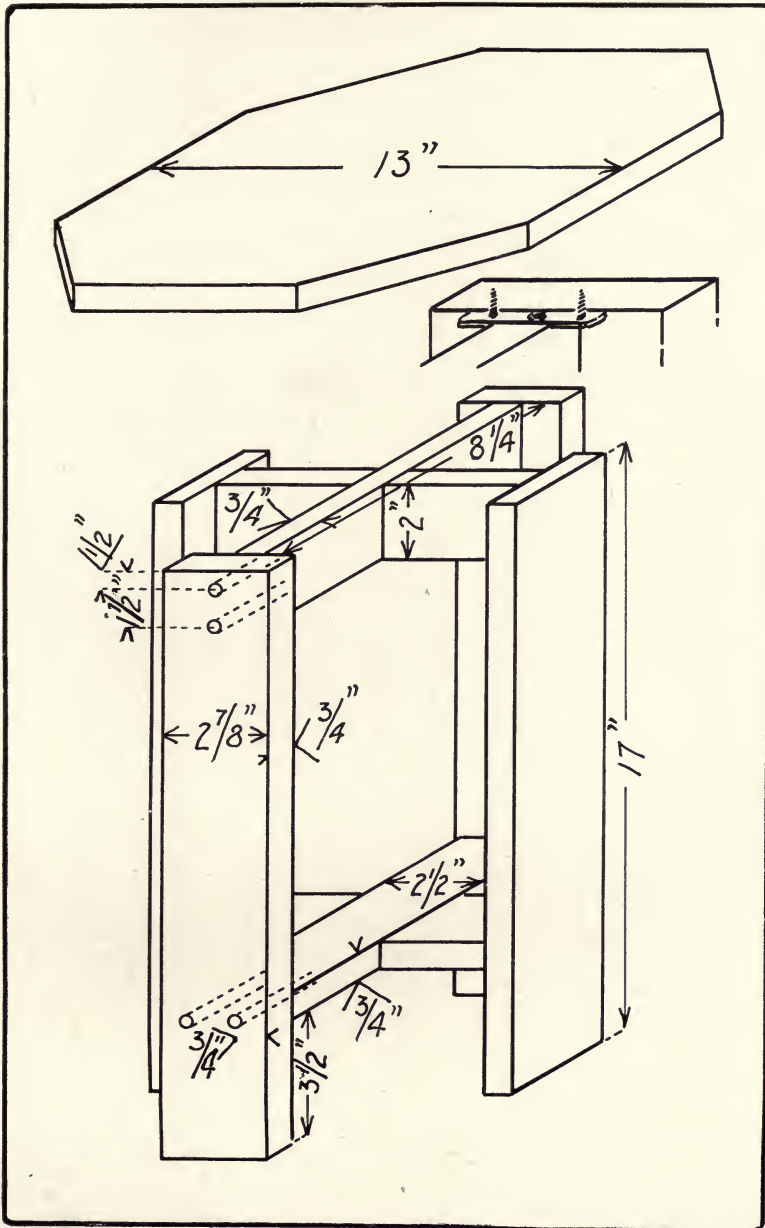

Fig. 125. Taboret.

good for this project. Chestnut has rather a coarse texture, and is liable to split along the annual rings on account of the presence of many pores. Cypress is likely to contain many fine checks, produced in seasoning.

Choose if possible wood with a pleasing grain, especially for the top. The materials necessary are as follows:

- A. 4 pieces $\frac{3}{4}$ " x $2\frac{7}{8}$ " x 17".
 - B. 2 pieces $\frac{3}{4}$ " x 2" x $8\frac{1}{2}$ ".
 - C. 2 pieces $\frac{3}{4}$ " x $2\frac{1}{2}$ " x $8\frac{1}{2}$ ".
 - D. 1 piece $\frac{3}{4}$ " x 13" x 13". This may be made of two pieces jointed together, as shown later.
- 16 dowel-pins $\frac{5}{16}$ " x $1\frac{3}{4}$ ".
 4 brass mending straps $\frac{1}{2}$ " x 2", No. 60.
 12 screws $\frac{5}{8}$ " No. 4.
 16 brads No. 13, $2\frac{1}{2}$ ", No. 12.

Plane up four pieces, A, to proper size. In order to true the ends exactly, all four pieces may be clamped together in a handscrew and the bench vise, and block-planed at one time. First plane one set of ends, then reverse and plane the other set. Great pains must be taken to keep the whole block square, or all the pieces will not be of the same length.

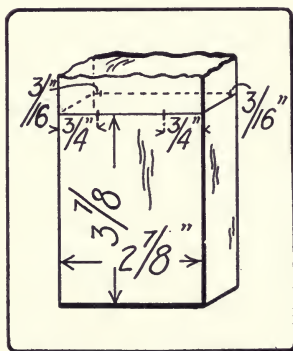

Fig. 126. Lay-out of joint of lower stretcher with leg.

Plane up the stretchers, B and C, in a similar way, all four to exactly the same length. Make a cross-lap joint with pieces B and with pieces C according to directions given in *Handwork in Wood*, p. 155.

The difference between the joints in pieces B and pieces C is that in B the edges lap, whereas in C the faces lap. With this difference however the process of making is the same, the flat joint being slightly more difficult.

Glue these joints together and leave in a handscrew to set, testing the joint to see that it is a perfect right angle.

To fit the lower stretchers to the legs proceed thus: All around the legs, $3\frac{7}{8}$ " from the bottom of each, draw a fine pencil line, and on the inside of the legs, at $\frac{3}{16}$ " from the edges, mark points as in Fig. 126. On this line *on the outside* of all the legs place a mark

$\frac{3}{4}$ " from each edge to indicate the centers of the holes for the dowel-pins, with which the joints are to be fastened together. See Fig. 126. Mark center line on the edges of stretchers *C* at the ends, as at *A B*, Fig. 127.

To fit the upper stretchers *B* to the legs, proceed as follows: Draw a fine pencil line across the center of the top ends of the legs and continue this line down both outside and inside of the legs for $2\frac{1}{2}$ " from the top, as in *C D E*, Fig. 128. On this line on the outside of the leg indicate points *A B*, $\frac{1}{2}$ " and $1\frac{1}{2}$ " from the top for centers of holes for the dowel-pins. Mark center lines on the edges of the stretchers *B* at the ends; *C D*, as in Fig. 127.

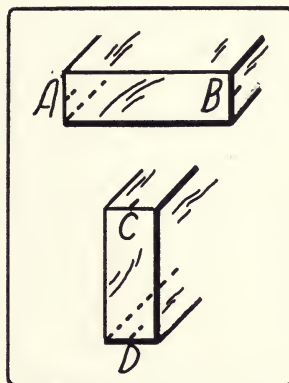

Fig. 127. Center lines *AB* and *CD* marked on stretchers.

If the legs are to be shaped, as in Fig. 129 the following method may be used:

Clamp two legs side by side and bore a $\frac{5}{8}$ " hole at the proper point *A*, in Fig. 130, setting the spur of the bit directly in the crack between the two legs. Bore half-way through, reverse, and finish boring. Repeat on all the edges. The surplus wood may then be worked out with a saw and spokeshave or small plane.

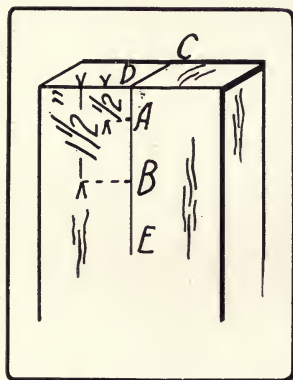

Fig. 128. Lay-out of joint of upper stretcher with leg.

Next prepare 16 dowel-pins, each $1\frac{3}{4}$ " long and $\frac{5}{16}$ " diameter. When there are a number of pins to cut off, it saves time to use a miter-box, fastening a stop at the proper distance, ($1\frac{3}{4}$ " in this case) from the kerf, and so being able to cut each one off without stopping to measure, Fig. 131.

Next test the size of the dowel-pins in a $\frac{5}{16}$ " hole bored in a piece of waste wood. The fit should be snug. If the dowel-pins are too large to drive in easily, reduce their size by driving them with a mallet, not a hammer, thru the $\frac{5}{16}$ " hole in the dowel-plate, Fig. 132.

Point one end of each pin with a dowel-pointer, (*Handwork in Wood*, p. 83), to insure their entering the holes readily and round off the other end into a button shape as in Fig. 133. This may be done conveniently with a sharp knife and sandpaper, or better still, of course, on a lathe.



Fig. 129. Taboret with shaped legs.

Next the legs and stretchers are assembled as follows: With the hand-drill (*Handwork in Wood*, p.106, Fig. 187), holding a No. 40 twist-drill which is slightly smaller than the brad to be used ($2\frac{1}{2}$ " No. 12), bore holes thru all the legs at the points indicated for the dowel-pins, four in each leg. Take especial pains to bore at right angles to the surface, because these holes will afterward determine the direc-

tion of the holes for the dowels. Drive the brads ($2\frac{1}{2}$ " No. 12) into these holes so that their points just come thru. Start the brads ($2\frac{1}{2}$ " No. 12) into these holes, and placing each leg at its proper place on each stretcher, drive the nails into the stretchers about $\frac{1}{4}$ " and take apart. The dents thus made by the nails in the ends of the stretchers will make it easy to locate them in place when gluing up.

Have ready two carpenter's bar clamps, (*Handwork in Wood*, p. 103), two large (Aldrich's No. 5, 18") handscrews (*Handwork in Wood*, p. 101), and eight blocks of soft wood, three or four inches long and just large enough to fit between each pair of nails.

If no clamps or handscrews are available, substitutes may be made thus: Cut two boards and two wedges, as in Fig. 134. These improvised clamps can be hooked over the blocks which are placed between the nails, and then the wedges driven in to draw the joints up tight.

Put a little hot glue on the end of a stretcher, B, locate it by means of the marks already made in it by the nails in the leg, and drive in the nails, leaving the head of the brad projecting half an inch, so that it can be easily withdrawn later. In the same way nail stretcher C in place to the same leg. Then nail the opposite leg to the other ends of these two stretchers. Proceed in the same way with the other two legs, working as speedily as accuracy will permit in order that the glue may not set before the clamps are applied. The clamps are applied to these joints as shown in Fig. 135. Test the interior angles to see that they are square.

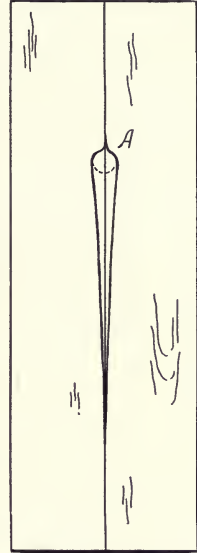

Fig. 130. Method of shaping legs.

If not, adjust the clamps on a slight diagonal, so as to pull the piece into shape as in the diagram Fig. 136, in which the distortion is exaggerated. Set aside six hours to dry.

While the glue in these joints is hardening, the top may be made, according to directions given below, p. 109.

When the glue in the frame joints is hard, take off the clamps, pull out one nail at a time (see *Handwork in Wood*, Fig. 163, p. 96) and bore with a 5/16" bit a hole 2" deep, Fig. 137. To gage the depth, use the auger-bit-gage, (*Handwork in Wood*, p. 116) or improvise one by boring a hole

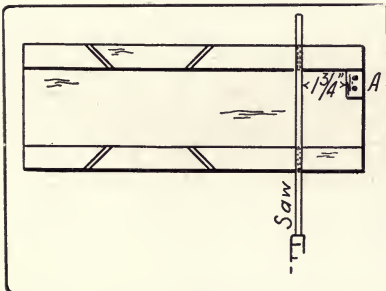

Fig. 131. A stop A, in miter-box for use in cutting the dowels of equal length.

time (see *Handwork in Wood*, Fig. 163, p. 96) and bore with a 5/16" bit a hole 2" deep, Fig. 137. To gage the depth, use the auger-bit-gage, (*Handwork in Wood*, p. 116) or improvise one by boring a hole

lengthwise thru a piece of wood of such a length that when this piece is slipped up to the jaws of the brace, two inches of the bit will protrude. See Fig. 138.



Fig. 132. Driving dowel thru dowel-plate.

As each hole is bored, work some glue into it by means of a small dowel-pin (say $\frac{1}{4}$ " diameter) and insert one of the $\frac{5}{16}$ " x $1\frac{3}{4}$ " dowel pins already prepared. In order to keep the work clean put no glue on the pin itself. With a mallet, drive in the pin leaving $\frac{1}{8}$ " projecting.

In order to make sure that all the pins project an equal amount lay a strip of wood, $\frac{1}{8}$ " thick, next the pin as you drive it in, so that the mallet head will hit the strip on the final blow.

The reason why the dowel pin is not made long enough to drive it clear to the bottom of the two inch hole is because the glue at the bottom of the hole may act like a cushion, which, if the pin is driven home, may force open the joint between the joint and the stretcher.

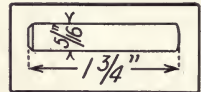

Fig. 133. Dowel-pin for taboret.

In case it is not convenient to round off the ends of the dowels before driving them, or in case they are not driven in so that the projections are all equal, proceed as follows: Saw off the protruding

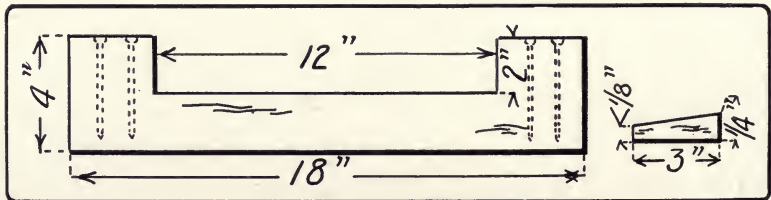

Fig. 134. Improved clamp.

parts of the dowels to within $\frac{1}{8}$ " of the surface, thus: Holding the frame in the vise, as in Fig. 139, lay a piece of wood $\frac{1}{8}$ " thick next each pair of dowels, and resting the face of the back-saw on this, saw off the dowels. Then round up the $\frac{1}{8}$ " projections into buttons thus:

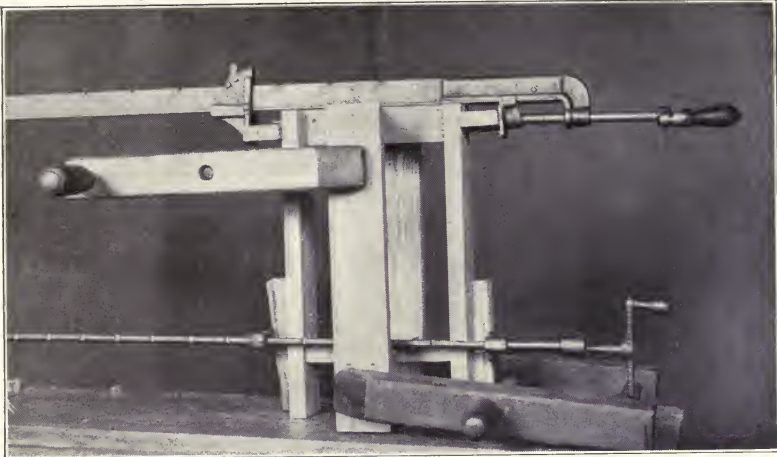

Fig. 135. Taboret, nailed, glued, and clamped.

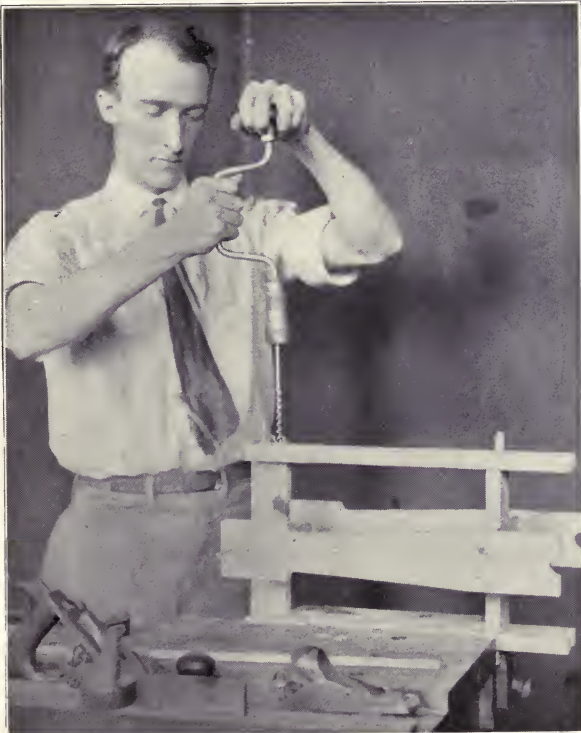

Fig. 137. Boring the holes for the dowels.

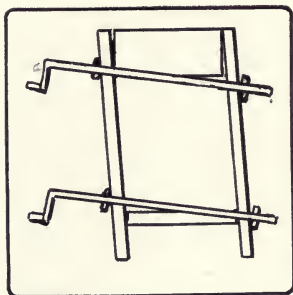

Fig. 136. Method of squaring up angles.

to drive the pins flush with the face of the legs, smooth off the surface, and drive upholstery nails, Fig. 141, of the appropriate color into the surface of each dowel. The taboret shown in Fig. 142 is finished in this way.

If the processes so far have been neatly done, there should be very little superfluous glue to clean up. If there is any, clean it off with a chisel and scraper. This process may sometimes be facilitated by dampening the glue with a little hot water on cotton waste. Use as much heat and as little water as possible.

If any bruises appear on the surface in which the fibers of the wood are crushed but not cut, wet such places, cover with a piece of paper, and lay on them a flat-iron, sizzling hot. This will swell the fibers back into shape. Finally sandpaper all over.



Fig. 139. Sawing off projecting end of dowel-pin.

To fasten the plates to the frame, it is first necessary to bore holes, with a twist-drill, in the middle of the plates and countersink

Fold a piece of sandpaper, sand side in, hold it near a dowel as a buffer, and with a chisel, bevel side down, resting on this sandpaper, slice off the arris of the projecting dowel as in Fig. 140. When the arrises are neatly trimmed, sandpaper the end of the dowel into a button shape, holding the sandpaper over the thumb. Finish the remaining dowels in the same manner.

Instead of shaping the protruding dowel pins into buttons, an easier way to finish is



Fig. 138. Improved bit-gage.

Next cut out the recess for the brass plates with which the top is to be fastened to the frame, as in Fig. 125. This dado is cut at both the extreme ends of each upper stretcher, and is $\frac{1}{2}$ " wide and as deep as the thickness of the plate.

this hole on the side opposite to the other countersinks. It may then be screwed into place, using $\frac{5}{8}$ " No. 4 screws, Fig. 125.



Fig. 140. Method of trimming arris on dowel-pin.

The top is made as follows: Assuming that it is to be made of two boards jointed together, cut them slightly longer than wanted ($13\frac{1}{2}$ "). If they are warped



Fig. 141. Upholstery nail.

at all, joint them so that the warp will be reversed in the two pieces, as in Fig. 143. Then proceed as in the directions for a rubbed joint given in *Handwork in Wood*, p. 172. When dry, plane the board to the proper size, 13" square and $\frac{3}{4}$ " thick, following the order given in *Handwork in Wood*, p. 72.

To lay out the octagon, either the 8-square measure on the steel square may be used (*Handwork in Wood*, p. 108) or the following method: Draw the diagonals of the square (13") as in Fig. 144. With the compasses take the distance from any corner, (say *A*) to the center, *E*, and lay this off along *AB* and *AD*, getting the points *F* and *F'*, *G* and *G'*, etc. Connect *F* and *G*, *F'* and *G'* etc., and the octagon is drawn. Saw

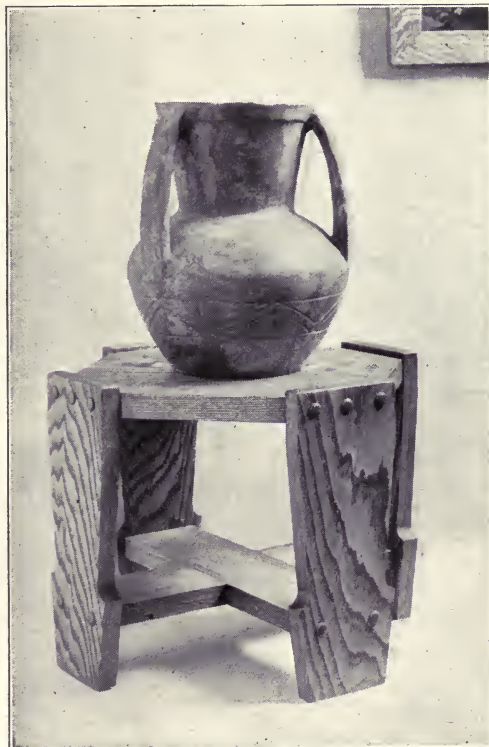

Fig. 142. Dowel ends covered with upholstery nails.

off the corners and plane true. If the design calls for it, the chamfer may be taken off at this time from each upper arris.

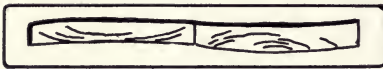

Fig. 143. Method of jointing two boards.

To fasten the top to the frame, lay the top, bottom side up, on the bench, taking care that there is nothing rough on the bench to mar the top, and accurately locate the frame on it. Be sure that the grain of the wood of the top runs parallel to one stretcher. Screw it firmly in place. If the top has become slightly warped, do not try to force it flat by means of the screws, but clamp it carefully in place first with hand-screws and then drive the screws home.

The taboret is now ready for staining and finishing. If it is made of chestnut, a very handsome seal brown can be obtained by shutting it up in an air tight box with one-half pint of strong ammonia (28%) in an open dish. Let it stand for 24 hours or more, and then oil it with a mixture of one part boiled linseed oil and two parts of turpentine. Wipe off carefully. Inasmuch as the taboret is likely to be used as a stand for a flower-pot, it should not be shellacked or varnished, for shellac and varnish are apt to discolor under water, but it should simply be oiled and rubbed again and again, but principally rubbed. This can be done very easily with a buffing wheel on a lathe.



Fig. 145. Legs doweled directly into top.

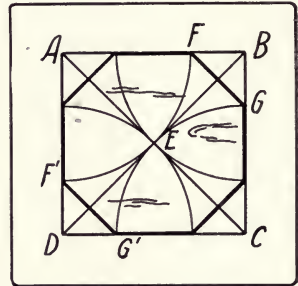

Fig. 144. One method of laying out an octagon.

If made of cypress, the taboret should be stained so as to bring out the contrast between the yellow spring

wood and the red summer wood of the annual rings. See *Wood and Forest*, pp. 11 ff. For this purpose oil stains are the most satisfactory. See *Handwork in Wood*, p. 209.

An agreeable modification of the design described above is to set the lower stretchers edgewise, not flat, omit the upper ones, and fasten the upper ends of the legs directly to the top, into which they are notched, as in Fig. 145.

In this case the lower stretchers are located in the legs by perpendicular center lines on the legs, as in Fig. 146. For fastening the legs to the top after it is glued up and dressed to size, if the legs are to be perpendicular, not slanting, lay out on the top the notches for the legs so that the distance from opposite ones shall be exactly equal to the length of the lower stretchers. Do all the laying out from the working edge (*Handwork in Wood*, page 72). See also Fig. 147. Lay out on both sides of the piece in order to insure accuracy in chiseling later.

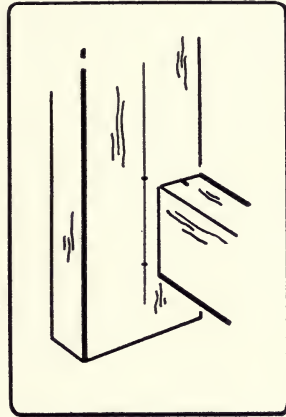

Fig. 146. Locating position of end of stretcher on leg.

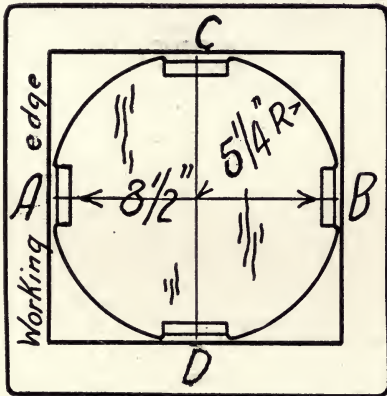

Fig. 147. Lay-out of taboret with legs doveled into circular top.

If the top is to be circular, lay out the notches first. Then lay out and cut the circle and finally cut the notches. This order prevents the sides of the notches from splitting off in dressing up the circumference.

Lay out the circle 10 1/2" in diameter. Then the top will project slightly beyond the outside of the legs, as in Fig. 147. The circle is to be cut out with a turning-saw. (*Handwork in Wood*, p. 67,) and dressed up

with the spokeshave. To cut out the notches, use the back-saw, cutting just inside the lines, and chisel out the waste. In chiseling out the parts that run parallel to the grain, (A and B, Fig. 147) cut

only a little at a time for fear the wood may undersplit. In chiseling out the parts across the grain, (*C* and *D*) lay the piece down flat on a piece of waste wood on the bench and fasten it firmly with



Fig. 148. Starting to cut out the notches.

a handscrew or between bench-stop and vise-dog. First place the edge of the chisel (a broad one) exactly on the line, hold it perpendicular and tap it lightly with the mallet. Then holding it obliquely, cut out a triangular groove, as in Fig. 148. With this groove once fixed, you can proceed more rapidly and with heavy strokes. When about half-way thru the piece, reverse it and cut from the other side. Take care to keep the bench top free of chips or the wood will be marred. Trim out the sides of the notches so that the legs will fit exactly. If arrises are to be chamfered or rounded, do it now.

In assembling, proceed as before, page 104, nailing first, and then substituting dowels for nails.

A more elaborate six legged taboret is shown in Fig. 149. In this case there is no half-lap joint, but the legs are doweled into two boards, top and under, both of which are notched to receive them. The process of assembling is as described above, nailing with glue, extracting the nails, and substituting glued dowels. The one shown in the figure was made of cypress, stained brown, and oiled and rubbed repeatedly.

If the legs of the taboret are to be not perpendicular but slanting, as in Fig. 150, the proper "batter" or angle at the ends of the stretchers may be obtained by means of the steel square, a straight edge, and the bevel. See Fig. 151. Suppose the distance



Fig. 149. Taboret with six legs.

from the top of the upper stretcher to the bottom of the lower stretcher to be 13" and the bottom of the lower side of each arm of the lower stretcher to be 1" longer than the top of the upper surface of the arm of the corresponding upper stretcher. Lay the steel square on a board with a straight edge, placing the 13" mark on the blade and the 1" mark on the tongue exactly on the straight edge. With a pencil scribe on the board the angle which the tongue makes with



Fig. 150. Taboret with slanting legs.

the straight edge. This is the angle needed for the ends of the stretchers, and also the angle for the tops and bottoms of the legs. (See *Handwork in Wood*, 3rd edition, p. 201, note.) Transfer this angle by means of the sliding T-bevel. See *Handwork in Wood*, p. 113.

Fig. 152 shows a foot stool made of mahogany with a woven reed seat, stained to match the mahogany. The top is a frame made with end-lap joints, each member $3\frac{1}{2}$ " wide so as to give plenty of surface for gluing.

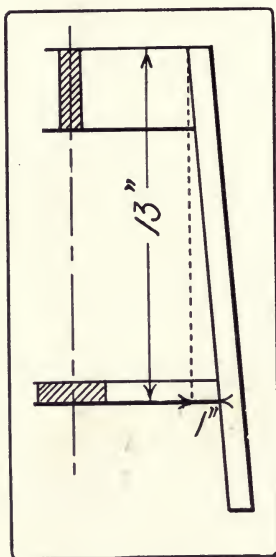

Fig. 151. Obtaining the batter for slanting legs.



Fig 152 Mahogany stool with woven reed seat.

CHAPTER IX

MALLET

The excellence of design in a mallet depends primarily upon its utility. The "fixing of essentials" is paramount in importance. Whatever grace of form or refinement of proportions it may have are the result of adaptation to use. In an object of such hard usage, dec-



Fig. 153 Mallet.

oration too must play a minor part. As to essentials, a mallet must be of proper weight, must "hang" well in the hand; the head must be of the hardest wood available, that will not easily split, as maple; the handle must be of a tough elastic wood, as hickory, and its form

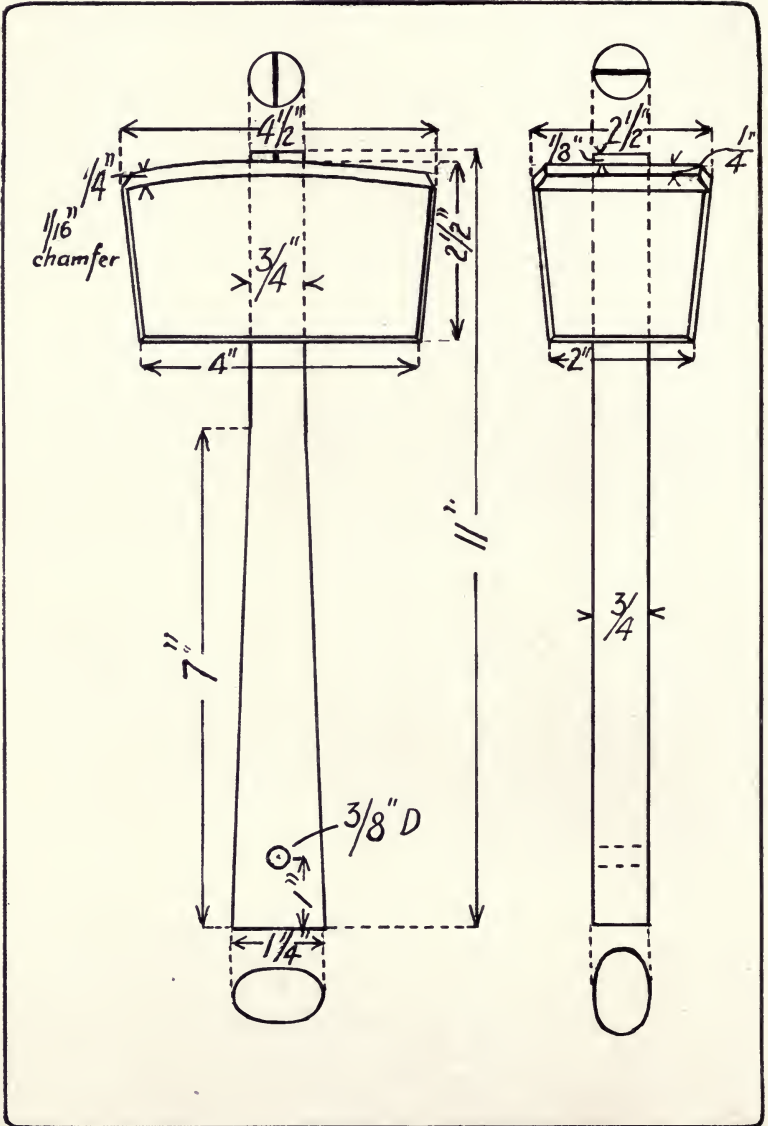

Fig. 154. Working drawing of mallet.

should be oval, so that the worker can feel, without seeing, that the face of the head will strike square. The handle should be joined firmly to the head, as with the round mortise-and-tenon, wedged, and there should be a convenient method for hanging it. A coating of shellac helps to keep the wood clean, and improves the looks. Some prefer to have tool handles left unvarnished, because of the notion that raw wood does not blister the hand. The design here given, Figs. 153, 154, stands all these tests.

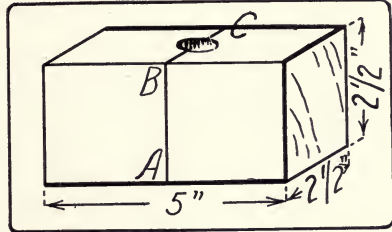

Fig. 155. Maple block for mallet-head.

The materials required are:

- 1 piece maple, $2\frac{1}{2}'' \times 2\frac{1}{2}'' \times 5''$.
- 1 piece hickory, $\frac{7}{8}'' \times 1\frac{3}{8}'' \times 11''$.

The head, maple. Plane up true the working face, working edge, the width and the thickness. With the try-square, carry a fine pencil



Fig. 156. Boring hole in head of mallet.

line across the center on all sides as in Fig. 155, *A B C*. Notice carefully how the annual rings run in the piece. Like most all woods,

maple is less likely to split with the annual rings than across them. (See *Wood and Forest*, p. 53.) Therefore plan to make the hole for the handle as nearly as possible along the annual rings, as in Fig. 155.

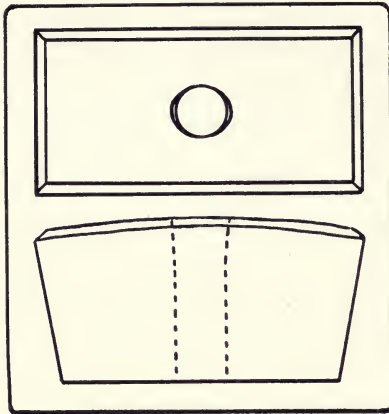

Fig. 157. How the handle hole tapers out.

the wood at right angles, both horizontally and perpendicularly, and when the hole is once started, use only a down stroke with the ratchet brace. The brace is thus held steadier and works easier than when it is swept round and round. If two persons can work together at this process, one can test the bit with the try-square, while the other bores. Bore half-way thru and repeat from the opposite side.

With reasonable care, the holes should meet exactly. If they do not, chisel off the projecting shoulders inside the hole with an inside bevel gouge ($\frac{3}{4}$ ").

In order that the handle may be firmly held in the head by means of a wedge, as described below, it is necessary to enlarge with the inside bevel gouge ($\frac{3}{4}$ " two sides of the hole in the head at what is to be the outer (curved) edge. Make these cuts so as to have the hole oblong in the direction of the length of the head, that is, $\frac{7}{8}$ " wide on the long axis and taper it inwards for $\frac{3}{4}$ ". See Fig. 157.

To determine the location of the handle hole, mark with the marking-gage the center point on the cross lines already drawn, on two opposite sides. Fasten the block, thus marked, firmly in the bench vise, as in Fig. 156. Put a $\frac{3}{4}$ " auger-bit in the ratchet-brace, hold the knob of the brace in the hollow of the left hand and hold the body firmly against it so that it will change position as little as possible; with the try-square, see that the bit enters

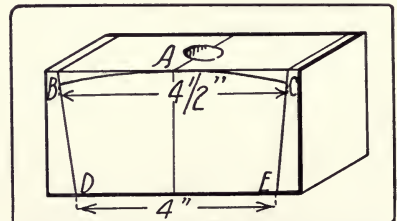

Fig. 158. Lay-out of sides of mallet-head.

Next lay out, according to the dimensions given in Fig. 154, the shape of the head on the broad side. The curve for the outer edge can be obtained by making a templet of cardboard or thin wood, thus:

The curve is the $4\frac{1}{2}$ " arc of a circle whose radius is 22". Set this templet exactly in place, as at A B C, Fig. 158, and scribe the curve. Or let one person bend and hold a thin spline of wood at the proper place, and another scribe with a pencil along it.

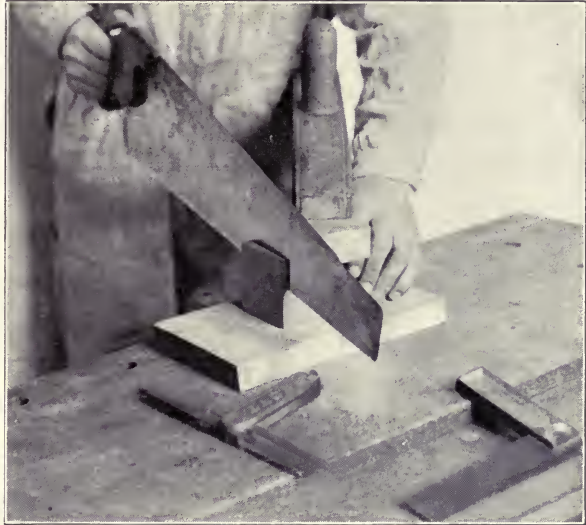

Fig. 159. Sawing the bevel on the mallet-head by means of a block clamped on as a guide.

To lay out the bevel of the ends (faces) of the head, set the T-bevel at the angle of the inner edge with the faces, and by means of this and of the try-square, score lines all around with a sharp knife. Make a groove for sawing on the outside of the bevel lines *B D* and *C E*, Fig. 158. (See *Handwork in Wood*, p. 66, Fig. 91), and saw off the waste.

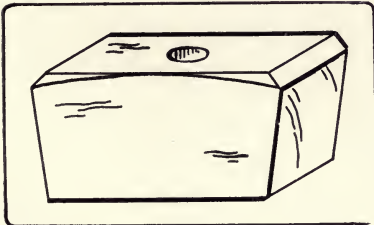

Fig. 160. Block chamfered to avoid splintering when end planing.

To guide the saw, another block of wood with true square edges may be set along the scored line and clamped down with a handscrew on the bench, Fig. 159. Take the precaution, however, to protect the bench by a piece of a waste board underneath the block to be sawn. Saw with a crosscut-saw, just outside the scored lines. Repeat at the other end.

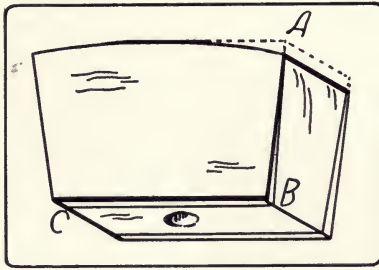

Fig. 161. Lay-out for beveled sides. (Seen from below.)

To plane these ends, fasten the piece upright in the vise. Avoid splintering by cutting chamfers at the outer arris, as in Fig. 160, and plane the ends flat and smooth. For this purpose the jack-plane is best, well sharpened and set fine. The block-plane is too light.

Next plane the waste off the curved outer edge. To rough off, plane across the grain. Finish with the grain for smoothness, using a circular plane if handy.

Next lay out on these planed ends and on the inner lower edge the bevels of the sides, as *A B C*, in Fig. 161, and plane off the waste.

With a pencil lay out the chamfers, which are $\frac{1}{4}$ " on the arrises of the curved surface and $\frac{1}{16}$ " on the rest, and plane them off.

The Handle. True up the piece to a $\frac{3}{4}$ " x $1\frac{1}{2}$ " x 11", full. Draw, with a pencil, a fine center line on both broad sides and on the ends. On both broad sides lay out the plan of the handle, working from the center line. Bore a $\frac{3}{8}$ " hole, 1" from the hand end thru the short axis, for convenience in hanging up the mallet.

Rip-saw off the waste, working from both ends. In order to start the saw on the tapering cut, clamp a piece of waste wood to the handle, as *A*, in Fig. 162, and start the saw at *B*. Save one of the pieces thus sawn off to be used later to wedge the handle into the head. Spokeshave to the lines drawn, keeping the piece rectangular. Draw center lines on both edges and on the ends.

Lay out with a sharp pencil the chamfers which are to make the piece eight-sided, and on the large end draw as exact an ellipse as possible. Spokeshave these chamfers and then



Fig. 162. Method of starting saw on a tapering cut.

round the small end till it fits closely the hole in the mallet head. Be careful in using the spokeshave to keep the piece of even diameter thruout. In cutting the very end the spokeshave is likely to taper it. To avoid this, hold the spokeshave, not at right angles to the axis of the piece, but diagonally.

Spokeshave the large end to an elliptical section. The shape should change smoothly into the rounded small end. Scrape smooth and sandpaper.

In the small end cut with the back-saw, a kerf 1" deep, Fig. 154. Be careful to cut this parallel with the short axis of the ellipse at the other end. This is to receive a wedge, which may be

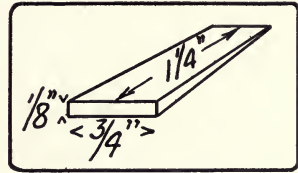

Fig. 163. Wedge for handle.

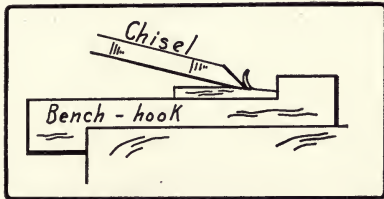

Fig. 164. Method of cutting a wedge.

made from one of the pieces sawn off in making the handle. The wedge should be $\frac{3}{4}$ " wide, $\frac{1}{8}$ " at one end and tapering to an edge, and 1" long, Fig. 163. Place one end of this piece on the bench-hook against the cross-cleat, and chisel this end to an edge. See Fig. 164. Drive the handle in the head, letting the small end project $\frac{1}{8}$ ". Dip the wedge in glue and drive it in place. Saw off the projecting part of the wedge, clean up, and sandpaper.

Give the head a couple of coats of shellac and rub down with steel wool.

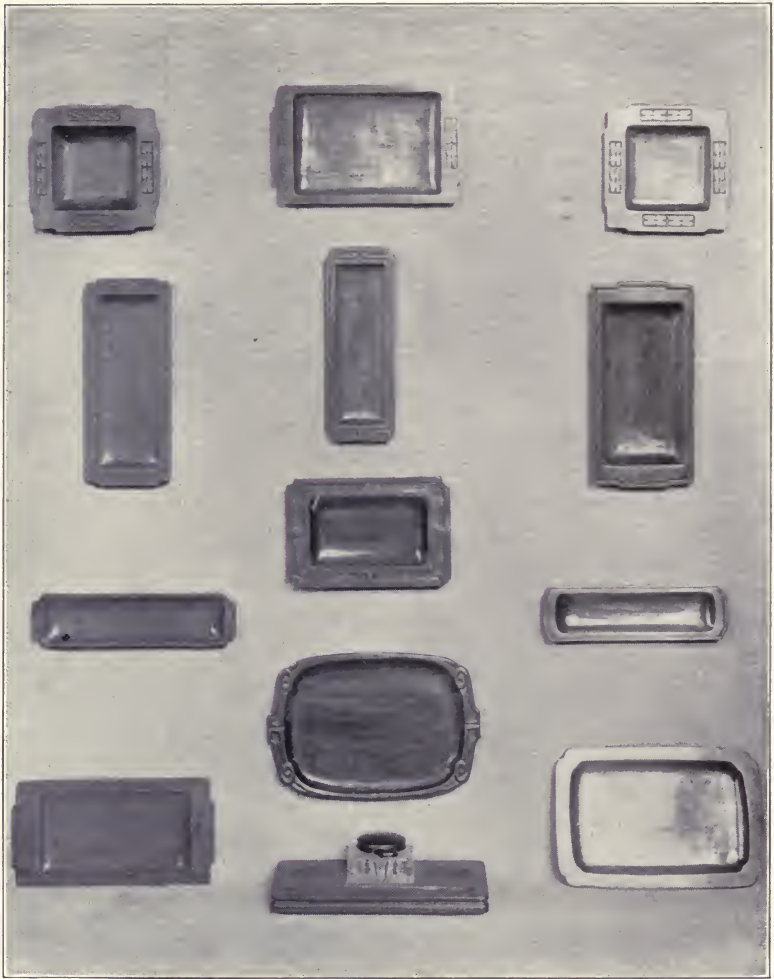

Fig. 165. Trays.

1
2
3
4

5
6
7
8
9

10
11
12
13

CHAPTER X

TRAYS

One of the most valuable projects for a beginner in woodwork to make, looked at either from the point of view of the discipline of technique or from that of design, is a tray for pens or cards, trinkets or pins, clips or collar buttons, or whatsoever. For varieties of trays see Fig. 165.

The first matter to decide is, of course, the use of the tray. If it is to be for penholders and pencils, the trough must be long and



Fig. 166. Trays.

1 2 3
4 5

wide enough to receive them, and the tray must be stable, so as not to be easily upset. If for cards, or crackers, it must be so designed as to be easily picked up. A suitable wood for this project is sweet gum, because it is of close even texture, moderately soft, cuts clean, polishes well, and has a handsome color and figure. *The fixing of the essentials* is an easy matter.

The beauty of the tray will depend upon the refinement of its proportions and such embellishments as there are in the way of carving. These are very closely related in this project. That a pen-tray should not be bulky or clumsy goes without saying. But its lightness and grace may depend as much upon the carved embellishments, Fig. 166, Nos. 1, 2, 3, as upon the modeling of the edge, Fig. 167.

A few suggestions may be offered as to the use of line decoration. It is the simplest form of carving and yet lends itself to endless variety. See Figs. 168, 169. One danger in line design is that the lines be too "wiry" or "wormy". This can be corrected by breaking



Fig 167. Tray with surface and edge modeled.

the lines and modifying the ends. It should also be remembered that the blank spaces, that is, those uncarved, should make a pleasing pattern, as well as the carved lines themselves. The rosette design, shown in Fig. 170, is a pure line design, so arranged that the blank spaces make a rosette. An interesting discussion of the breaking up of spaces will be found in Ernest A. Batchelder's *Design in Theory and Practice*.

In making the tray itself the processes are few and simple, but like all good carving, require careful control of the hand, and call for considerable variety of manipulation.

Taking for illustration a typical tray, the pen-tray with rosettes, shown in Fig. 170, first, with the plane, true up the working face, working edge, length, width, and thickness. If the design is not rectangular, but has curved outlines, it is necessary to true up only working face, working edge, and thickness.

To lay out the design, draw on the working face, center lines, one lengthwise, one crosswise, at exact right angles to each other. Draw similar lines on the design.

Lay the design already drawn in paper on a piece of glass, and with a sharp knife point, make a clean cut stencil of one quarter of

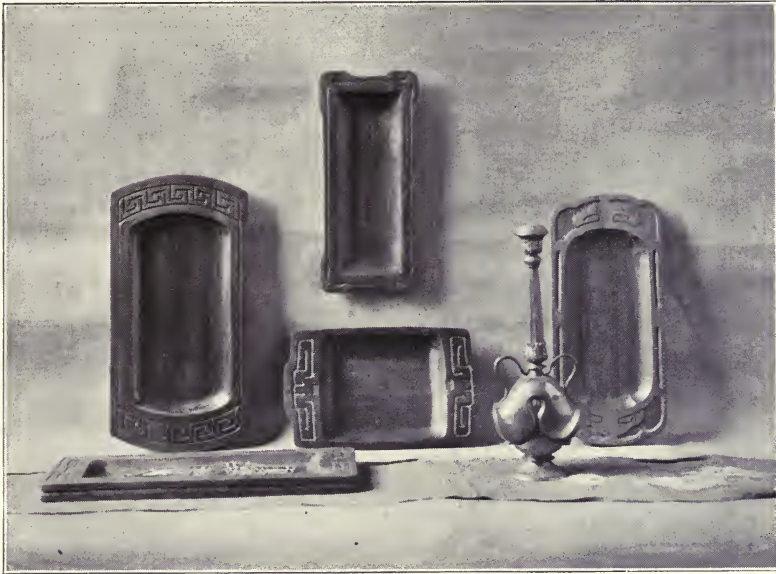

Fig. 168. Varieties of line carving.

it. Where necessary to prevent the stencil from becoming too weak or falling apart leave little bridges to hold the parts together, as *A A*, in Fig. 171.

From this stencil, lay out the design on each quarter of the working face of the board. If it is necessary to pin it in place, do so in places where the pin pricks will afterward be cut away. This is more important in a fine textured wood like gum than in a coarse textured wood like oak.

As to when the outline is to be cut, that depends upon its shape. If it is nearly rectangular, it may be shaped before the trough is dug, but ordinarily, and especially if it is curved, it is better not to touch it, until trough and decoration are finished. In this rectangular shape, the edges will not be bruised while handling and it will be

easier to hold the piece between the bench-stop and vise-dog. For directions for shaping the outline, see below.

Next gouge out the trough of the tray with a large (1") outside bevel gouge. Work both with the grain and across it, noting care-



Fig. 169. Trays with line grooving.

fully any dips in the grain, and taking particular pains at those places. Do not attempt to work within $\frac{1}{8}$ " of the margin of the trough, until the main part is well gouged out. That is, leave the

finest work till later, because with every added stroke greater control of the hand is gained. For use of gouge on ordinary cuts, see *Hand-work in Wood*, p. 60.

For delicate cuts learn to use the twisting motion i. e., while pushing the handle with the right hand, gently twist the gouge on its



Fig. 170. Tray and blotter-holder with pattern of rosettes.

axis. This motion is particularly useful when approaching an outline, as of the trough. Twist away from the outline, then if the tool slips no harm is done.

Particular pains must be taken with the corners of the trough if there are any. In general they look better rounded. The arc of the round should not be greater than the arc of the gouge which you have to use. The sharper the corner, the harder it is to cut it out well.

For very accurate work, and where the cross-section of the tray is uniform for some distance, as in Fig. 172, it is well to make a templet of thin wood with which the work can be gaged as one proceeds.

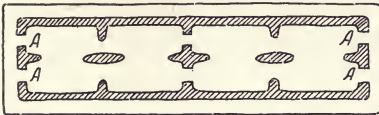

Fig. 171. Stencil, showing bridges at A, A.

But in many trays (as in Fig. 170) all that is necessary is to have a depth-gage.

For this purpose a nail driven into a strip of wood having a straight edge will suffice, Fig. 173. With this it is easy to detect variations which make the work look slovenly. The curve of the edges of the trough

may be often be determined by the curve of the gouge in use. Be sure to keep the gouge sharp at all times. For the method of whetting the gouge, see *Handwork in Wood*, p. 60.

In some designs (see Fig. 174) the piece is finished with the tool marks frankly shown. This is, on the whole, better suited to large

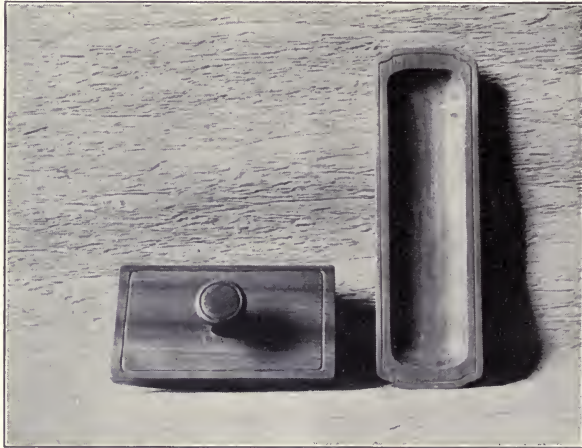

Fig. 172. Tray and blotter: simple outline decoration.

pieces made of coarse textured wood. For the sort of designs shown herewith, a smooth perfect finish is recommended.

After chiseling with the gouge as accurately as possible, scrape the surface of the trough with a cabinet scraper. No. 2 and No. 7 are the most useful. First see that the scraper is well sharpened. The method of sharpening is described on page 92, of *Handwork in Wood*.

By tilting and turning the scraper in various directions, the curve can be made to fit the triangle.

It is often possible to detect unevennesses on the surface which are not visible to the eye, by means of the touch. If necessary, shut your eyes while you feel. Make the surface as perfect as possible with the scraper. Preserve the edges of the trough sharp.

Next sandpaper the trough of the tray, using the tip of the thumb as a cushion for the sandpaper. It frequently happens that in sand-



Fig. 173. Depth-gage: nail in a strip of wood.

papering, irregularities in the surface undetected before will appear. If so, go back to the scraper, or even the gouge. But remember that the fine particles of sand rubbed into wood, will quickly dull edge tools.

Next cut out whatever decoration there is in the design. If this is a mere line design, as in Fig. 165, Nos. 2, 6 and 11, one tool is

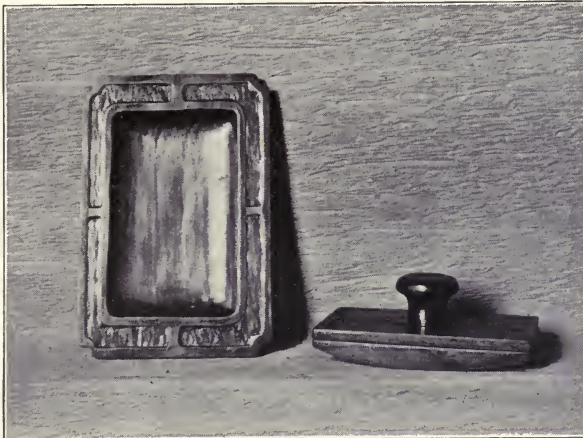

Fig. 174. Tray and blotter with tool marks of gouge left showing.

sufficient to cut it all out. This tool must be sharp, so sharp that it will cut soft wood across the grain clean without any tearing. Ordinarily no scraping or sandpapering will follow line decoration.

Be careful at the ends of the lines. Do not let them fade away, as *A*, in Fig. 175, but finish clean and round, as at *B*.

For quite fine lines, as in Fig. 172, a veining tool, so called, is used. This is simply a very small gouge, and has to be whetted with a slipstone having a knife edge. Such a design as the rosette is made with a veining tool. The especial danger in using the veining tool, is that it will slip beyond control and mar the wood.

Curved lines must be followed by hand, but straight lines may be kept straight by running along the edge of a rule or other straight edge held firmly in place, Fig. 176.

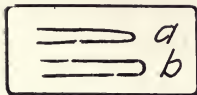

Fig. 175. How to finish ends of line carving: *a*, wrong; *b*, right.

Once the gouging is finished, the outline of the tray may be shaped. If the curves of the outline are large, use the turning-saw

(*Handwork in Wood*, p. 67) and the spokeshave (*Handwork in Wood*, p. 118); if small, use the chisel (*Handwork in Wood*, pp. 56, 57). Concave curves should be trimmed out with the inside bevel gouge and if quite small should be bored out with a bit of the proper diameter, before the lines adjoining them are cut with the saw or



Fig. 176. Guiding a veining tool along a straight edge.

chisel. For example, in Fig. 177, bore out *A* and *B*, locating their centers accurately, from the working face, *X*, before cutting out the longer curves.

If necessary, use a file or even a rasp to bring the line to shape. But if this is done, be careful to remove every trace of the tool marks afterward with the chisel and sandpaper.

In many of the designs shown, the edges of the outline are modeled, so as to give an appearance of lightness to the tray and to make

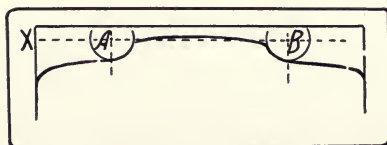

Fig. 177. Laying out curves.

it easier to pick up. In designing this feature, remember to keep the tray stable, that is, not to undercut the edges so far that the tray will tip over at a slight touch.

Make the base therefore at least as large as the trough. This may be done effectively by carving out a cove with the gouge as in Fig. 178. This in most cases would be wider at the ends of the tray than at the sides to correspond with

the design on the upper side. In this case let the side cove run smoothly into the end cove.

Or, the cove may be turned into an ogee by rounding with the chisel the lower angle, as in Fig. 178, *b*. Then the whole surface should be scraped even, and smooth, and sandpapered. Be very careful while working on the underside not to mar the upper surface.

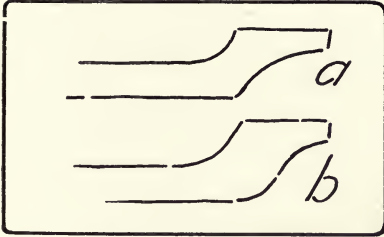

Fig. 178. Forms of cross-sections of trays.

Next rub the whole surface carefully with steel wool (No. 00) to get it as smooth as possible.

To bring out the grain of sweet gum, nothing is so good as a coat of boiled linseed oil (oil, 1 part, turpentine, 2 parts). Apply with a brush, rub well with cotton waste, and set aside to dry.

Then apply successive coats of white shellac, letting it dry for 6 hours or more, and rubbing it down with steel wool between each coat. Be very careful to avoid gobs, and to have each coat thin and even. Shellac is not to be smeared on.

Finally the whole may be polished on the buffer, or better still, by the process of French polishing, directions for which are given in *Handwork in Wood*, p. 217.

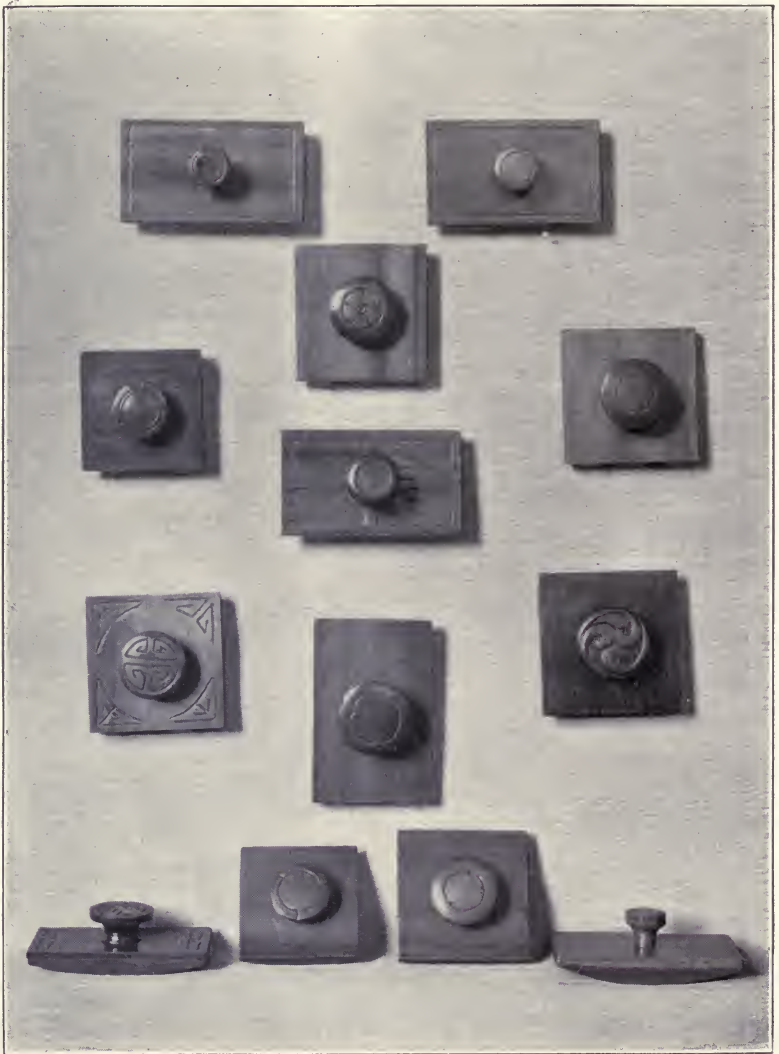

- | | | | | |
|---|---|---|---|----|
| 1 | | 5 | | 10 |
| 2 | | 6 | | 11 |
| 3 | | 7 | | 12 |
| 4 | 8 | | 9 | 13 |

Fig. 179. Rolling blotter-holders.

CHAPTER XI

ROLLING BLOTTER-HOLDER

The essential features of a convenient rolling blotter-holder are that it be the proper size and shape, say an oblong not larger than $3\frac{1}{2}'' \times 6\frac{1}{2}''$; that it be easily grasped; that the blotter be so fastened as to be easily changed; and that the blotter be properly cushioned.

In the device shown in Fig. 179 these requirements are met. The construction is as follows: A dowel on which a thread has been cut, is screwed and glued into the knob, while the part projecting from the knob passes freely thru a hole in the cover, $\frac{1}{4}''$ thick, and screws into the rounded part, Fig. 180.

The wood suggested is sweet gum, like the pen-tray described in the preceding chapter.

The proportions are largely determined by its use, the knob alone admitting of great variety in outline. The knob as well as the back may well be decorated with a pattern in harmony with that of the tray. See Fig. 181.

The making of the blotter shown in Fig. 182 will be described.

The materials needed are of sweet gum as follows:

- A. 1 piece, $\frac{3}{4}'' \times 3'' \times 5''$ (full).
- B. 1 piece, $\frac{1}{4}'' \times 3'' \times 5''$ (full).
- C. 1 piece, $1'' \times 1'' \times 2''$ and
1 dowel-rod, $\frac{3}{8}''$.

The new tool needed is a screw-box and a wood tap, size $\frac{3}{8}''$.

True up to size and dress carefully the two larger pieces *A* and *B*. Locate the center of each of these pieces. Bore a $\frac{3}{8}''$ hole thru *B*, and a $\frac{5}{16}''$ hole thru *A*, and a $\frac{5}{16}''$ hole into and nearly thru *C* at the center of one side. Take great pains to bore perpendicularly to the surface. With the tap, cut the threads in the holes, in *A* and *C*.

Select a straight grained piece of dowel-rod $\frac{3}{8}''$ diameter, and on one end by means of the screw-box cut a thread for two inches or more. If the box tears off the thread instead of cutting it clean, take

it apart, see that the cutter is sharp, reassemble, and try again. A little adjustment of the cutter back and forth may be necessary to get the best cut. Cut off two inches of the screw thus formed, work a little glue into hole—the 1" square piece, and screw in the dowel.

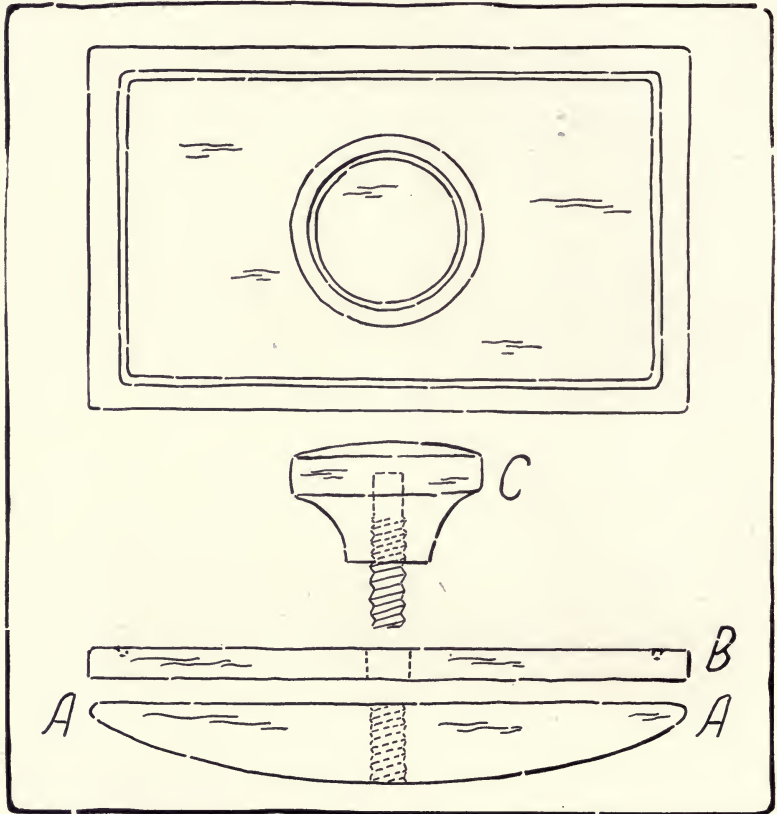

Fig. 180. Rolling blotter holder.

Now shape up the knob to the form desired. A piece 2" long was selected at the start in order to avoid the danger of splitting it while boring into it the $\frac{5}{16}$ " hole. Cut off the surplus $\frac{1}{2}$ " from each end, lay out the form on the two opposite sides, and with the chisel, gouge it and (or) file it and bring it into shape. If it is angular, it must be shaped by hand; if it is round, it may be turned on a lathe, if one is available. Shaping the knob by hand, is very difficult. Some may find it easy to whittle it into shape with a penknife.

If one is a novice at the lathe, do not try the wood turner's tangential cuts, but be content to scrape this piece into shape. Wrap a thickness or two of stiff paper around the projecting part of the screw and fasten it firmly but not violently into a three jawed chuck, and



Fig. 181. Rolling blotter-holder and tray.

then with sharp chisel and gouge, scrape it into shape, that is, hold the tool on the rest at right angles to the axis of the spindle. Use high speed on the lathe. See Fig. 183.

Next shape the roller part of the blotter. Lay out the curve on the two long edges of *A* with a templet of thick paper, cut to the proper shape. Saw off surplus with rip-saw. With chisel or draw-knife shape roughly and then plane to the line mostly across the grain, as in shaping the mallet head. (See p. 120).

Take care not to bring the curve to a knife edge with the upper face, but finish it as in Fig. 180, *A, A*.

Now carve the pattern designed to fit it. If the cut (groove) on the knob runs clear around it, as in Fig. 184, it can best be added

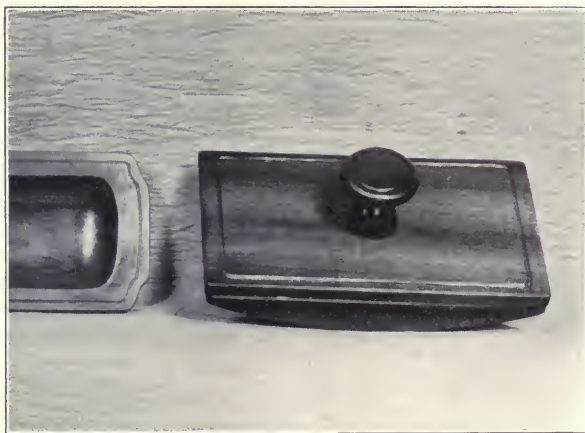

Fig. 182. Rolling blotter-holder.

while the knob is in the lathe. For this purpose use a $1/16''$ chisel ground to a round nose.

Add the decoration, if any, to the cover, *B*.

Finish in the same manner as the tray (p. 131).

A pad of felt, fastened to the rounded surface by means of thick shellac, gives a softer blotting surface. The pieces of blotting paper

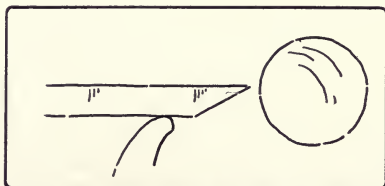

Fig. 183. Scraping the knob on the lathe.



Fig. 184. Turned knob

should be as wide as the blotter holder and long enough to fold well into the space between the roller and the cover. They are held in place by tightening the screw.

CHAPTER XII

SMALL BOXES

The size of such a box as is contemplated in this project is determined by its use. If it is for gloves it should be approximately 4"x5"x12". If for men's handkerchiefs, about 6" square and 4" or 5" deep. If for stationery, then to fit the stationery. In any case, the only safe way is to measure the proposed contents and make the box to fit.

The wood suggested is mahogany or black walnut or oak, all strong, handsome woods. For the joints possible, see *Handwork in Wood*, pp. 187-190.

In refining the proportions, sometimes even a slight modification from the dimensions which mere utility requires will give a more pleasing effect. Looking at each outer surface separately it may be said that oblongs are more pleasing than squares, or looking at the box as a whole, that cubes or multiples of cubes are to be avoided.

For embellishment the modifications suggested are:

(1) Extended tops and bottoms, as in Fig. 185, No. 3, with the edges modified by moldings.

(2) A simple outline of inlay.

The main esthetic reliance, however, should be on good proportion, accuracy of workmanship, and beauty of finish.

The directions following are for the construction of a trinket box, 3" deep x4" wide x7" long, outside measurements, of stock 5/16" thick when hand dressed. Fig. 185, No. 4.

The material may be black walnut or mahogany, and the following pieces are required:

2 pieces $\frac{3}{8}$ "x3"x7 $\frac{1}{8}$ ",

2 pieces $\frac{3}{8}$ "x3"x4",

2 pieces $\frac{3}{8}$ "x4 $\frac{1}{4}$ "x7 $\frac{1}{8}$ ".

(Or roughly speaking, a board $\frac{3}{8}$ " thick, 8" wide, and 20" long.)

2 brass butt hinges, 1", narrow.

8 brass screws $\frac{3}{8}$ " No. 2.

The grain of the wood in the four sides of a box should always run parallel, that is it should run either around the box or up and down. The reason is that with equal conditions of grain, any shrinkage that takes place will be even. In general the grain runs the long way of each piece. In this case of a long box, the grain should run around.

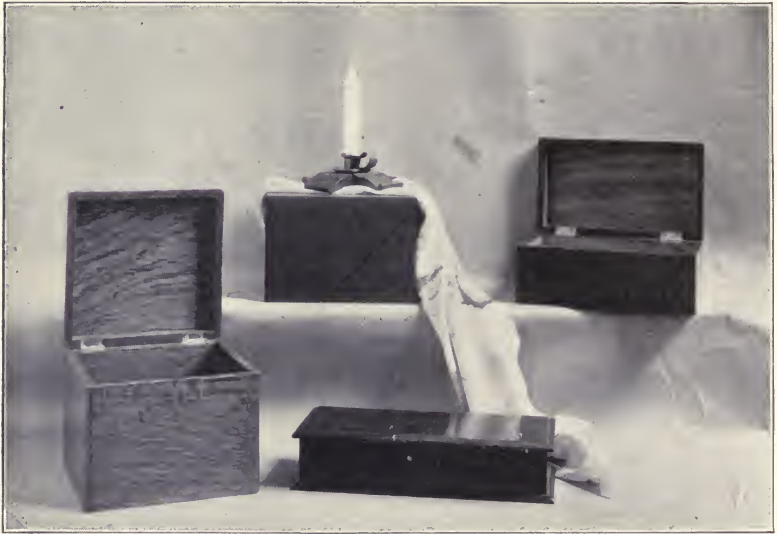

Fig. 185. Small boxes.

When not working on the pieces keep them clamped together in handscrews, (as in Fig. 5, p. 19) or at least keep them wrapped up in a paper to prevent them from uneven exposure and consequent warping.

In dressing up the pieces, proceed as follows: Cut from the wood, two pieces about $3\frac{1}{4}$ " wide and 12" long. Each will serve for one side and end, and each is to be kept in one piece thru as many processes as possible. Plane up the working face, the working edge, one end, the width, $2\frac{7}{8}$ ", and the thickness, $\frac{5}{16}$ ". The width should be 3" if the top is to be put on with a double rabbet joint, Fig. 186 B.

To fix the length of the end pieces, from the dressed end of each 12" piece measure off $3\frac{3}{4}$ ", score all around with a sharp knife and a try-square, cut a groove for the saw, (*Handwork in Wood*, Fig. 91.) but do not cut off. First plow the rabbets.

With the rabbet-plane plow the rabbets, $3/16''$ deep and $5/16''$ wide, on what will be the lower inside edge of the sides and ends. This is to receive the bottom. For directions for rabbeting, see p. 72.

If the top of the box is to be affixed with its full thickness showing, as in Fig. 186, *A*, no rabbet is cut on the upper edges of sides and ends. But a neater and stronger joint is the double rabbet joint shown in Fig. 186, *B*. If this is to be used, rabbet out the upper edges of the $12''$ pieces with a rabbet $3/16''$ deep and $3/16''$ wide.

Next saw off what will be the end pieces of the box and block-plane them true. Be careful that both ends are of exactly the same

size, $5/16'' \times 27/8'' \times 33/4''$, and all angles square. On both ends of each side piece, cut rabbets, (*Handwork in Wood*, page 179, No. 24) with the shoulders $63/8''$ apart, the rabbet $3/16''$ deep, and let the surplus length remain for the present. It can be trimmed off after the box is put together. See Fig. 187.

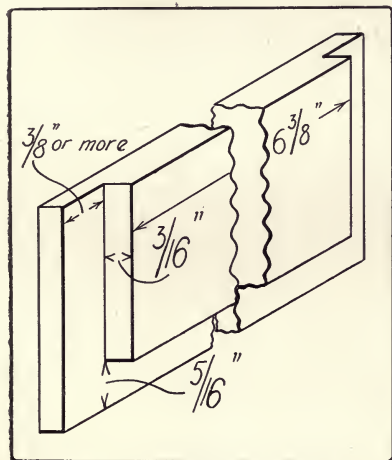

Fig. 187. Rabbetted side of box.

size, $5/16'' \times 27/8'' \times 33/4''$, and all angles square. On both ends of each side piece, cut rabbets, (*Handwork in Wood*, page 179, No. 24) with the shoulders $63/8''$ apart, the rabbet $3/16''$ deep, and let the surplus length remain for the present. It can be trimmed off after the box is put together. See Fig. 187.

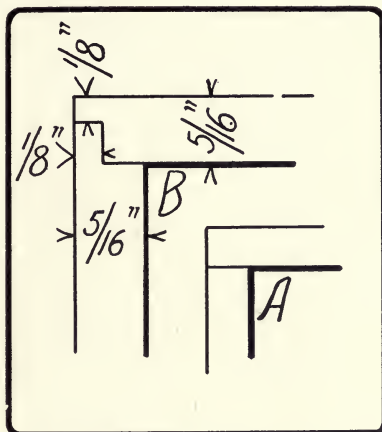

Fig. 186. Methods of affixing top of box.

Make these end rabbets as follows: Score and groove the shoulders with the try-square and knife. From this line score across the edges for approximately $3/16''$. With the marking-gage, gage on the ends and on the edges beyond the shoulders, a fine line, $3/16''$ from the side scored and grooved. With the back-saw, saw in the groove down to the gaged lines. Remove the surplus wood with a chisel, being careful to keep angles

square. From this line score across the edges for approximately $3/16''$. With the marking-gage, gage on the ends and on the edges beyond the shoulders, a fine line, $3/16''$ from the side scored and grooved. With the back-saw, saw in the groove down to the gaged lines. Remove the surplus wood with a chisel, being careful to keep angles

square and surfaces flat. The squareness of the box depends absolutely upon the accuracy of this rabbet joint. The sides and ends may now be assembled. Start brads ($\frac{7}{8}$ " No. 20) in lines $\frac{1}{4}$ " from the ends of the

box ends, as in Fig. 188.

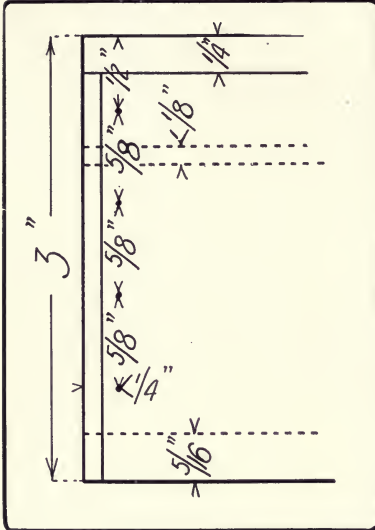

Fig. 188. Location of brads in end of box.

The reasons for this careful location are: at the double dotted line $\frac{1}{8}$ " apart, the box is to be cut in two, the upper part making the lid and the lower the box proper, and hence no brads must be in the way of the saw; and, second, the lower brad cannot safely be less than $\frac{1}{2}$ " from the lower edge on account of the inserted bottom. Start the brads so that they will be driven slightly outward, as in Fig. 189.

Drive the brads until the points just prick thru. Put a little liquid glue on the joints, put the parts together accurately, draw the sides up to the ends with a handscrew, being careful to place them so as not to buckle the sides, drive the brads home and set them carefully with a nailset. Test the inside angles to see

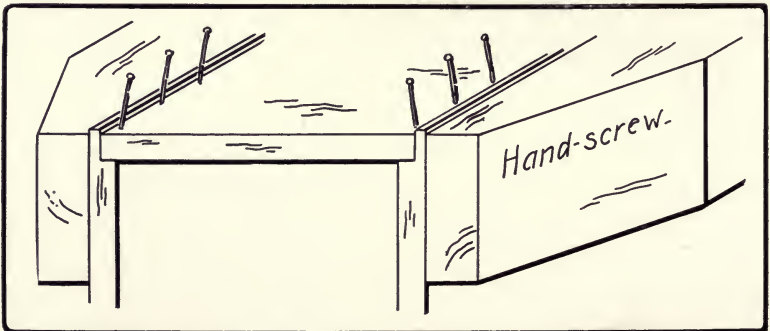

Fig. 189. Method of driving brads in box.

that they are exactly square. If instead of liquid glue, hot glue is used, everything must be in readiness beforehand, so that the work may proceed as fast as possible, before the glue sets. Set aside to dry.

The neatest way to conceal the holes made by the brads is this: Sharpen the end of a splinter of the same kind of wood as the box itself, so that it just fits a brad hole, dip the end in glue, tap it lightly into the hole with the hammer, cut it off with a sharp knife or chisel, sharpen the splinter again and so proceed till all the holes are plugged up.

While the frame is drying the top and bottom may be worked up according to the directions given below.

When the frame of the box is dry, test the upper and lower edges on a face plate, or some perfectly flat surface. If it rocks at all, note where and carefully plane it flat. In doing so, take care not to bump the toe or the heel of the plane into the inner arrises of the sides or ends, as at *A* and *B*, Fig. 190.

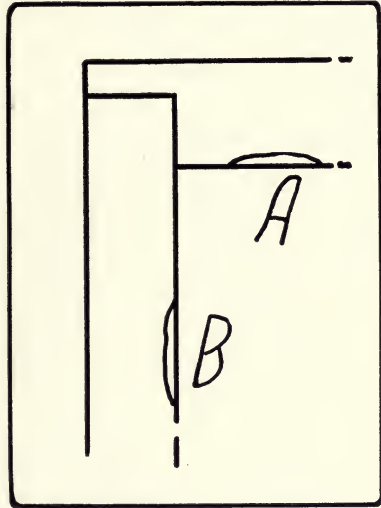

Fig. 190. Take care not to bump the plane into the inner arrises of the box, as at *A*, *B*.

Another way to bring the edges into plane, is to lay a sheet of sandpaper (No. 1) on a perfectly flat surface and rub the box back

and forth on it. The danger here is of rounding over the corners, as at *A* and *B*, Fig. 191. Next plane up the top and the bottom of the box, remembering

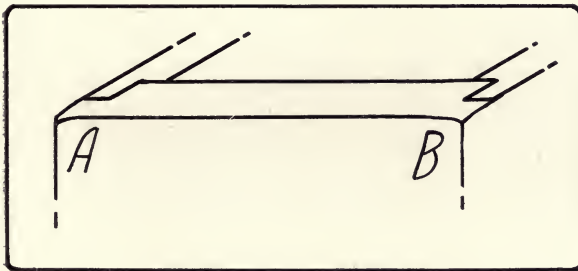

Fig. 191. Danger of rounding the corners, as at *A*, *B*.

ing to choose the better looking piece for the top.

If the top is to be affixed with a butt joint, as in Fig. 186 *A*, it may well be thinned to $\frac{1}{4}$ " or even $\frac{3}{16}$ ", because if thin, it is more easily kept from warping by the boxed part of the lid. Do not try

to fit the butt jointed top to the exact size of the box, but plane only the two faces. It can be dressed off after it is glued on.

If the top is to be rabbeted into the sides and ends, as in Fig. 186, *B*, these rabbets in the top may now be plowed. Plane up the top square, but slightly larger than it will be when the box is fin-



Fig. 192. Gluing the top on to the box.

ished. Plow out the rabbets $\frac{3}{16}$ " deep, and wide enough, just over $\frac{1}{8}$ ", so that the top will fit easily into its place. The bottom is to be $\frac{5}{16}$ " thick, and to be fitted exactly into the space rabbeted for it. Clean out any dried glue that there may be in the corners, apply a

thin film of glue to the joints, brad the bottom firmly into place, driving the brads thru the bottom up into the sides, and then set their heads.

Fasten the top without brads using only glue, hot glue, if possible. Since it has not yet been dressed to exact size, take care that the edges overlap all around.

In gluing on the top protect both it and the bottom by placing between the box and the handscrews other boards, otherwise the pressure of the handscrews may bend and even crack the top and bottom. Use plenty of handscrews. (See Fig. 192.)

When dry, say in six hours, dress off, sawing, if necessary, the projecting ends and edges. Take care not to splinter the corners.

Next, cut the box in two thus: With the marking-gage, gage two parallel lines, $\frac{3}{4}$ " and $\frac{7}{8}$ " respectively, from the upper surface of the top. Between these two lines saw the box apart with the back-saw, Fig. 193. For a larger box, the rip-saw would be used.



Fig. 193. Sawing the box apart.

Now plane each set of edges separately, first to the gaged line, and then test on a face plate, (flat surface) to see that they are in a plane. Finally test the cover thus: Lay it in place and tap each corner with the finger to see if it rests firm there. Examine the crack all around and correct any errors. Round the external arrises if desired (See Fig. 194) but in any case do not leave them sharp, except where the box and its lid meet. Clean up and sandpaper.

Setting the hinges. (See *Handwork in Wood*, pp. 131-133.) The hinges should be set about the length of the hinge from the ends of the box. Mark with the knife the length of the hinge on the edge of the back of the box, taking the length of the hinge from the hinge itself, by superposition. (*Handwork in Wood*, p. 204). Square across the edge with the try-square and knife. Do this for both hinges. Hold the

lid of the box in its proper place on the box as it will rest when shut, and mark the places for the hinges on the edge of the back of the lid, and square across for both hinges. Between these lines on both the inside and outside of the box and of the lid, gage the proper depth of the notch, i. e., one half the thickness of the knuckle of the hinge.

Chisel out the notches, set the hinges in place, drill or brad-awl the holes for a tight fit and drive the screws. Lubricate them with soap



Fig 194. A stationery box, external arrises slightly rounded.

before driving; otherwise they may break. If rightly done the lid should shut tight all around with no springing back. If it does spring back, the hinges are set too deep, and it is necessary to loosen the screws and set in a shaving under the hinge. If there is a gap between the box and the lid at the back, the hinges need to be set in a little more deeply. If the sides of the lid do not lie flush with the sides of the box, one hinge is set further toward the outside side of the box than the other. If this difference is very slight, it may be corrected by loosening the screws a little and gently but firmly twisting the lid around in the right direction. If the discrepancy is great, notice carefully

where the error is, take out the screws that are wrongly placed, cut little plugs of wood, dip in glue, drive into the screw holes, and bore new holes for the screws.

If a lock is needed for the box, see *Handwork in Wood*, p. 134, for directions for inserting it.

If the box has been made of mahogany it may now be stained in the same way as the candle-stick. See p. 92.

It looks well to stain only the outside including the edges where the lid meets the box, and to leave the inside unstained, as in Fig. 194.

When the stain is thoroly dry, and the surface well rubbed down with steel wool, give the outside a coat of Wheeler's Patent Paste Wood Filler, No. 7, (see *Handwork in Wood*, p. 213). Mix this filler with enough turpentine to make it the consistency of thin paste, apply with a brush with the grain, and as it dries, but before it sets hard, rub off the surplus carefully across the grain. The object of the filler is to fill up the pores of the wood and give a smooth even surface. The filler should dry for twenty-four hours. Then apply successive coats of shellac, rubbed down with steel wool, and, if desired, French polish it. (See *Handwork in Wood*, p. 217.)

If the box is of walnut, no stain is needed. A black filler (Wheeler No. 10) will darken it a little.

If the design of the box calls for a projecting bottom and top, as in Fig. 185, No. 3, several parts of the construction are different. The sides and ends are not rabbeted to receive either bottom or top, which are glued and nailed directly on their edges.

In gluing on a top which has been finished to size, and perhaps made with molded edges, pains must be taken not to let it slip when the pressure of the handscrews is applied. One method of preventing this is as follows: drive four brads into the upper edges of the sides, bite off the heads with the nippers and sharpen the projecting points. Set the top exactly in place and press it down so that the brads will penetrate. When the glue is applied see that the brads enter the same holes, and the top will remain true in place.

If the box frame is not to be cut in two, but the cover consists of only a top board suitably molded or otherwise decorated, care must of course be taken to select a well seasoned piece without any inclination to warp. The hinges in this case should be set entirely into the edges of the back.

Instead of the rabbet joint described, which has the disadvantage of the brad holes showing, several others are feasible as described in *Handwork in Wood*, page 187.

Box construction of a more simple form may be made use of in making bird-houses, as shown in Fig. 195. The necessity for making opposite sides of exactly the same size holds here as in all rectangular boxes.

CHAPTER XIII

LANTERNS

This project consists essentially of a frame covered with translucent paper or cloth. Fig. 196. It may be worked out in two different ways, either as a hanging lantern, Fig. 197, suspended by chains, or a lantern supported on the wall by a suitable hook, or on a bracket, Fig. 196, Nos. 1 and 4.

Either form may be so designed as to be lit either by a candle or by an electric light. The electric light is, of course, safer. In case a candle is used, a suitable socket and pan for the candle are essential, and the lantern must be large enough so that the flame of the candle cannot set fire to it. In the case of the wall lantern, the wall may be protected by a metal screen. Aside from these considerations, considerable latitude is possible.

The wood chosen for this project is yellow poplar because it is not likely to be split by the fastenings used. It has, besides, a smooth even texture that finishes well.

In a project as nearly rectangular as this, the chief consideration is to have a satisfying relation of height to width; that is, the faces are to be pleasing rectangles rather than squares.

The embellishments may take various forms. In Figs. 197 and 198, both the hanging lantern and wall lantern have the simplest possible frame with the interest centering in the stencils cut on the paper. In Fig. 196, Nos. 2 and 3, the pattern is made by the slats cross-lapped. The chain instead of being simple, as in Fig. 197, may have links of varying lengths.

Since in Fig. 196, Nos. 1 and 4, the lantern consists of a screen set on a bracket which also holds the candle, the design of the bracket should harmonize with the screen. (See *Handwork in Wood*, page 185).

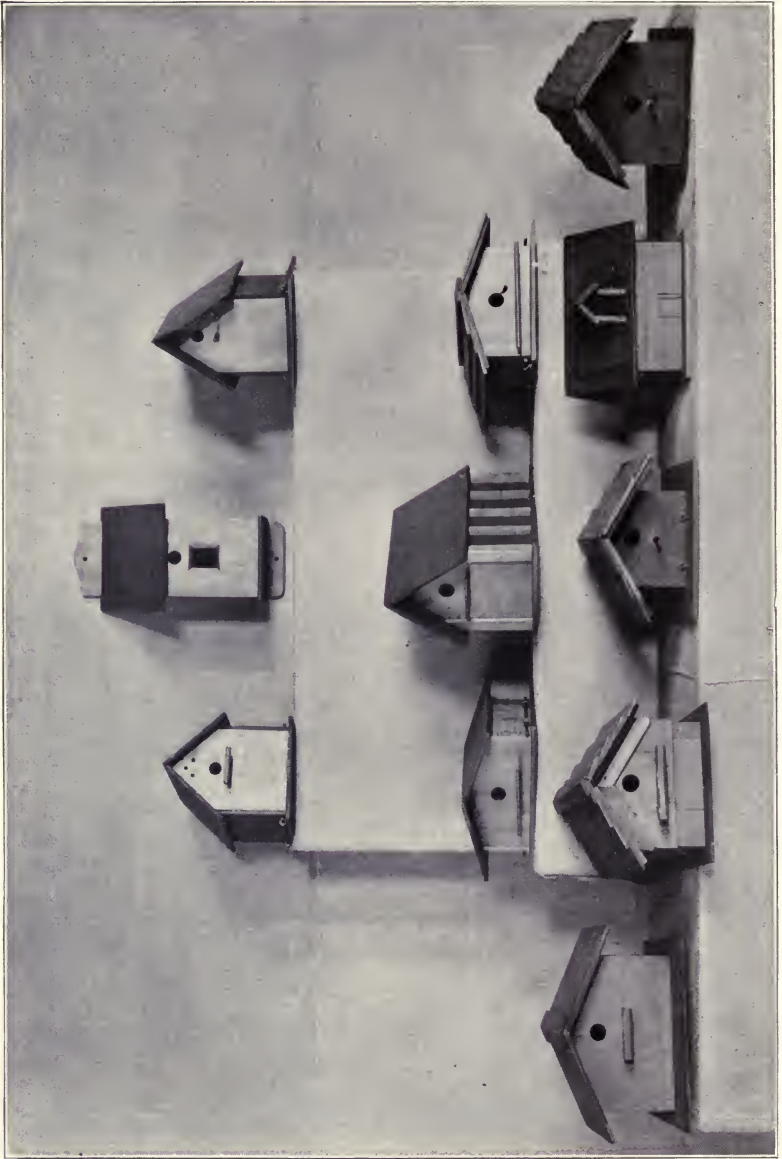

Fig. 195. Wren houses: entrance for birds must be $\frac{3}{4}$ " in diameter, so that nothing larger than a wren can enter.



1

2

3

4

Fig. 196. Lanterns.

I. *The suspended lantern* with the wood fret, Fig. 196, No. 2.

The wood selected for this is yellow poplar, $5/16''$ thick. The following sizes are required:

For the corners, which may be called stiles,

4 pieces, $5/16'' \times 3/4'' \times 8''$,

4 pieces, $5/16'' \times 7/16'' \times 8''$.

For the cross-pieces, which may be called rails,

4 pieces, $5/16'' \times 1\frac{1}{2}'' \times 4\frac{1}{2}''$ (upper rails),

4 pieces, $5/16'' \times 1\frac{3}{4}'' \times 4\frac{1}{2}''$ (lower rails).

All to be of exactly the same length and properly shaped before assembling.

For the horizontal cross slats,

4 pieces $5/16'' \times 3/8'' \times 4\frac{1}{2}''$.

For the muntins (vertical slats),

8 pieces $5/16'' \times 5/8'' \times 5\frac{1}{4}''$.

Prepare all these pieces, remembering that it is easier to work with as long pieces as it is convenient to plane and then to cut these up to the proper lengths afterward. Since there is a considerable number to be cut to the same length, fasten a stop at the proper place in the miter-box and saw off the pieces, measuring mechanically by that means. See Fig. 131.

If these are carefully cut it will not be necessary to dress the ends of the rails or slats. The ends of the stiles should be carefully smoothed. Shape the rails with chisel and spokeshave.

Next lay out and cut and fit the cross-lap joints of the slats. (Directions for making this joint are given on p. 155 of *Handwork in Wood*). Glue these together.

Next make up the corner posts by gluing together, as in Fig. 199.

When dry, dress off the outer surfaces of the joints so that they will be quite flush. The whole may now be assembled.

On a flat board, leaving a space about 1" wider than the entire width of the lantern, nail strips of wood about 9" long parallel to each other, as *A, A*, Fig. 200. Prepare two wedges, *B, B*, 8" long, $5/16''$ thick, and tapering from $5/8''$ wide to a point, and a buffer strip, *C*.

Lay the pieces of one side, outside down, in their proper position in this space. Put in the strip *C* and drive in the wedges *B, B*, making all true and square, and seeing that there is no buckle.

At all the joints drive in $3/16''$ corrugated fasteners. Repeat on all sides. Stain the whole with brown oil stain and rub well.

Find some brown or manilla paper which gives a pleasing color by transmitted light, and glue on the inside of the four sides with liquid glue. Raw silk and grass cloth are also very effective.

Fasten with glue and brads two narrow cleats $5/16''$ square, and 3" long, on the inside of two opposite sides near the bottom, as at *a*, Fig. 201.

On these fasten with brads a strip, *b*, running across the lantern inside. To the middle of this is to be screwed a copper candle holder (socket and pan), made as described on p. 92. The simplest saucer to make is round and hammered convex with a horn hammer into a mold cut out of hard wood.

Screw four small screw-eyes (No. 214½) (14 gage wire, $3/16''$ hole) into each of the upper

inside corners, by means of which and a copper chain or wire the lantern may be hung.

The hanging lantern shown in Fig. 197 is simpler still in construction, since there is no fret-work. In this style of lantern Japanese stencils are used. In making it, buy the four stencils, first,¹²

¹²These can be obtained in New York of O. Shima, 20 East 33rd Street, at a cost of about 25c each.

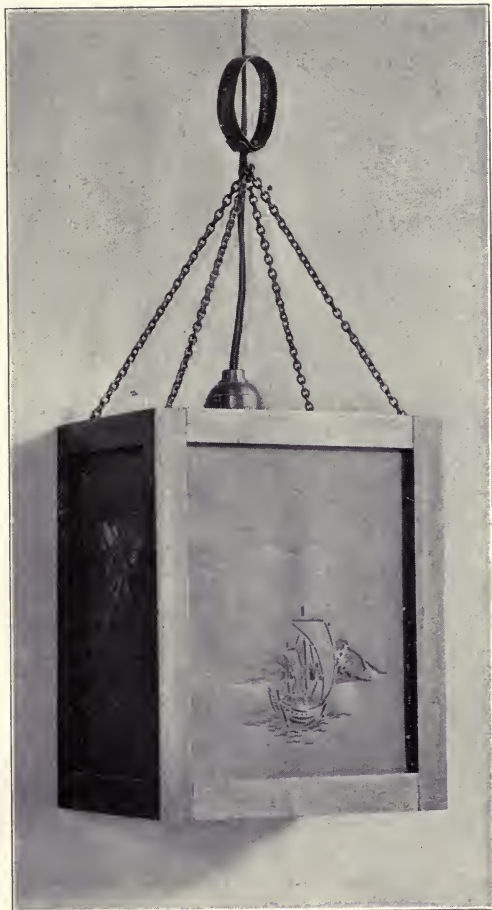

Fig. 197 Hanging lantern.

and make the lantern to fit them. The paper of which these stencils are made is almost opaque. If a more translucent effect is desired, oil the stencils. Or, the stencils, as shown in Fig. 198, may be traced



Fig. 198. Wall lantern.

from the original Japanese stencil on brown writing paper or other suitable material, and then cut out with a sharp knife point on a piece of glass. In this way, fine clear edges can be obtained.

II. *Wall lanterns.*

In making the screen and bracket, shown in Figs. 198 and 202, make the screen first. The stiles and upper rails are all of the same thickness and width, $5/16" \times 3/8"$. The bottom rails are $5/8"$ wide. On the whole the simplest joint for

such small pieces is the end-lap. Dress up all the parts and cut to the desired lengths, (stiles $8\frac{1}{2}"$ long, rails $3\frac{3}{4}"$). The fitting together is a fine delicate job, requiring twelve distinct joints. If the lantern is made larger, say twice as large, the joints may be butt joints and doweled together. (For directions, see *Handwork in Wood*, p. 152, No. 8). Or, it may be put together with corrugated fasteners, as in the hanging lantern (Fig. 200).

To make the end lap joint see *Handwork in Wood*, p. 156, No. 16. When the parts are glued together and dry, the 30° bevel should be planed off on both long edges of all the panels. Make the bottom of the screen $\frac{1}{2}"$ thick in the form shown in the plan in Fig. 202, i. e., half a hexagon, so that its sides shall be just equal to the short (inside) width of the panels.

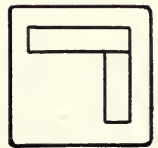

Fig. 199. Corner posts of lantern.

To lay out the hexagon, with a compass, draw a circle whose radius is equal to the desired length of one of the six sides. As only half the circle is required place one leg of the compass on the edge of the board. From the point where the circumference touches the

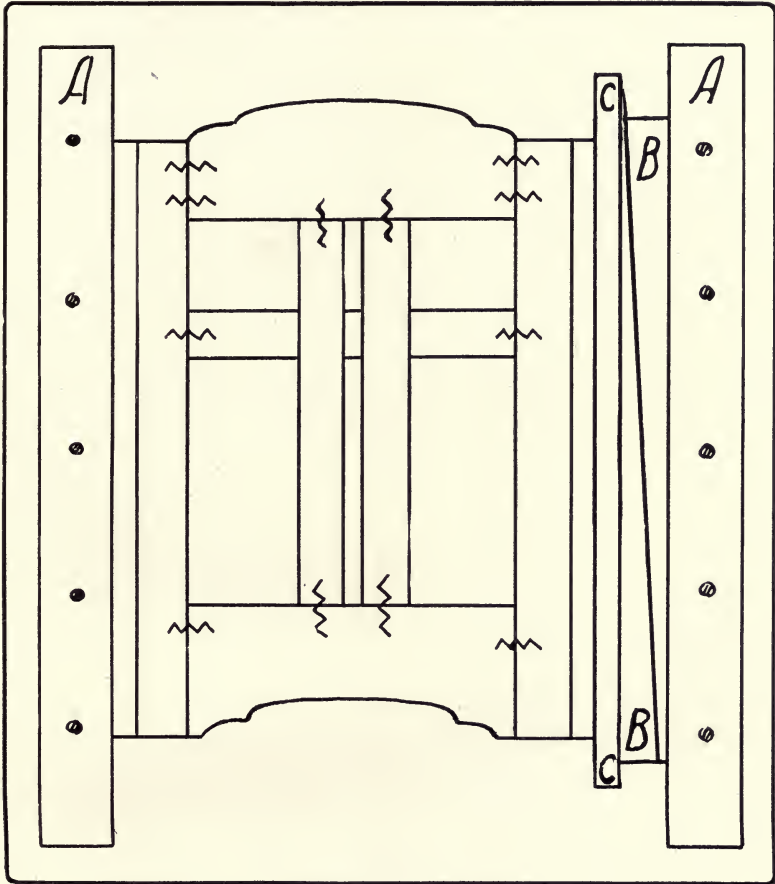

Fig. 200. Method of clamping up the parts.

edge of the board, step off on the circumference a distance equal to the radius. Repeat from the opposite point of the circumference, and connect by straight lines the points thus obtained, *a, b, c, d*, and the half-hexagon desired is drawn. Also inscribe a smaller circle of $2\frac{1}{4}$ " radius to make room for the candle-stick which is fastened to the bracket. See Fig. 202. Saw and plane out this shape.

For gluing the panels together, prepare a few forms of the shape shown in Fig. 203. Put a thin film of glue (liquid glue will do) on those edges of the panels which are to be jointed, and with small brads, (1" No. 18) nail the panels in place to the half hexagon bottom. Clamp the panels together with small handscrews, using the

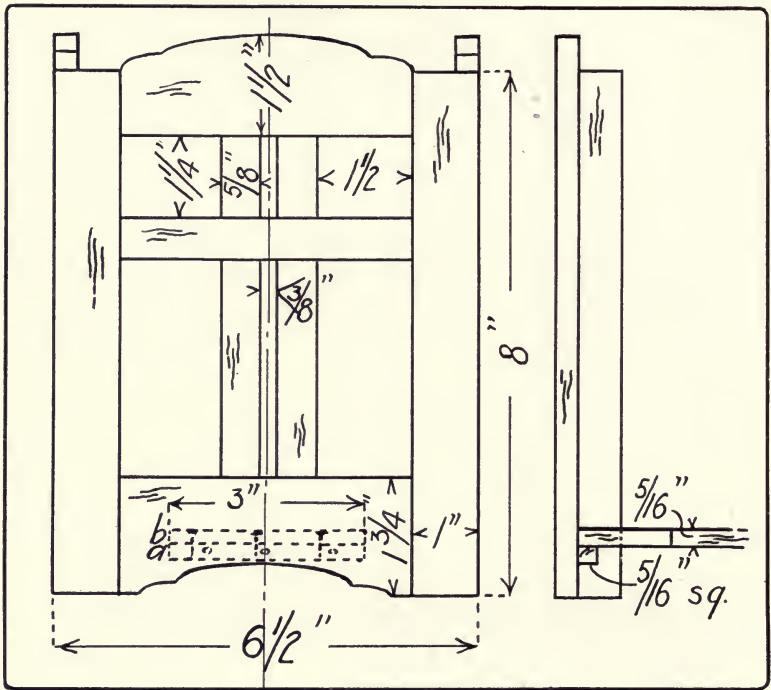

Fig. 201. Working drawing of lantern shown in Fig. 196.

forms just made. See *Handwork in Wood*, p. 171, Fig. 258, and p. 170, 2nd paragraph. When dry, clean up.

The frame should be stained and finished before the stencils are put on. Hence it is better to make the bracket next, so that all the staining may be done together. See below for directions for making the bracket.

The stencils are cut out of sheets of brown paper which fit the insides of the panels. (See p. 152.)

Cut three pieces of silk of the same size as the stencils, and of an harmonious tint, and tack both paper and silk, (silk toward the

candle) to the inside edges of the panels by means of thin strips of wood and small brads, say $\frac{1}{4}$ " , No. 20. Tack these strips all around the inside of each panel.

The shelf of the bracket should conform in design to the lantern. The material for the bracket may also be $\frac{5}{16}$ " thick. If possible

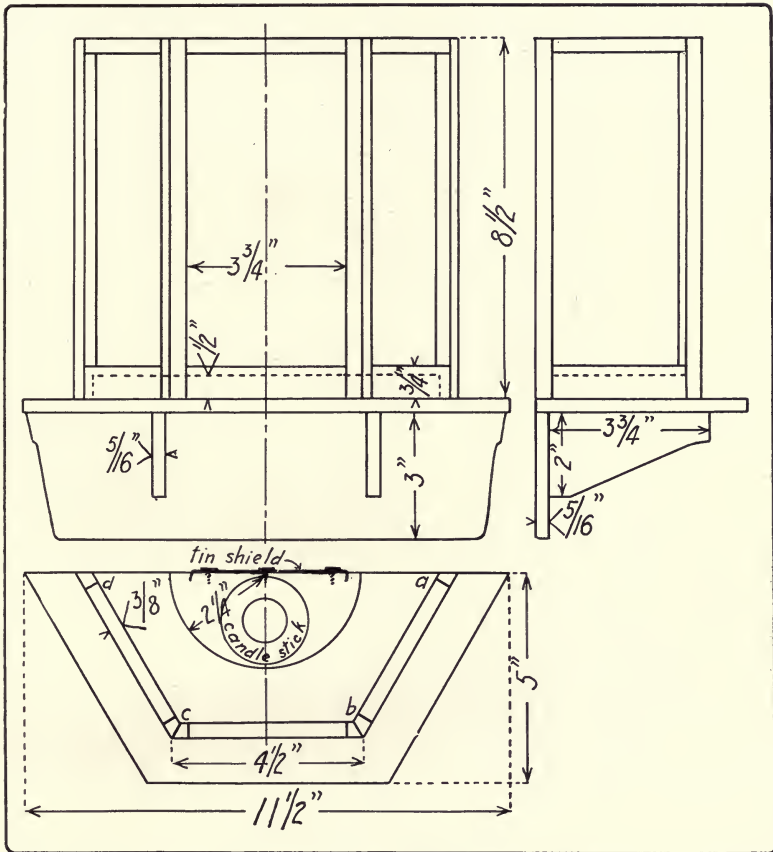

Fig. 202. Working drawing of lantern shown in Fig. 198.

make all the parts, shelf, back, and two supports, out of one board, planing first the working face and working edge, and the exact thickness. Lay out the plans on this and cut out roughly. The shelf overhangs the back when assembled. The back and shelf can now be finished exactly to shape by means of the plane, or if irregular in

shape with the spokeshave and chisel also. In order to make the two supports exactly alike, glue them together thus: Put a touch of glue

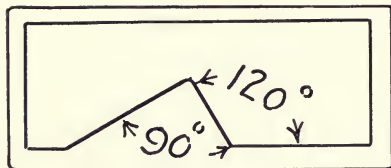

Fig. 203 Block for clamping lantern panels together.

at several points on one piece, press a piece of paper over it, put glue on the other side of the paper at the points opposite those already glued, lay on the other piece and clamp together. When dry, proceed as if they were one piece, finishing carefully. When shaped, they may be pried apart with a chisel, and what little glue adheres may be planed off. Or, the two pieces may be handscrewed together, while

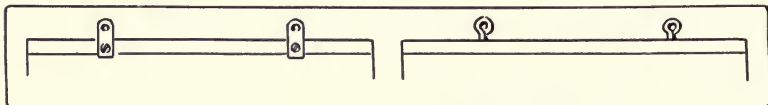

Fig. 205. Methods of hanging the bracket.

they are shaped. Assemble the parts of the bracket as in Fig. 204. First draw light pencil lines on the top of the shelf and on the back of the back, to indicate where the brads (1" No. 18) are to be driven into the supports, start two brads along each of these lines, driving them thru the boards until the points prick thru, and also driving brads thru the shelf to go into the back.

Now, holding one of the supports in the vise, lay the back on it in its proper place and drive in the brad nearest the shelf. By means of the try-square hold the back exactly in place over this support, and drive in the other brad. Repeat with the other support.

Next brad the shelf and back together, having the shelf overhang the back. See that the supports are squarely in place and drive home the brads thru the top into them. Stain the bracket to match the screen.

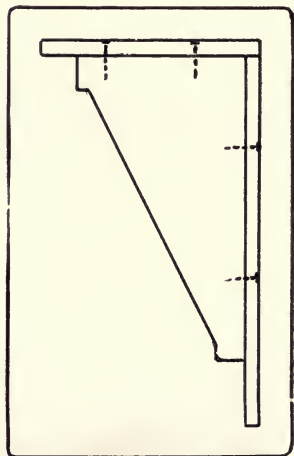

Fig. 204. Location of brads.

For hanging the bracket, gain into the back small copper or brass strips with holes in them, as shown in Fig. 205, or insert small screw-eyes (No. 214½) at the back edge of the shelf. Place these hangers so as not to interfere with the screen.

If electricity is available it is of course much safer to have a small electric light bulb take the place of the candle.

INDEX

- Ammonia, 100, 110.
Ash, White, 4, 18.
Auger-bit-gage, 105.
Bastard board, 15.
Batchelder, Ernest A. Design in Theory and Practice, 22, 124.
Batter, 112.
Beads, 78.
Beauty, 23.
Bench, 28, 29.
Bird-houses, 146, 147.
Bit holder, 64.
Blotter-holder, 132, Chap. XI, 133.
Board foot, 16.
Board measure, 16.
Boring, 62, 64, 91, 103, 104, 108, 117, 118.
Boxes, Chap. XII, 137.
Bracket, 155.
Brads. See nailing.
Bruises in wood, 108.
Dowel-plates, 103, 106.
Candlestick, 82, Chap. VII, 83.
Carving, 68, 124.
Chamfer, 42, 80, 91.
Chestnut, 9, 99.
Chiseling, 47, 60, 63, 111.
Clamps, 105.
Color, 25, 67, 68.
Comb-grain, 15.
Combustibility of wood, 13.
Compass holder, 64.
Composition, 22, 24.
Construction, 21, 22, 35, 133.
Convenience, 23.
Copper, 9, 40, 83, 92.
Corrugated fasteners, 150.
Cove, 89, 130.
Cut-out, 70.
Cylinder, copper, 93.
Cypress, 3, 9, 17, 35, 99.
Day, Lewis F. The application of ornament 22.
Decoration, 26, 36, 78, 83, 124, 129, 133, 137.
Depth-gage, 127.
Design, 9, 10, 21, 22, 125.
Dow Arthur W. Composition, 22, 65.
Dowel-pins, 103, 106.
Dowel-rod, 133.
Embellishments, 83, 149.
Emery cloth, 94, 95.
Equipment, 29.
Essentials, Fixing of, 26, 35, 83, 115, 123, 133, 137, 149.
Figure, 16.
File, 130.
Filler, 145.
Finish, 25, 27, 37, 56.
Flower-pot stands, 97.
Fuming, 100, 110.
Gaging, 43.
Glass cutting, 76, 77.
Glue, 33, 74, 79, 102, 105, 108, 140, 142, 143, 145, 150, 156.
Gouge, 89, 126.
Grain, 16.
Gum, Sweet, 4, 9, 19, 83, 123, 133.
Handscrews, 19, 105, 110, 138.
Handwork in wood, 17, foot note 25, 29, 33, 38, 39, 43, 44, 45, 55, 59, 60, 61, 62, 71, 73, 74, 75, 76, 79, 87, 91, 92, 94, 102, 104, 105, 109, 111, 113, 118, 119, 127, 128, 130, 131, 137, 138, 139, 143, 145, 146, 149, 152, 154.
Hexagon, Laying out, 153.
Hickory, 9, 115.
Hinges, Setting, 143.
Inlay, 137.
Japanese prints, 65, 70.
Japanese stencils, 151.
Joints, 22.
Joint:
 Butt, 9, 90, 141.
 Cross-lap, 9, 83, 87, 99, 102, 150.
 Draw-bolt, 28.
 End-lap, 9, 51, 152.
 Ledge, 9
 Miter, 9, 51.
 Mortise and tenon, 28, 90, 117.
 Notched, 111.
 Rabbet, 142.
 Rubbed, 9, 109.
Lanterns, 148, Chap. XIII, 149.
Lathe, 104, 135, 136.
Leaf press, 57.
Letter-tray, 56, 57.
Line, 24.
Mahogany, 4, 9, 14, 19, 69, 83, 88, 137.

- Mallet, 10, Chap. IX, 115.
 Maple, 9, 69, 115.
 Margins, 65, 67.
 Marking gage, 43, 44, 45, 49, 61, 143.
 Mass, 23.
 Mat 65, 66, 68, 69.
 Material and form, 22.
 Miter box, 51, 55, 64, 74, 103, 105, 150.
 Moisture in wood, 14.
 Mold for hammering copper, 97.
 Moldings for pictures, 78, 80.
 Mounting of pictures, 69, 70.
 Nailing, 14, 51, 53, 54, 75, 90, 91, 104,
 140, 145, 156.
 Nail set, 53.
 Nail set holder, 64.
 Nosing, 78.
 Notan, 24.
 Oak, White, 3, 9, 14, 18, 69, 137.
 Octagon, Laying out, 109, 110.
 Ogee, 131.
 Oil, 9, 25, 64, 84, 100, 110, 131.
 Pan, 92, 94, 151.
 Paper, Cover, 69.
 Pencil holder, 64.
 Paper, Manilla, 77, 151.
 Picture frame, Chap. VI, 65.
 Picture-frame-clamp, 10, 58, 59, 74.
 Pine, White, 3, 9, 14, 17, 70, 87.
 Pith rays, 14.
 Plane, Adjustment of, 39, 41, 42.
 Planing, 39, 41, 42, 46, 48, 63, 102,
 120, 141, 150.
 Plates, Brass, 109.
 Polish, French, 131.
 Poplar, Yellow, 4, 9, 18, 59, 149.
 Properties of wood, 13, 14.
 Proportions, Refining of, 26, 36, 83,
 99, 124, 137.
 Quarter-sawing, 15.
 Rabbetting, 71, 73, 138, 139.
 Raymond, Geo Lansing. Proportion
 and Harmony of Line and Color,
 22.
 Rift board, 15.
 Rings, Annual, 14, 117.
 Sandpaper, 50, 75, 88, 108, 128.
 Saw, Back, 63, 74, 75, 108, 111, 121,
 139, 143.
 Saw, Coping, 95.
 Sawing, Cross cut, 33, 41, 119.
 Sawing, Rip, 45, 60, 120.
 Saw, Turning, 111.
 Scoring, 48.
 Scrap-basket. Chap. IV, 35.
 Scraper, 128.
 Screw, 64.
 Screw-box, 133.
 Screw eyes, 77, 151, 157.
 Shellac, 9, 25, 117, 131.
 Shrinkage of wood, 14, 15.
 Skill, 9.
 Slash-grain, 15.
 Slip-feather, 75.
 Snips, 92, 94.
 Socket, 92, 95, 151.
 Soldering, 93.
 Soundness of construction, 22.
 Spline, 75.
 Spoke shave, 61, 120, 121, 130.
 Spruce, 3, 17.
 Square, Steel, 112.
 Stain, 9, 33, 56, 76, 92, 110, 145, 150.
 Steel wool, 121, 131, 145.
 Structure and design, 22.
 Structure of wood, 14.
 Supplies, 33.
 Tables, Small, 98, 100.
 Taborets. Chap. VIII, 99.
 Tapering, 89.
 Tee bevel, 52, 63, 119.
 Templet, 119, 127, 135.
 Tools, 29, 30.
 Trays, 122, Chap. X, 123.
 .ray, Glass, 80.
 Try-square, 40, 43, 44, 49, 117.
 Turning saw, 111, 129.
 Upholstery nails, 55.
 Utility and beauty, 26.
 Varnish, 25.
 Vise, 29, 30.
 Walnut, Black, 9, 83, 88, 137.
 Warping of wood, 15.
 Wax, 9, 57.
 Wedge, Method of making, 121.
 White wood, 9. See Poplar, Yellow.
 Wire, Binding, 93, 94.
 Wood, 13.
 Wood and Forest, 16, foot note 26,
 118.
 Woods, Common, 3, 4.

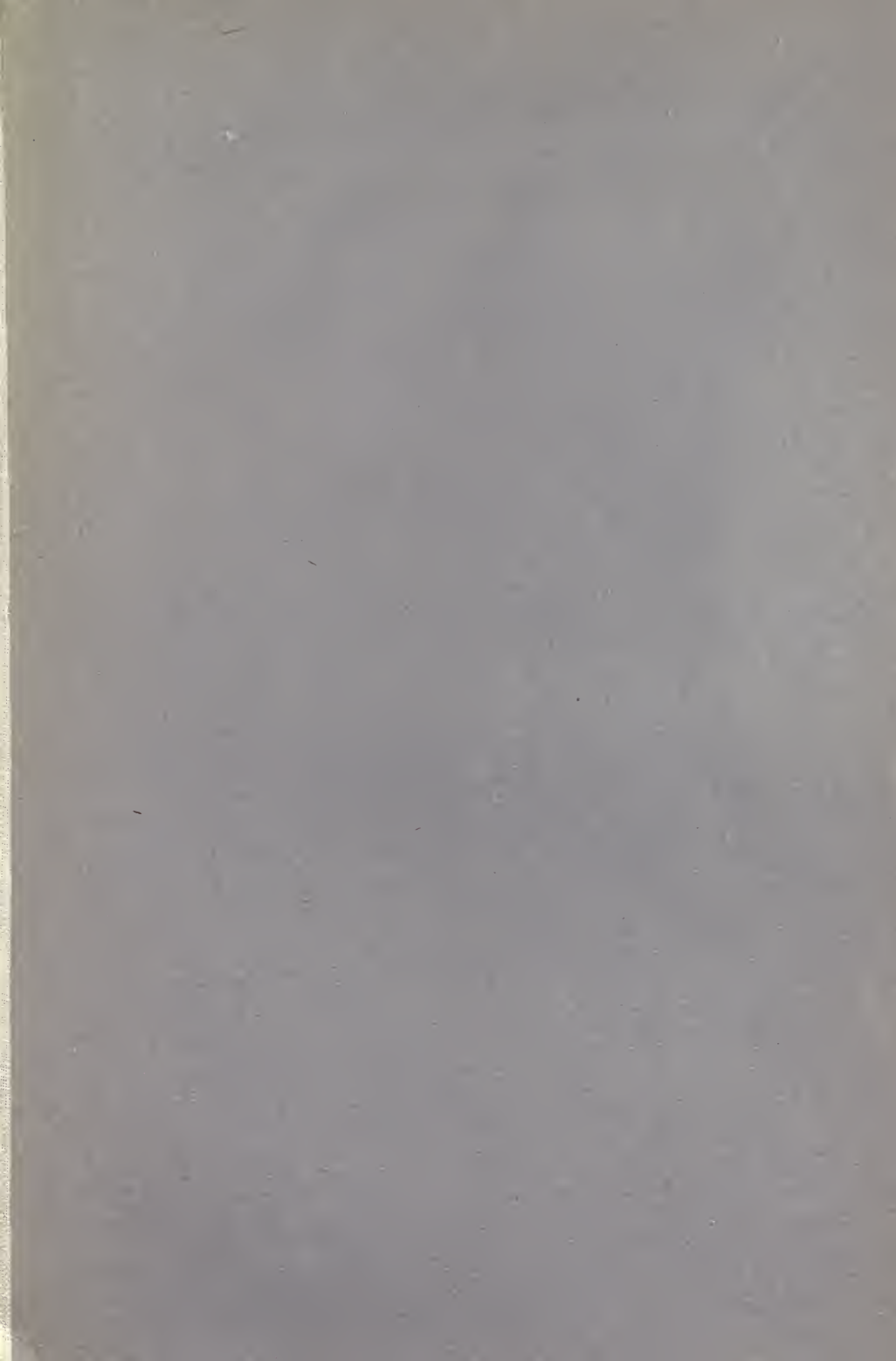

14 DAY USE
RETURN TO DESK FROM WHICH BORROWED
LOAN DEPT.

This book is due on the last date stamped below,
or on the date to which renewed. Renewals only:
Tel. No. 642-3405
Renewals may be made 4 days prior to date due.
Renewed books are subject to immediate recall.

REC'D LD MAR 31 71 -11 AM '71

MAY 18 1971 21

REC'D LD MAY 10 71 -2 PM 82

Due end of SUMMER Period JUL 22 71 6 2
subject to recall after —

RETURNED TO

SEP 24 1971

LOAN AHC

LD21A-50m-2,'71
(P2001s10)476—A-32

General Library
University of California
Berkeley

(6889s10)476B

University of California
Berkeley

416033

TT.1800
N7

UNIVERSITY OF CALIFORNIA LIBRARY

